

\$4.⁵⁰

OWNER'S MANUAL

for the
TROY-BILT®
Roto Tiller
Power Composter
HORSE™ MODEL



THIS TROY-BILT OWNER is chopping up and tilling under all of his garden residues, literally turning his *whole* garden into a fabulously fertile "compost pile"! Please see the Back Cover for more details on just why your Troy-Bilt is actually *two* machines in one — a superior rotary tiller *and* a compost chopper-shredder.

Troy-Bilt® is a registered trademark of Garden Way Manufacturing Company, Inc., Troy, New York
HORSE™ is a trademark of Garden Way Manufacturing Co., Inc.

BrentChalmers.com



The Troy-Bilt Tiller Factory in Troy, N.Y.

WHY WE CALL IT THE HORSE MODEL TROY-BILT® ROTO TILLER- POWER COMPOSTER

Throughout this **OWNER'S MANUAL** or other Troy-Bilt® sales literature and Order Forms, we call your tiller the **HORSE MODEL TROY-BILT®**. The name aptly describes its work-horse ruggedness and distinguishes this model from other models that have been available in the past, or might be produced in the future.

Perhaps you already know that our company, Garden Way Manufacturing Company, Inc., is a once-removed outgrowth of the original Rototiller Corp., which was also a Troy, New York based company from 1934 until 1960.

Rototiller Corp. introduced rotary tillage to the United States in the early 1930's, and led the field for over 25 years with many unique and important developments in roto tilling equipment. Rototiller Corporation was sold in 1960, and moved out of Troy at that time.

The business of supplying replacement parts to former Rototiller dealers and thousands of Rototiller owners was sold to our present company, which at that time was called Watco Machine Products Corp. In 1968, we changed our name to Garden Way Manufacturing Company, Inc., to more aptly describe the company's full commitment to promoting home vegetable gardening as a better way of life.

In 1961, George W. Done, who was then president and a founder of our Watco Machine Products Corp., designed a new medium size roto tiller, which he called the **TROJAN HORSE MODEL**. This machine (which is much the same machine we build today, with several small but important improvements) combined all of the best ideas from George Done's 25 year experience as chief engineer and designer for the original Rototiller Corp.

In 1963, when we were still known as Watco Machine Products Corp., we were forced to change the name of our **TROJAN HORSE MODEL** because it conflicted with the product trademark of a large earth-moving equipment manufacturer. It was then that we chose **TROY-BILT®** as our tiller trademark, along with the **HORSE MODEL** designation. Over the years, our **TROY-BILT® HORSE MODEL** has been continually refined and improved to the point that its performance and reliability have long been recognized by many thousands of serious vegetable gardeners as being unmatched by any other tiller of its size or design.





Our Service Department is as close as your phone.

Have a question about servicing your tiller...

or how to operate it... or gardening in general?

We're as close as your telephone, with our 24-hour HOTLINE ...

Here's what to do:

1 Look at the INDEX starting on page 4 to find the listing that covers the subject you're concerned with. Then, turn to those pages listed and see if the solution to your problem is listed there or on other pages in that general category—Possibly your search will lead you to another section of THIS MANUAL where you will find a solution.

2 Next, if you haven't found your answer, write to our service department.

3 Or, if you can't find your answer in the book and it's urgent, call us here at the factory on our 24 HOUR SERVICE HOT LINE: Area Code 518, 235-6010, Troy, New York.



Naturally each Troy-Bilt part is always in stock, ready to go at a moment's notice. Call anytime of the day or night or write for immediate, speedy shipment.

OUR TELEPHONE SERVICE HOT LINE is in operation 24 hours a day, 365 days a year. It is attended personally from 8:00 AM to 4:30 PM (Eastern Time), Monday through Friday. For other hours of the day, and for weekends and holidays, an automatic answering machine will record your message. One of us will take care of your questions the following work day.

The whole idea behind the **TROY-BILT® SERVICE "HOT LINE"** is to get parts, attachments and service advice out to you just as quickly as possible; also, to answer any questions you may have about tilling or gardening, by phone or by letter, depending upon what is needed.

Nothing is more important to all of us here at the Tiller Factory than making sure that every single Troy-Bilt® Owner is completely satisfied 100 per cent of the time. You're always entitled to first rate service. Please know that we will do our very best to see that you get it at all times. Thank you.

Dean Leith, Jr.

Dean Leith, Jr., Sales Manager



We keep you up-to-date at least once a year on service hints, latest developments at the factory and gardening advice, plus a helpful exchange of news and tips from other Troy-Bilt owners everywhere.

BrentChalmers.com

HOW TO FIND YOUR TILLER'S SERIAL NUMBER

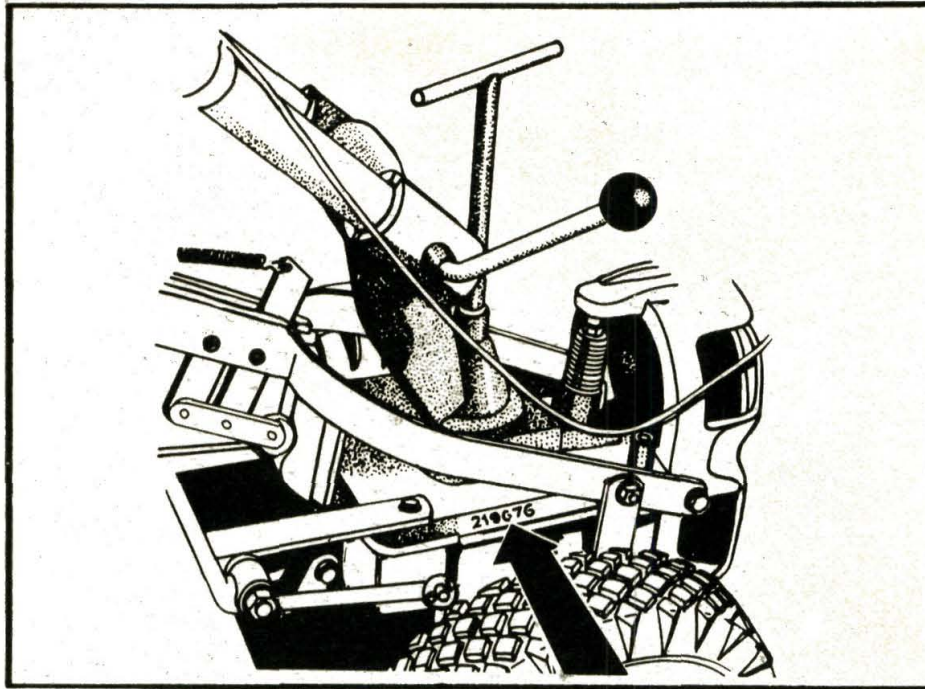

LOOK HERE...Look on the Transmission Case,
Part No. 1000, on right side above wheel axle.

RECORD YOUR TILLER SERIAL NUMBER HERE:

My Troy-Bilt Tiller is number _____

WARNING TO ALL CALIFORNIA TILLER OPERATORS

Under California Law, you are not permitted to operate an internal combustion engine using hydrocarbon fuels on any forest-covered, brush covered, or grass covered land, or land covered with grain, hay or other flammable agricultural crop, without an engine spark arrestor in continuous effective working order. The engine that runs your tiller, like most garden or lawn equipment, is an internal combustion engine that burns gasoline (a hydrocarbon fuel); therefore, to operate a tiller under the conditions described above, the engine must be equipped with a spark arrestor muffler in proper working order. The spark arrestor must be attached to the engine exhaust system in such a manner that flames or heat from the system will not ignite flammable material. Failure of the operator to comply with this regulation is a misdemeanor under California law. For a spark arrestor muffler, see your local Engine Service Dealer.

VERY IMPORTANT

- Your **LIMITED WARRANTY** goes into effect when you have filled out the **TILLER OWNER WARRANTY REGISTRATION FORM** and have returned it to us.
- **PLEASE**, fill out the postage paid **WARRANTY CARD** and mail it to us right away, so we will know that you have received your tiller and can register your warranty!

TABLE OF CONTENTS

SERVICE HOT LINE	1
HOW TO FIND TILLER SERIAL NUMBER	2
INDEX	4
INTRODUCTION	11
SECTION 1 EASY ASSEMBLY OF YOUR TROY-BILT TILLER	15-27
Six easy steps to get your tiller ready to use in the garden	
SECTION 2 TILLER CONTROLS	28-36
Photos and sketches locate tiller controls and show you how to operate	
SECTION 3 SAFETY PRECAUTIONS FOR THE OPERATOR	37-38
Be alert to safety measures. Please read more than once	
SECTION 4 ENGINES, ENGINE CONTROLS & OPERATION	39-55
SECTION 5 OPERATING THE TILLER & SPECIAL TROY-BILT METHODS FOR EASIER, MORE ENJOYABLE GARDENING	56-76
SECTION 6 TILLER OPTIONS & ATTACHMENTS	77-91
Explains tires, chains, Dozer Blade & Furrower	
SECTION 7 TILLER & ENGINE MAINTENANCE	92-122
SECTION 8 HOW TO REMOVE & REPLACE COMMON ASSEMBLIES	123-165
Replacing wheels, oil seals, tines, engine	
SECTION 9 TROUBLESHOOTING TILLER & ENGINE, TILLER & ENGINE SPECIFICATIONS	166—176
Identifies symptoms of a problem and refers you to a solution—often to pages of text with photos to assist you	
LOCATING ENGINE MODEL & SPECIFICATION NUMBERS	173 & 175
LIMITED WARRANTY—ON TILLER	BACK INSIDE COVER
LIMITED WARRANTY—ON ENGINE	BACK INSIDE COVER
FACTORY REBUILDING AGREEMENT	BACK INSIDE COVER

HELPFUL INFORMATION ON USING THE INDEX

This Index has been designed to help you locate information in your OWNER'S MANUAL. All the subjects are listed in alphabetical order from A to Z. Also, we have cross-referenced general names and terms wherever possible.

To Locate A Subject When You Know Its Specific Name: Take the *first letter*, in the *first name*, of the subject, and look under the columns titled *Description*, until you find the alphabetical group that contains the *first letter*. (Example: To locate the subject "Throttle Cable," you would take the letter T in Throttle, and then find the alphabetical group under T and find the word Throttle.

To Locate A Subject When You Don't Know Its Specific Name: Try to think of a name or a

term that more generally describes the subject. (Example 1. The subject "Throttle Cable" also can be found by its more general name, "Cable.") (Example 2. The subject "Bolo Tines" also can be found by the more general names, "Tines" or "Blades.") When you have located a subject by its general name, you will then be referred to its specific name by the phrase, "see ... (name of subject)."

After Locating A Subject In The Index: Refer to the columns at the right which are titled *Section* and *Page*. The numbers in the column labelled *Section* refer to what Section(s) the subject appears in. The numbers in the column labelled *Page* indicate on what page(s) that subject appears.

INDEX

DESCRIPTION	SECTION	PAGE	DESCRIPTION	SECTION	PAGE
A			B		
Adjustment Block (Belt Tightening)			Bar Tread Tires	(5)	74
See Photos 2/3, 2/4, 2/5	(2)	29	(6)	77
.....	(7)	95-97	Battery (also see Electric Start)	(1)	24-27
Air Cleaner-			New, Won't Start	(1)	26
6 HP Tecumseh	(1)	17	Belts-		
.....	(4)	41-48	Adjusting	(7)	98-101
7 HP Kohler	(4)	49	Check for Tightness	(7)	95-96
.....	(7)	113	Installing	(7)	98-101
Keeping Clean (All Models)	(4)	121	Performance	(7)	95-96
Regular Service (All Models)	(7)	113, 121	Removing	(7)	98-100
Service, Dry Element Type	(7)	112	Service Schedule	(7)	121
Service, Polyurethane Sponge Type ..	(7)	107	Blades (see Tines)		
Assembling New Tiller	(1)	15-27	Bolo Tines-		
Attachments and Options	(6)	77-91	Assembly On Holders	(8)	137-138
Authorized Engine Service Dealers-			Description & Function	(5)	61
All Models	(4)	53	Installing Tines	(8)	139-140
Axle, Wheel—Replacing Oil Seal	(8)	120-121	Maintenance	(7)	95
			Removing	(8)	141
			Bolts & Nuts, Maintenance	(7)	93-94
			Broadcast Planting in Wide Rows	(5)	73
			Buckwheat	(5)	69
			Bumper Description & Function	(6)	86-87

INDEX

DESCRIPTION	SECTION	PAGE	DESCRIPTION	SECTION	PAGE
C			Plowing Suggestions (6) 85		
Cable (see Throttle Cable)			Drag Bar (see Depth Regulator)		
(for Battery Cable, see Electric Start)			Drive Shaft, Transmission-		
Carburetor-			Adjusting Play (8) 133-135		
Adjusting (All Engines) (7) 113-15			Loose (8) 133		
6 HP Tecumseh (4) 43			Replacing Oil Seal (8) 131-133		
7 HP Kohler (4) 51			Shimming (8) 133-135		
Chains (see Tire Chains)		 (4) 49		
Choke-			Dry Element Air Cleaner (7 HP Engine) . (7) 113		
6 HP Tecumseh (4) 42			E		
7 HP Kohler (4) 51			Earthworms (5) 67		
Cleaner, Air (see Air Cleaner)			Eccentric Shaft, External Lubrication ... (7) 92		
Clutch Lever (see Forward/Reverse)			Electric Start, 6 HP Engine-		
Clutch Spring (part #1122) (1) 10, 13			Battery (1) 24-27		
Composting-			Battery Storage (4) 47		
Leaf Compost (5) 72			Cables, Battery (1) 26-27		
Power Composting (5) 68			Care & Maintenance of System (7) 117-120		
Cooling Fins, Keeping Clean (4) 34, 53			Diodes, Rectifier (see Rectifier, below)		
..... (7) 115, 121			Key Switch or Wires, If Faulty (7) 117-119		
Controls-			Preparation & Operation (1) 24-27		
Engine (4) 39-55			Rectifier, Diode (1) 24-27		
Tiller (2) 28-36		 (4) 48		
Corn Furrowing to Plant (6) 89			Solenoid (7) 117-119		
Cornstalks, Tilling Under (5) 75-76			Starting (4) 47		
Cover Crops (see Gardening)			Starting Problems (7) 119		
Crankcase Breather (6 HP Engine) (7) 116-117			Engine, 6 HP Tecumseh-		
Cultivating Tines-			Air Cleaner (4) 40, 45		
Description & Function (5) 62			Air Cleaner, Servicing (7) 112, 121		
Maintenance (7) 95			Basic Information (4) 39		
Replacing & Removing (8) 142-145			Carburetor (also see Carburetor) (4) 43		
D			Choke (4) 42		
Damage, Freight (1) 18			Electric Start (see Electric Start) (4) 46, 47		
Depth Regulator (2) 31, 35			Gasoline (4) 43, 53		
Depth, Tilling (5) 59, 67			Governor (4) 55		
Dipstick, Engine Oil (4) 44, 49			Head Bolt Tightening (4) 44-45		
Disc, Reverse (see Reverse)			Oil, Changing (4) 44		
Dozer/Snow Blade-			Oil Level & Dipstick (8) 148-153		
Description & Function (6) 80-85			Removing Engine (8) 153-154		
			Replacing Engine (4) 53		
			Service Dealers, Authorized (4) 43		
			Shutoff Clip (9) 175		
			Specifications (4) 47		
			Starting (7) 119		
		 (7) 119		
			Starting Problems (7) 119		

INDEX

DESCRIPTION	SECTION	PAGE	DESCRIPTION	SECTION	PAGE	
Stopping	(4)	47	G			
Throttle Cable (see Throttle Cable) ...	(4)	42				
Troubleshooting	(9)	170-173				
Engine, 7 HP Kohler-				Gardening, Troy-Bilt Methods-		
Adding Oil	(4)	49-50		Broadcast Planting in Wide Rows ...	(5)	73
Air Cleaner	(7)	113		Buckwheat	(5)	69
Carburetor Adjustments	(7)	113-116		Cover Crops	(5)	68-72
Governor	(4)	52		Earthworms	(5)	67
Head Bolt Tightening	(4)	55		Footprints/Wheelmarks, Avoiding	(5)	60,66
Key Switch	(1)	26		Green Manuring	(5)	68-73
Removing Engine	(8)	148-153		Leaf Compost	(5)	72
Replacing Engine	(8)	153-154		Mulch	(5)	70
Replenishing Oil	(4)	46		Organic Matter	(5)	67
Service Dealers, Authorized	(4)	48		Organic Matter, Sources of	(5)	68
Specifications	(9)	176		Planting	(5)	73
Starting	(4)	46-47	Power Composting	(5)	68	
Starting Problems	(7)	114-115	Saving Space	(5)	73	
Stopping	(4)	47	Soil & Moisture Conditions	(5)	74	
Throttle Cable (see Throttle Cable) ...	(4)	46	Tilling:			
Troubleshooting	(9)	170-173	Across Slopes	(5)	64	
Engine, Basic Information	(4)	31, 32	Depth	(5)	59, 67	
Engine Controls	(4)	31-50	In Garden	(5)	56	
Engine Cooling	(4)	48, 50	Patterns	(5)	59	
Engine Crankcase Breather (6 HP Eng.) .	(7)	111-112	Traction	(5)	74	
Engine Model Number, Locating	(4)	48	Turning in Green Manure Crops	(5)	68	
To Record	(6)	173	Under Cornstalks	(5)	75-76	
Engine Oil (see Oil, Engine)			Uphill	(5)	65	
Engine Pulley (see Pulleys, Engine)			Vertically on Slopes	(5)	62	
Engine, Service Reminders	(7)	106-108	Gasoline-			
Engine Specifications	(9)	175-176	6 HP Tecumseh	(4)	46	
Engine Troubleshooting	(9)	170-173	7 HP Kohler	(4)	52	
F			Gear Oil, for Tiller (see Oil, Transmission Gear)			
Factory Rebuilding Agreement	Inside Back Cover		Governor-			
Fins, Cooling (see Cooling Fins)			6 HP Tecumseh	(4)	43, 53	
Footprints, How to Avoid	(5)	60, 66	7 HP Kohler	(4)	52	
Forward Motion	(2)	29	Grease, Lubrication Points	(7)	92	
.....	(5)	56	Green Manure Crops	(5)	68-72	
Forward/Reverse Lever	(1)	21				
.....	(2)	29, 33				
Free Wheeling	(2)	30				
Freight Damage	(1)	18				
Furrower- (see Hiller/Furrower)						

INDEX

DESCRIPTION	SECTION	PAGE	DESCRIPTION	SECTION	PAGE
H			L		
Handlebars-			Leaf Compost	(5)	72
Attaching & Adjusting	(1)	13-14	Levers-		
Location & Functions	(2)	24, 27-28	Clutch, Forward/Reverse	(2)	29, 33
Head Bolts-			Forward/Reverse	(2)	21, 25
6 HP Tecumseh	(4)	55	Wheel Speed Shift	(2)	30, 34
7 HP Kohler	(4)	55	Loose-		
Hiller/Furrower			Bolo Tine	(9)	169, #15
Description & Function	(6)	88-91	Bolts & Nuts	(7)	93-94
Attaching	(6)	91	Drive Shaft	(8)	133
Gardening Techniques	(6)	88-90	End Cap	(8)	135
Hood, Tiller-			Tiller Housing Cover	(8)	131
Removing	(8)	136	Wheel:		
Replacing	(8)	162	Snap Ring	(9)	168, #12
Horse Model-			Lubrication Points	(2)	36
6 HP Tecumseh	(4)	41-48	(7)	92
6 HP Tecumseh, Electric Start	(4)	47-48			
7 HP Kohler	(4)	49-52			
I			M		
Idle Speed Adjustment	(7)	114-115	Maintenance-		
Ignition System-			Air Cleaners	(7)	113, 121
Service	(7)	121	Belts (see Belts)		
Troubleshooting	(7)	119	Bolts & Nuts	(7)	93-94
J			Cooling Fins	(7)	113, 121
Jumps Out of Gear	(9)	166, #1	Electric Start System	(7)	117-120
.....		167, #2	Engine, Cleaning	(7)	110-111
Jumping Solenoid with Wires	(7)	117-119	Engine, General Maintenance	(7)	122
			Engine, Quick Reminders	(7)	111
			Ignition Service	(7)	121
			Oil Service	(7)	121
			Reverse (see Reverse)		
			Throttle Cable (see Throttle Cable)		
			Tiller & Tines	(7)	95
			Transmission	(7)	121
			Manure, Green	(5)	68-72
			Missing Parts	(1)	18
			Motor Oil (see Oil, Adding to Engine)		
			Mulch	(5)	70
K			N		
Kohler Engine (see Engine, 7 HP Kohler)			Neutral	(2)	29

INDEX

DESCRIPTION	SECTION	PAGE	DESCRIPTION	SECTION	PAGE
O			Potatoes, Furrowing & Planting	(6)	88
Oil, Engine-			Power Adjustment Screw (Engine)	(7)	114-115
Adding to:			Power Composting	(5)	68
New Engines	(1)	20	PTO—Power Take-Off Shaft	(8)	151
6 HP Tecumseh	(1)	20	Pulleys-		
7 HP Kohler	(4)	21	Drive Shaft	(8)	132-133
Changing:			Drive Shaft Snap Ring	(8)	132
Intervals	(4)	40	Engine (Remove & Replace)	(8)	148-154
6 HP Tecumseh	(4)	44	Functions	(2)	33-34
7HP Kohler	(4)	50	Lower Drive (Remove)	(8)	132-133
Oil Level & Dipstick, 6 HP Tecumseh	(4)	44	Shimming Engine	(8)	151
7 HP Kohler	(4)	49	Upper & Lower, Alignment	(7)	103
Recommended Rating	(1)	20	Q		
.	(4)	50	R		
Oil, Lubrication Points	(2)	36	Rebuilding, Factory Agreement	Inside Back Cover	
.	(7)	92	Rectifier (Diode)	(1)	24-27
Oil Seals, Removing/Replacing-			(4)	48
Front End (Drive Shaft)	(8)	131-132	Removing & Replacing-		
Tiller Housing	(8)	127-130	Bolo Tines	(8)	137-141
Tiller Housing Cover	(8)	131	Cultivating Tines	(8)	142-145
Tiller Shaft	(8)	127-130	Engine	(8)	148-154
Transmission Drive Shaft	(8)	131-132	Hood, For Tiller	(8)	136, 162
Wheel Shaft (Wheel Axle)	(8)	124-126	Lower Drive Pulley	(8)	132-133
Oil, Transmission Gear-			Oil Seal, Drive Shaft	(8)	131-132
Adding	(1)	19	Oil Seals, Tiller Shaft	(8)	127-130
Changing	(1)	19	Oil Seals, Wheel Axle	(8)	124-126
Leaks, Checking For	(8)	127	Pointed Pick Tines	(8)	145-147
Oil Fill Hole Location	(1)	19	Reverse Disc (see Reverse)		
.	(2)	36	Throttle Cable (see Throttle Cable)		
Operating the Tiller (see Gardening)	(5)	56-76	Tiller Housing Cover	(8)	131
Options & Attachments	(6)	77-91	Transmission	(8)	155-165
Organic Matter	(5)	67	Wheels (All Types)	(8)	123
P			Repairing (see Removing & Replacing)		
Pick Tines (see Pointed Pick Tines)			(see items or parts involved)		
Planting (see Gardening)			Reverse-		
Plowing (see Dozer/Snow Blade)			Adjustment Check	(7)	102-103
Pointed Pick Tines-			Aligning Disc & Lower Pulley	(7)	103
Description & Function	(5)	61-62	Motion	(2)	29, 33
Maintenance	(7)	95	Removing & Replacing Disc	(7)	105, 106
Replacing & Removing	(8)	145-147	Servicing Disc	(7)	121
Polyurethane Air Cleaner	(7)	112			

INDEX

DESCRIPTION	SECTION	PAGE	DESCRIPTION	SECTION	PAGE
S			Throttle Cable-		
Safety	(3)	37-38	Attaching (All Models)	(1)	22
Seals (see Oil Seals)			Attaching, Adjusting, Maintenance:		
Serial Number, Tiller-			6 HP Tecumseh	(4)	42-43
To Locate		2	(7)	107
To Record		2	7HP Kohler	(7)	110
Service Schedules (see Maintenance)			Lubricating	(7)	106
Shaft-			Tiller Controls	(2)	28-36
Drive (see Drive Shaft, Transmission)			Tiller & Engine Maintenance	(7)	92-122
Power Take-Off (PTO)	(8)	151	Tiller Housing Cover, Replacing	(8)	131
Tiller	(8)	127-130	Tiller Jumps Out of Gear	(9)	166#1, 167#2
Wheel	(8)	123	Tiller Shaft, Replacing Oil Seal	(8)	127-130
Shift Lever (see Wheel Speed Shift Lever)			Tiller Troubleshooting	(9)	166-170
Shims	(8)	133	Tilling (see Gardening)		
Shimming Drive Shaft	(8)	133-135	Tines (see Bolo, Cultivating & Pointed Pick)		
Shimming Engine Pulley	(8)	151	Tines-		
Shutoff Clip, 6 HP Tecumseh	(4)	43	Rattle	(9)	169, #15
.....	(7)	119	Untangling	(5)	60
Slopes-			Tine/Wheel Speeds	(5)	62
Tilling Across	(5)	63-64	Tires-		
Tilling Vertically on	(5)	62-63	Bar Tread Tires & Wheels	(5)	74
Snap Rings	(8)	132	(6)	77
Snow Blade (see Dozer/Snow Blade)			4" x 8" Standard Tires & Wheels	(6)	77
Soil, Conditions or Improvement (see Gardening)			Pressures	(6)	77
Solenoid	(7)	117-119	Tire Chains-		
Spark Plug-			Ordering	(6)	80
Description & Function	(4)	45	Traction	(5)	74
Specifications (Gap & Type)	(9)	174-176	Use & Installation	(6)	79-80
Standard Tires & Wheels (see Tires)			Tools, Handy to Have	(9)	173
Starting/Stopping Engine-			Traction	(5)	74
6 HP Tecumseh	(4)	47	Transmission-		
.....	(7)	119	Drive Shaft:		
7 HP Kohler	(4)	52	Adjusting Play in	(8)	133-135
Starting Problems, How to Correct	(7)	119	Replacing Oil Seal	(8)	131-132
.....	(9)	170, #2	Shimming	(8)	133-135
.....		171, #3	Gear Oil (see Oil, Transmission Gear)		
Stopping Tiller	(5)	56-57	Illustration/Description of Parts		12-13

T			Tiller Housing Cover, Replacing	(8)	131
Tecumseh-Lauson Engine (see Engine, 6 HP)			Tire Chains-		
Terracing, How to	(5)	64	Ordering	(6)	80

INDEX

DESCRIPTION	SECTION	PAGE	DESCRIPTION	SECTION	PAGE
Wheel Shaft, Replacing Oil Seal	(8)	124-126			
Troubleshooting Tiller & Engine	(9)	166-173			
Turning Around with the Tiller	(5)	58			

U

Untangling Tines	(5)	60
Uphill Tilling	(5)	65

V

Vertical Tilling, on Slopes (see Gardening)

W

Warranty, Engine	Inside Back Cover	
Wheels-		
Bar Tread Tires & Wheels	(5)	74
	(6)	77
4" x 8" Standard Tires & Wheels	(6)	77
Removing & Replacing, All Types	(8)	123
Wheel Shaft, Replacing Oil Seal	(8)	124-126
Wheel Speed Shift Lever	(2)	30, 34
Wheel/Tine Speeds	(5)	62
	(9)	174

X | Y | Z

IF YOU HAVE TO ORDER A PART FOR YOUR TILLER...

If you need to order a tiller part, please use the part number found in the Master Parts Catalog (which was also inside the plastic envelope with this OWNER'S MANUAL—see "A" in the photo below). When you've located the part number you want, use the PARTS PRICE LIST and ORDER FORM. The price list will tell what the part costs and will give a one or two word description of the part. For example, part #1072 reverse disc is all you need to say, if that is what you want.

Please use the PARTS ORDER FORM (tear that page off) to order parts. Simply fill the form out, enclose it (along with your payment) in the convenient envelope provided, and drop it in the mailbox. Upon receipt, we'll process your order just as quickly as possible.

Also, please understand that we will ship your parts orders to you C.O.D. if the money you send us is not enough to cover all costs. You'll note on the back of the PARTS PRICE LIST and ORDER FORM that we pay C.O.D. fees, ordinary postage or United Parcel delivery costs. We don't pay the freight costs for extra heavy items that are shipped to you such as an engine, a transmission or a Dozer Blade.

We've summarized all of the above details in parts ordering so that you will know what to expect when you do order parts from the factory. If you need engine parts check with your local Authorized Engine Service dealer. If you need help let us know.



OWNER'S MANUAL

for the Troy-Bilt Roto Tiller-Power Composter • Horse Model

INTRODUCTION

Welcome to "power gardening the Troy-Bilt Way." The Troy-Bilt Roto Tiller-Power Composter which you have purchased is not just another piece of machinery. It is a useful, productive machine and a reliable gardening tool that will last for many generations with proper care.

Your Troy-Bilt Tiller was designed to easily chop up, shred and bury the usual vegetation in its path through the garden as well as cultivate and help in other earth moving and snow removal chores. The Troy-Bilt's design, with powered wheels in front and separately geared Bolo tines in the rear, gives it an outstanding combination of tilling and shredding capability that allows the gardener to enrich his soil far beyond his own abilities to do so by hand. The soil enrichment is gained by tilling-in and burying in the soil all manner of organic material that is available. By this method, the Troy-Bilt owner will soon experience better yields than ever before. This is said to be the greatest single benefit of power gardening, "the different, better and so much more enjoyable Troy-Bilt way."

Your Troy-Bilt Tiller was designed and manufactured to provide you with a highly versatile gardening tool which will last virtually a life time. Since we provide a Limited Warranty with our no time limit promise, we have to build your Troy-Bilt as strong and trouble-free as we know how. Of course, this is to our mutual benefit. We have fewer service problems and you have a truly reliable tiller.

RUGGED TILLER DESIGN

Your Troy-Bilt Tiller has a rugged gear driven transmission that runs continuously in a bath of gear oil, has steel worms which mesh with forged bronze worm gears, and roller bearings on the drive shaft and tiller shaft. The tiller's

engine has a cast iron cylinder block and crankcase. The crankshaft is supported either by the long bearing surface of durable bronze bushings, or ball bearings. With a matched set of belts, the engine delivers maximum power through the tiller transmission to the wheels and tines. The power driven wheels of your tiller not only propel the machine, but also serve to hold the tiller back long enough for the tines to do their digging completely and effectively. This allows all of the power of the gear driven tines to be used for digging only.

You can insure long lasting and proper performance from your tiller and engine far beyond the anticipation that most people have, by always remembering to do the following:

1. Use the proper motor oil for the engine.
2. Use the proper gear oil for the tiller's transmission.
3. Use a clean, fresh regular grade of gasoline for the engine.
4. Check oil level of the engine every day before using and check gear oil for the tiller, as prescribed in this manual on page 19. Check the motor oil more frequently if the tiller is used for periods extending for more than two hours without let up. During extended work, check for dirt in engine oil, or in the air cleaner. Do the same in dusty conditions.
5. Clean, oil and adjust linkages of external parts of your tiller periodically—see Section 7, pages 92 and 93. Keep nuts and bolts tight.

By treating your tiller and the engine with good care in the manner prescribed above, your efforts will be returned many times over in the form of a more satisfying and easier operating machine, and much more bountiful gardening results.

IMPORTANT

• Before trying to run your Troy-Bilt Tiller for the first time, please make sure that you have taken the following steps:

1. Studied photographs locating controls and compared the photos with the actual controls on your tiller.

2. Have added 90 or 140 weight gear oil to the tiller transmission and #30 oil rated SE to the engine oil reservoir.

3. Have familiarized yourself with all of the engine controls.

4. Have worked the tiller controls without engine running and understand what each does.

5. Have read the Safety Precautions in Section 3.

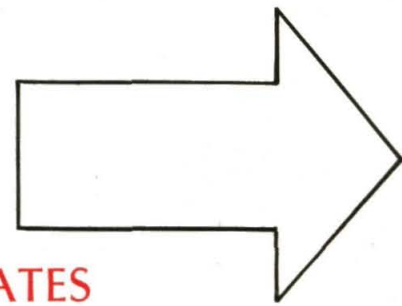

ENTIRE GEAR TRANSMISSION ROTATES CONTINUOUSLY IN A BATH OF GEAR OIL

1. Steel wheel shaft.
2. Bronze bushings support wheel shaft.
3. Heavy duty spur gears provide final reduction to wheels.
4. Shaft for pinion gears is mounted on ball bearings.
5. Heavy duty steel pinion gear cluster rigidly assembled with forged bronze worm gear. Together they provide a reduction of high and low speeds for wheels.
6. Bronze worm gears are forged to make them more durable.
7. Heavy duty cast iron transmission and tiller housings are extra strong. Heavy weight of transmission is better for tilling traction.
8. Steel main drive shaft.
9. Automotive-type tapered roller bearings can withstand the heaviest loads in several directions. They are used on main drive shaft and tiller shaft which have such loads.
10. Steel worms drive the bronze worm gears of the wheel and tiller shafts.
11. Cast iron sliding clutch engages proper spur gear for selected wheel speed and turns wheel shaft.
12. Steel tiller shaft is tapered on the ends for better holding power and for easier installation and removal of tine holders.

**HERE IS A LOOK INSIDE THE
TRANSMISSION CASE AND
TILLER HOUSING OF YOUR
TROY-BILT ROTO TILLER-POWER
COMPOSTER**

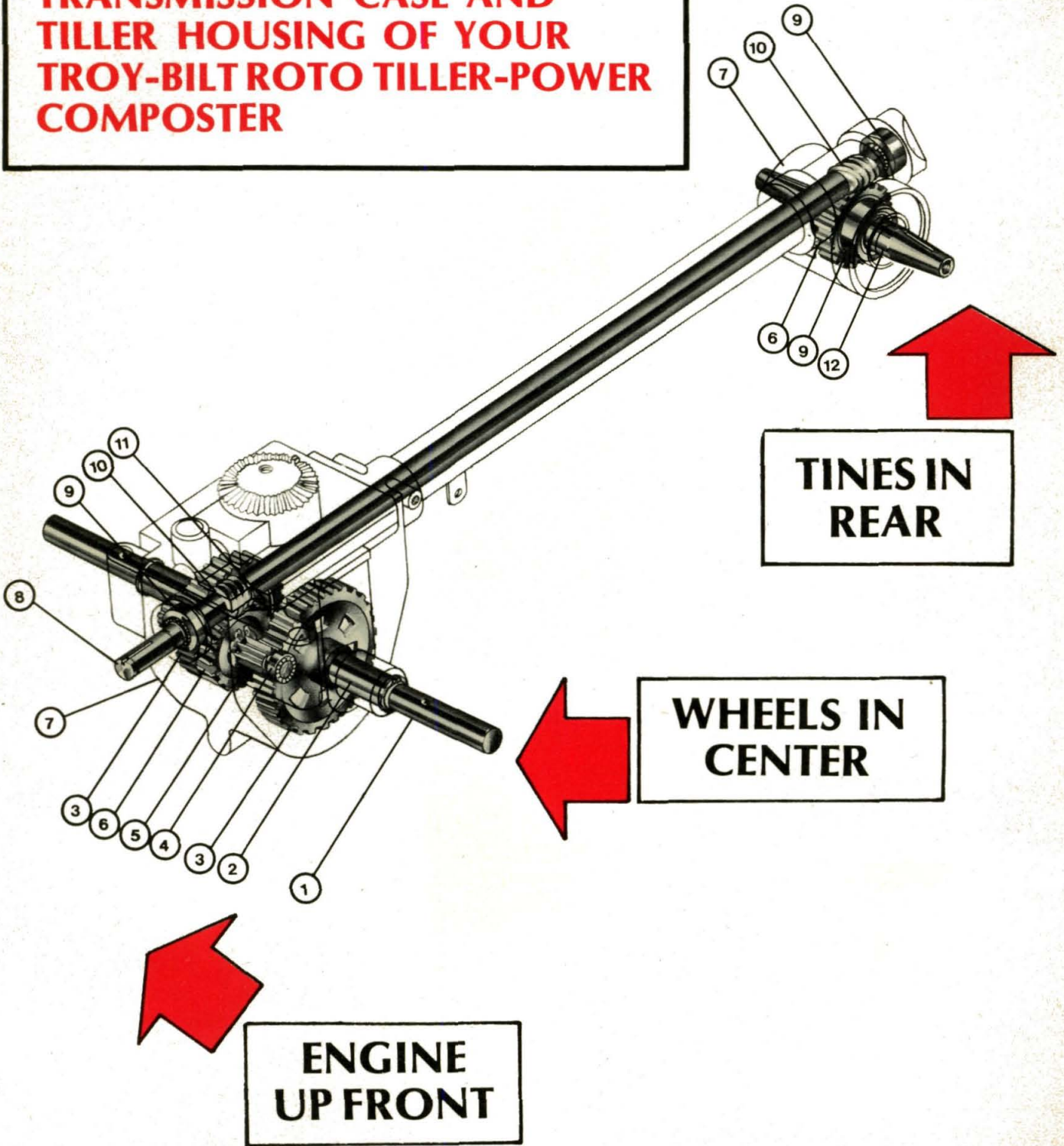

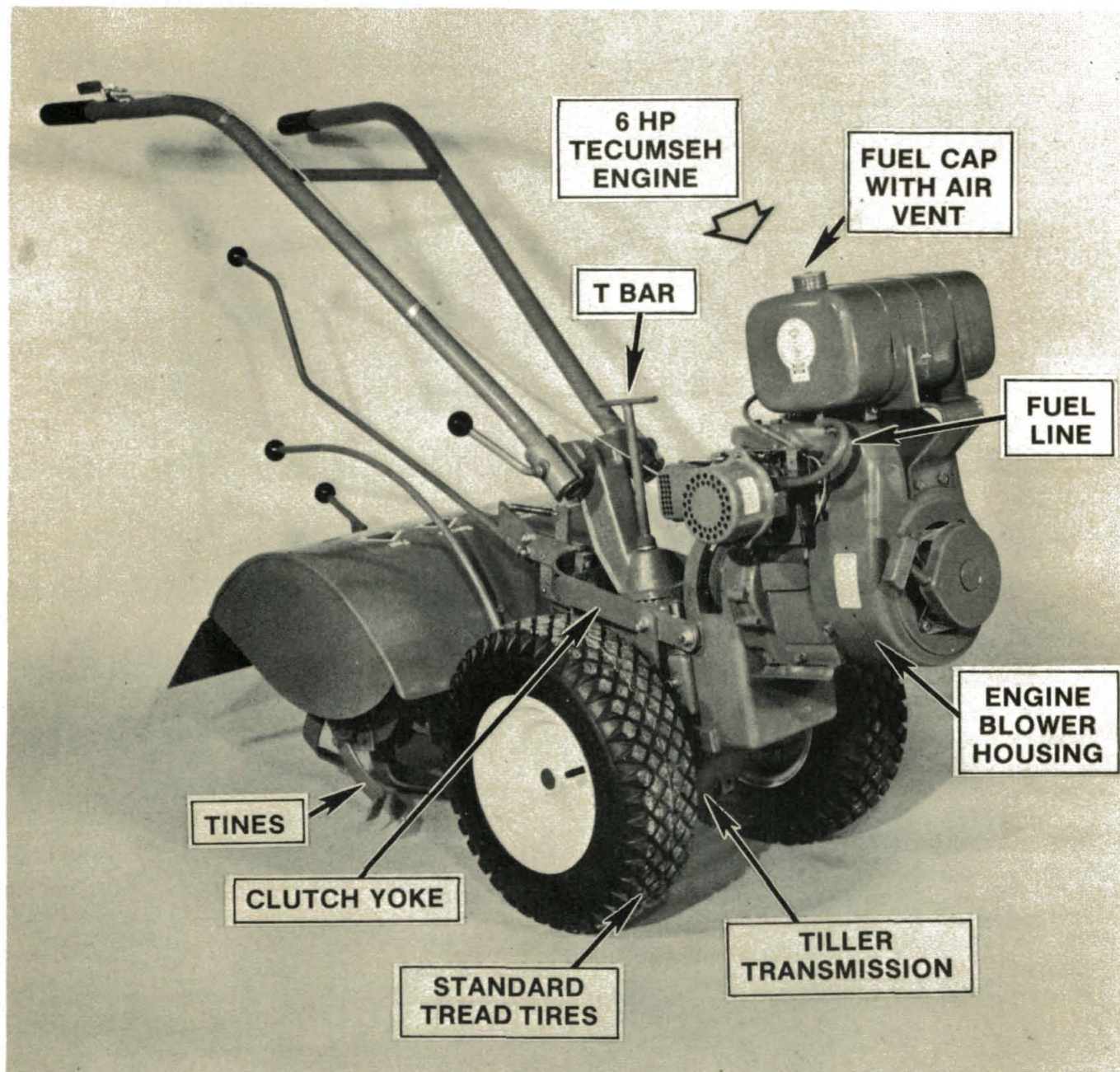

HERE IS A TROY-BILT HORSE MODEL TILLER showing location of some parts and assemblies of it that you'll need to know.

CAUTION: Your Troy-Bilt® Roto Tiller-Power Composter has been designed with many safety features to protect individuals from harm. However, it is necessary for the operator to follow operating instructions and safety practices closely at all times. Failure to do so could result in injury or property damage. See Safety Precautions, Pages 37 & 38.

ATTENTION PLEASE • Your Troy-Bilt Roto Tiller-Power Composter is a basically simple machine to operate and to handle, but there are certain things that you should know before operating your tiller, and certain precautions that should be followed. For this reason, there are portions of this manual that should be read and understood before attempting to run the tiller. These portions are easily identified by the pages with section numbers in red squares.

1

Here's All You Need To Know About

EASY ASSEMBLY

Of Your New TROY-BILT®

HORSE MODEL ROTO TILLER-POWER COMPOSTER

WE RECOMMEND—That you follow this simple six step check-off list for quick, complete and easy Tiller assembly. Please note the gear oil and motor oil required are shipped to you in the tiller's container.

- STEP 1** **Removing Tiller And Attachments From Shipping Container**
- STEP 2** **Adding Gear Oil To Transmission**
- STEP 3** **Adding Motor Oil To Engine**
- STEP 4** **Attaching Forward/Reverse Lever**
- STEP 5** **Attaching The Handlebars**
- STEP 6** **Attaching The Throttle Cable**

STEP 1 □ REMOVING FROM SHIPPING CONTAINER

1

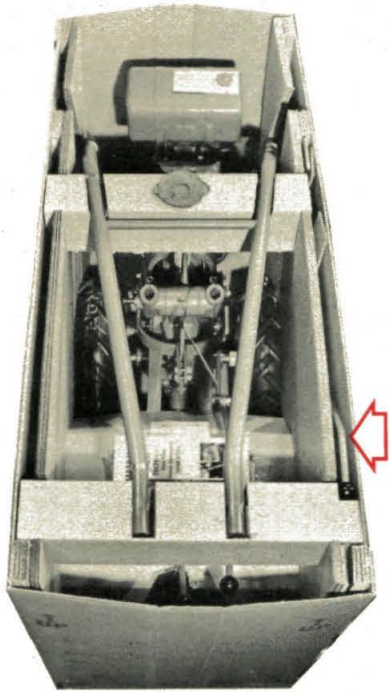

A. (Photo 1/1) Remove the handlebars and put them gently aside. Next, remove the Forward/Reverse Lever and its spring taped on. Lever is tucked between the walls of the container (see arrow in photo), or lever is in plain view at top.

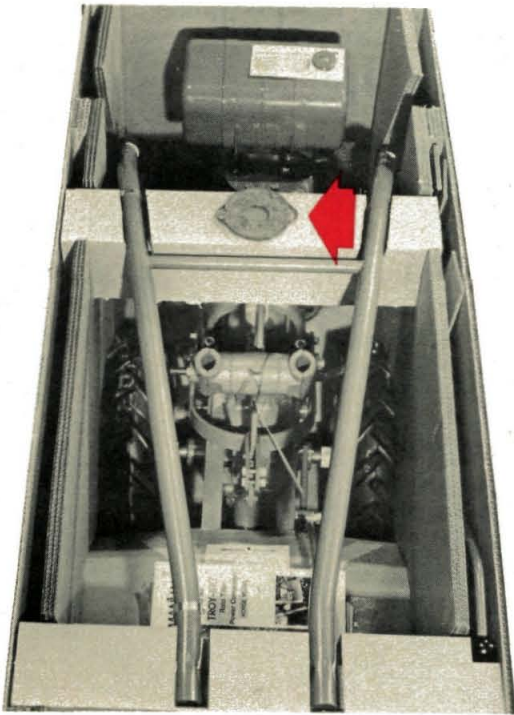

B. (Photo 1/2) **For 6 HP Tecumseh-Lauson Engines Only**—Locate and remove the air cleaner for your engine (see arrow in photo) which is protected during shipment by the fiberboard cross-piece. Set the air cleaner aside, for now.



C. (Photo 1/3) Now, lift off the sides of the container from the base. **NOTE:** If you also purchased a furrower or a set of pick tines, they would ordinarily be included in the container. Be sure to remove the motor oil and gear oil before lifting off sides.

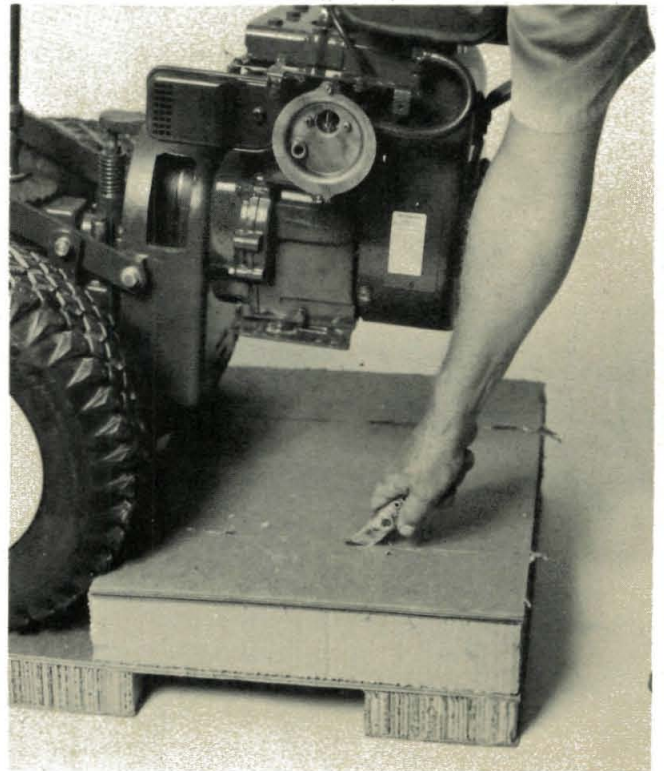

D. (Photo 1/3A) Using a knife or similar cutting tool, make two cuts through the carton from a point in front of the inside of each wheel to the edge of the fiberboard base, as shown.

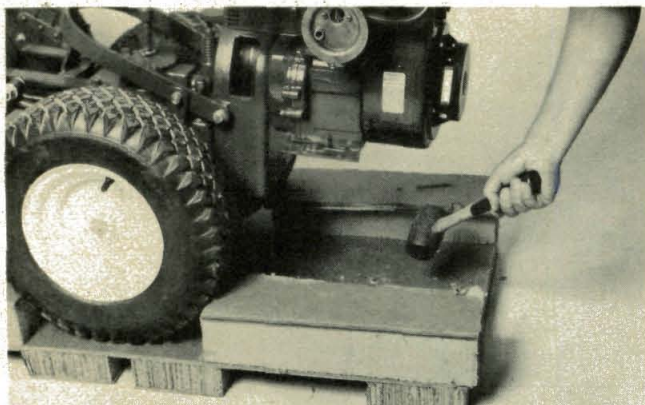

E. (Photo 1/3B) Once the top fiberboard is cut and removed, you can hit the remaining portions off with a mallet, as shown.



F. (Photo 1/3C) Grasp the Depth Regulator handle (the lowest lever in rear, center) and lift and roll the tiller off the container base. If the wheels won't turn, move the Wheel Speed Select Lever (on the right) a short distance to free the wheels.

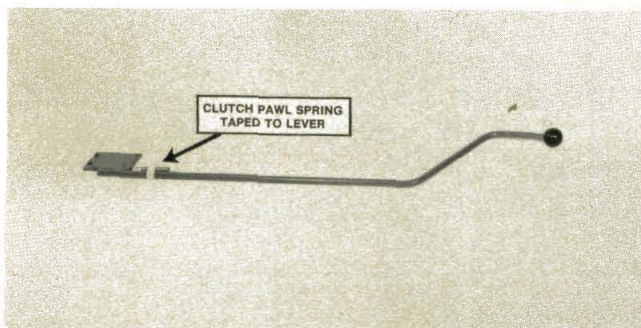

G. (Photo 1/4) The Forward/Reverse Lever and its clutch pawl spring are shown above removed from the shipping container. The lever may be tucked between the inner and outer walls of the container—shown by arrow in Photo 1/1.

H. For 6 HP Tecumseh Engines Only—To install the sponge air cleaner on your engine: (1) loosen screws (2) place cover over air cleaner base (see Photo 1/5) and turn cover clockwise so that screws move into narrow slots (3) tighten screws to prevent air leaks between the two parts—see Photo 1/5A.

1

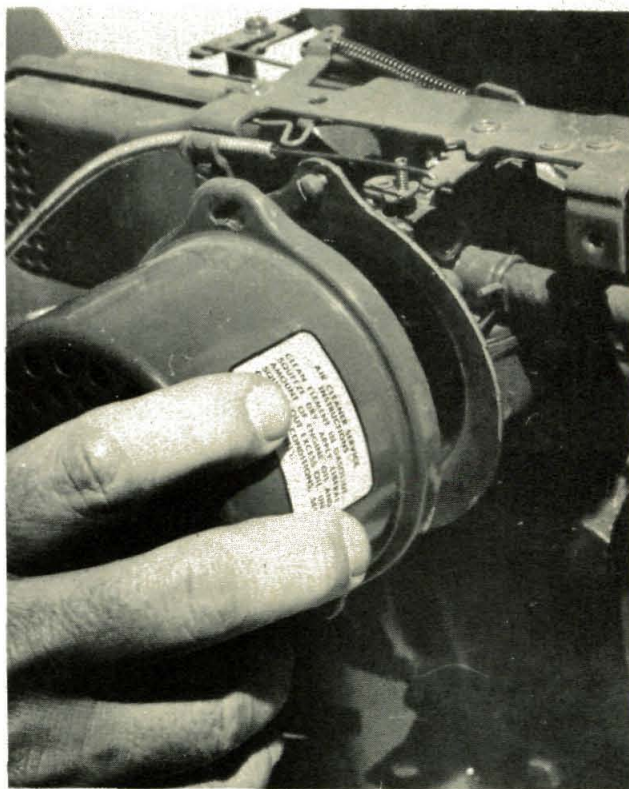

(Photo 1/5) Install air cleaner on base.

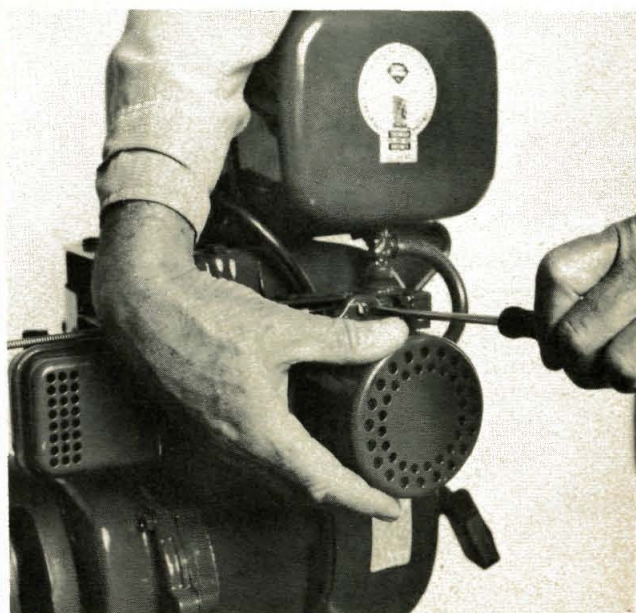

(Photo 1/5A) Tighten air cleaner screws.



I. (Photo 1/6) Remove the wire holding the yoke. This will free up the yoke.

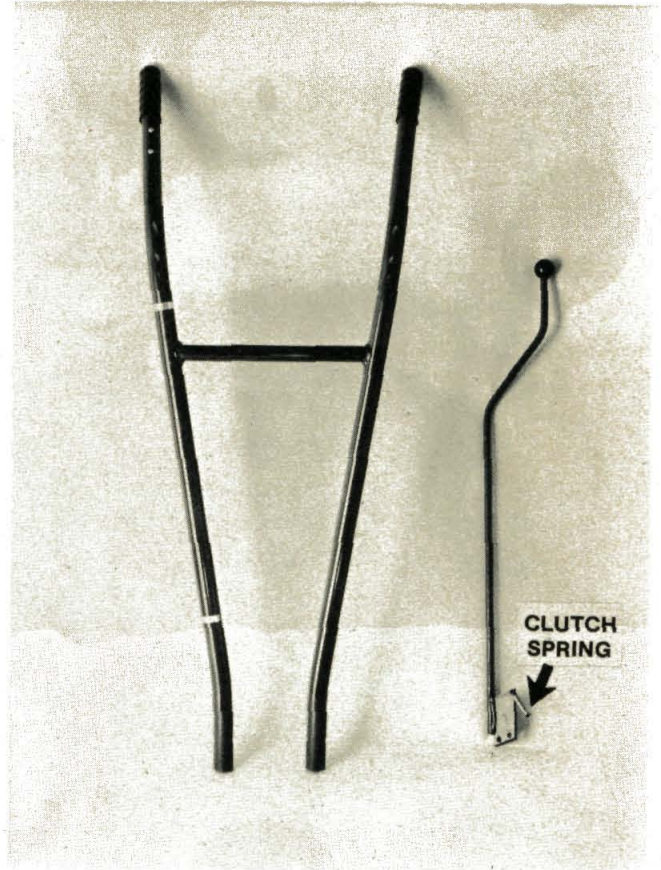

J. (Photo 1/6A) As the last part of Step 1, look to make sure that everything is removed from the shipping container. Have you removed the handlebars, Forward/Reverse Lever, and its clutch spring (taped to rod)?

FREIGHT DAMAGE OR MISSING PARTS

IF YOU NOTICE ANY DAMAGE—either at the time of delivery, or later during the assembly process: Within 15 days of delivery, or if possible much sooner, you should notify the freight company in writing of your intention to file a claim. Tell the driver or phone the terminal, but make sure you state your intention to file a claim in writing. They will advise you how to proceed from there so you'll get complete satisfaction with any claim you may have. But, if you have any problem with this procedure,

please let us know so we can lend a hand. You'll also find complete information on exactly what to do in case of damage among the information that was mailed to you earlier with the letter confirming your order.

IF YOU THINK SOMETHING IS MISSING—notify the freight company just the same as above. But, if you have any questions about anything that we can be helpful with, please call or write to us here at the factory.

EXPLANATION OF "RIGHT HAND" & "LEFT HAND"

Right Hand or Left Hand are determined by standing in the operator position and facing the direction of forward travel.



(Photo 1/7A) Remove T-bar to fill gear oil.

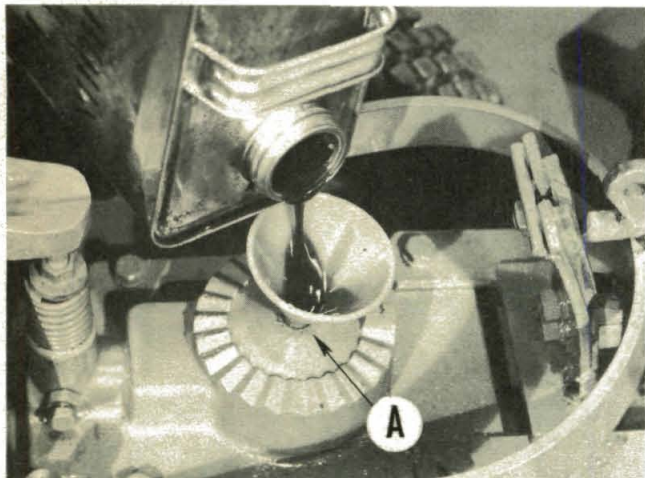

(Photo 1/7) Remove the T-bar and pour gear oil into transmission through hole at (A) handlebar base. It will take about 6½ pints (that's 3 quarts plus ½ pint). See photo. Use a funnel with a ½" tip to assist you.

STEP 2 □

ADD GEAR OIL TO THE TRANSMISSION

Before using the tiller, the tiller transmission case must be filled with 6½ pints of SAE 140 weight or SAE 90 gear oil. By removing the "T" bar and adding oil through the hole on top of the handlebar base, lubrication is provided for both the wheel drive mechanism and the tiller shaft. Oil flows down the tube from the wheels to the tiller.

GEAR OIL IS PROVIDED—All of the gear oil you'll need, plus extra, is included in the shipping container.

If you are tilling (unless it's below freezing temperatures outside), the gear oil does not need to be changed for different air tempera-

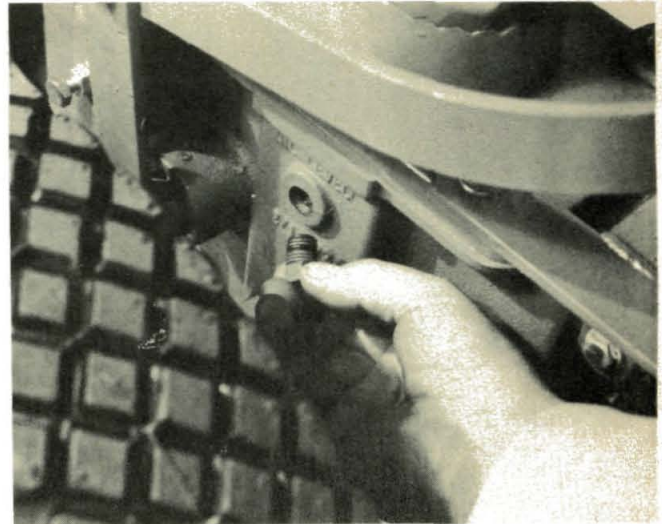

(Photo 1/8) Stop pouring gear oil when it gets to this level. (The oil plug can be found 3 inches above the left wheel.)

tures or climates. In fact, you don't need to change it at all, unless you note that it has picked up a lot of gritty sand or soil. However, if you use the Dozer/Snow Blade for snow removal, it is best to use the 90 weight gear oil when air temperatures get below freezing.

While putting gear oil in the transmission case, make sure that you have the depth regulator pulled up so the tines rest on the floor. This will allow oil to flow back to the tines. Remove the oil plug shown in Photo 1/8, and fill the case until gear oil begins to flow out of the gear oil level hole. **DON'T OVERFILL.** Stop when the oil flows out—even if you haven't added 6½ pints yet. Use a 3/8" wrench on oil plug.

If you have difficulty finding gear oil at a well stocked automotive service station or supply store, take a clean gallon container to a farm supply store, or a tractor, truck or heavy equipment sales and service garage. You'll likely find some there in drums. They'll sell you the 6½ pints required in your glass, plastic or metal container. Just make sure that the container is clean! Use either 90 or 140 weight, whichever you prefer or find easiest to obtain.

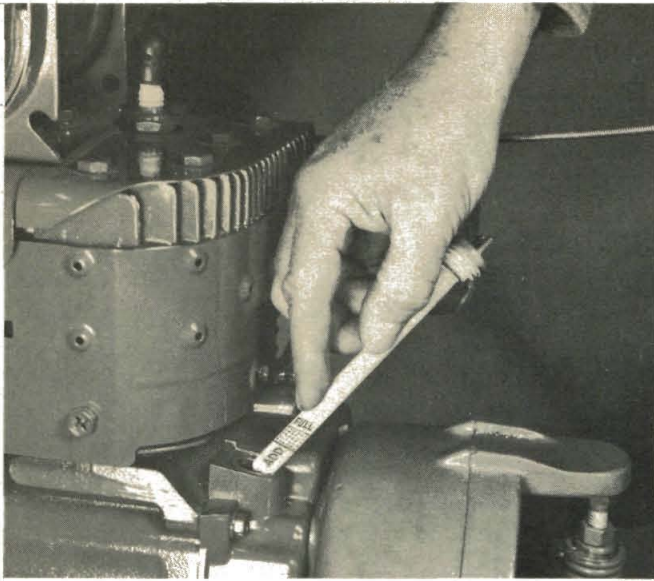

(Photo 1/9) The engine on every Troy-Bilt is equipped with a calibrated dipstick.

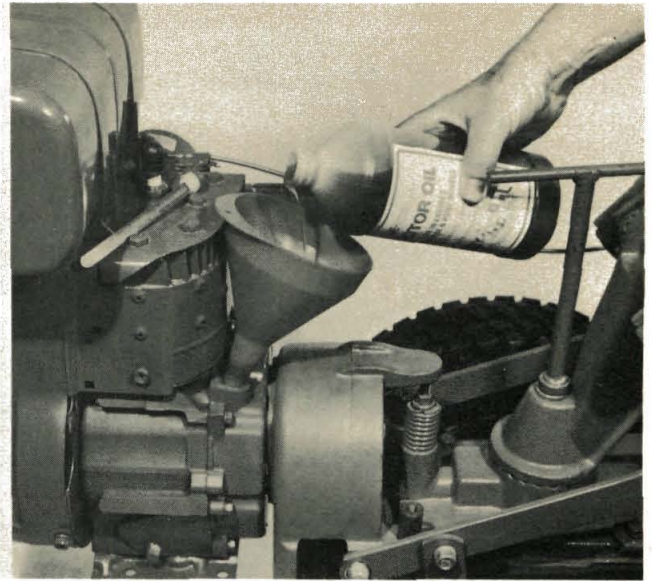

(Photo 1/10) It's a good idea to use a funnel when pouring oil into engine.

STEP 3 □

ADDING MOTOR OIL TO THE ENGINE

Your tiller's engine has different lubrication requirements than the transmission, as described in the previous step. Each engine on a Horse Model Troy-Bilt has a dipstick marked with "Full" and "Add Oil" levels. Please consult the following paragraphs for specific instructions about oil for each make engine.

Use a funnel, as shown in Photo 1/10, to pour a good quality #30, SE classification motor oil into the oil filler hole of the engine—that is the hole from which the dipstick was removed.

Use #30 weight SE rated motor oil in the warm summer weather when tilling. If #30 is not available, 10W-30, or 10W-40 motor oil is acceptable, but make sure you find SE on the top of the can, or on the label. For colder temperatures, consult your engine pamphlet which you received with the tiller.

Any service station of a national petroleum company should have SE classification oil for your engine. Look for SE on the top of the can or on the label. Each engine uses different oil capacities, so please see their instructions and use the dipstick as your guide.

SE classified oil protects your engine best against high operating temperatures. SE oil does have detergents and other additives in it for protection of your engine. So, don't use non-detergent oil!

- *It is important to note that the engine and the tiller transmission take different types of oil. So, please don't put the wrong kind of oil in the engine or transmission.*

6 HP TECUMSEH-LAUSON ENGINE

If yours is a new 6 horsepower tiller, please follow the oil level measuring instructions below. Use #30, SE oil. Owners of used or older Troy-Bilt Tillers should use their dipsticks to determine the proper oil level.

TO ADD MOTOR OIL—Move the depth regulator bar down to engage the first notch (with the tines just off the floor), remember to have the tiller on level ground or a level floor. With the depth adjustment bar in the first notch, your 6 horse power engine will be sitting at its normal slope. In this manner, remove the oil dipstick from the engine (unscrew it). Using a funnel, pour the oil into the dipstick hole until the oil level reading reaches the "Full" mark on the dipstick with the dipstick screwed all the way into the hole. It should take about 24½ ounces of oil (SE #30).

7 HP KOHLER ENGINE

TO ADD MOTOR OIL—With a *new* engine, use 2½ pints of #30 weight motor oil which has a service classification of SE. With a wrench, remove the dipstick and fill the oil up to the dipstick's "Full" mark. To measure, put the dipstick in hole while engine base is level and rest threads on top of hole (do not turn threads in). See Photo 4/26. Put a small board under the tines or the tiller's drag bar to level out the engine base.

STEP 4 □

ATTACH FORWARD/REVERSE LEVER

The next step is to take the Forward/Reverse Lever and connect the lever to the yoke assembly.

Remove the two bolts in the end of the yoke and insert the plate on the end of the lever in between the two parallel pieces of the yoke—as shown in Photo 1/11. Loosely install one of the bolts as shown—with the plate over the lever not under the lever—and attach the spring at both ends. The spring goes in the two pin holes—one in the roller assembly linkage and one in the plate of the lever. Then, pull the lever down to align the holes and install the second bolt, lockwasher and nut.

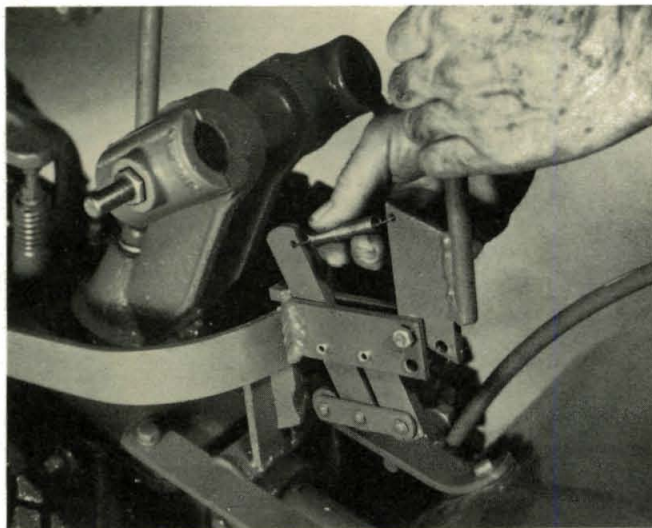

(Photo 1/11) Connect both ends of the clutch spring this easy way.

Please use two ½" wrenches to tighten the nuts enough to flatten the lock washers, and securely fasten the lever to the yoke. The lever

should be tight enough so it won't wobble to the left and right. Don't overtighten and break the washer.

STEP 5 □

ATTACH THE HANDLEBARS

Even your handlebars can be assembled without the use of any wrenches; the following techniques will simplify the task and avoid scratching the paint. Please refer to **C** in Photo 1/12. Remove the vertical adjustment stud (part #1150) from the handlebar base and the two ratchets (part #1020-1 and #1020-2).

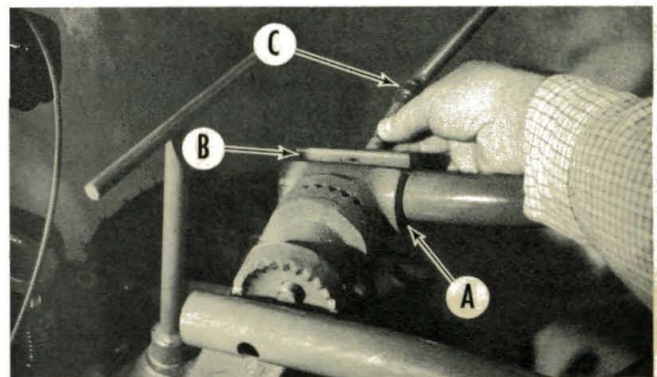

(Photo 1/12) Start with right side ratchet A, clamp B, and stud C, like this.

Lay the handlebars on top of the tiller so that the crossbar rests on the Forward/Reverse Lever that you just installed. Next, put the clamp B on the adjustment stud C. Pass the stud through the right handlebar and also put the right hand ratchet A on the stud (between the handlebar and the cast iron mounting base). Then, push the stud through the base as shown in Photos 1/12 and 1/13.

The next step is to get the left inside ratchet in between the other handlebar and the handlebar base. After that, all that remains is to push the handlebar adjustment stud all the way through, then wind it up against the nut on the left outside clamp, as in Photo 1/14. Set your handlebars at a comfortable operating height. Please remember, they will be 3 to 4 inches lower during tilling than now—while the tiller is setting on a solid surface.

When tilling, if you can't find a handlebar height position that is "just right" for you, height adjustments "in between" your present adjustments can be obtained by switching the left and right inside ratchets (right ratchet is shown as **A** in Photo 1/12).

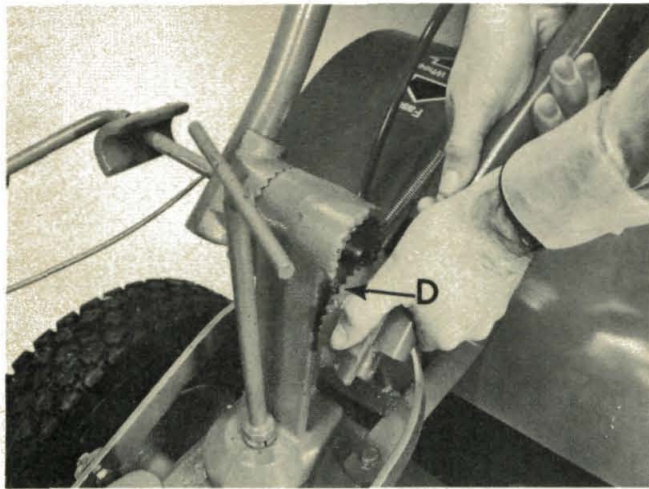

(Photo 1/13) Now force the handlebars apart and install the left inside ratchet, **D**.

STEP 6 □

ATTACH THE THROTTLE CABLE

At the factory, throttle cables have been attached to the engine and checked for proper carburetor controls operation. The cables are wrapped around the engine and merely have to be uncoiled and attached to the top of the handlebar with the two screws—as shown in Photo 1/15. All engines used on Troy-Bilt Tillers come with cables attached in this manner.

Please be careful not to kink the wire when you uncoil it or are attaching it to the tiller handlebar with the two clips already in place on the right handlebar. Pry one clip off the handlebar, lay the throttle cable underneath the small raised portion of the clip and push the clip back into place on the handlebar, as shown in Photo 1/16. Repeat the process with the next clip.

Some people prefer to take a screwdriver and turn the screw (shown as **A** in Photo 1/17) three-quarters of a turn into the threaded hole. This action will bend the copper clad wire, forming a small loop. Just take the end of the screwdriver and push the end inward out of the way of fingers and hands so you won't get scratched by it. This procedure will give you added assurance that the throttle wire won't come out of the set screw—although, if properly

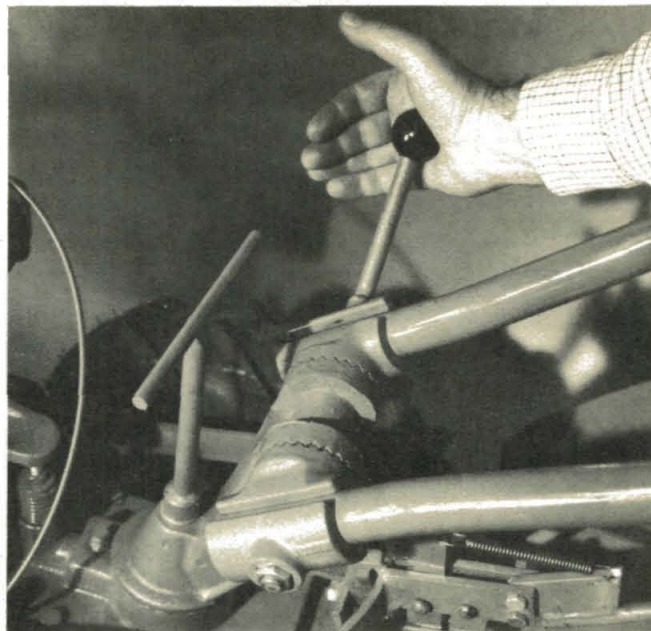

(Photo 1/14) Set handlebars and wind adjustment stud in tight.

secured, it should hold the wire. If an adjustment is needed to get full choke or engine shut-off, refer to page 108, Photo 7/42.

With 6 HP recoil start engine, run the cable down the handlebar and over to the engine (Photo 1/18).

On 6 HP electric start tillers, make sure that the throttle cable does not touch any part of the battery or its mount. **DO NOT RUN throttle cable across top of battery.** It could short out battery, causing it damage, and melt the throttle cable. See Photo 1/19.

With 7 HP engines, continue the throttle cable down the right handlebar and across over to the throttle bracket on the engine's governor control disc. See Photo 1/20 and note that the throttle cable must dip down between the wheel and outside of the yoke.

• **On all throttle cable hookups, no matter which engine, there should be a little slack at the bottom of the handlebar** to allow for turning the handlebars to either side without putting stress on the throttle cable at the engine connection.

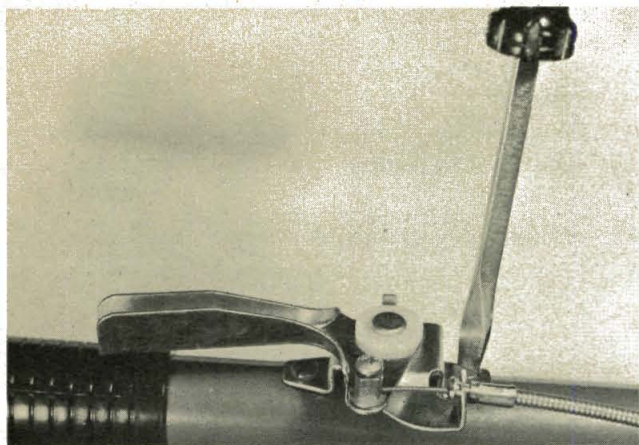

(Photo 1/15) Attaching the throttle control lever.

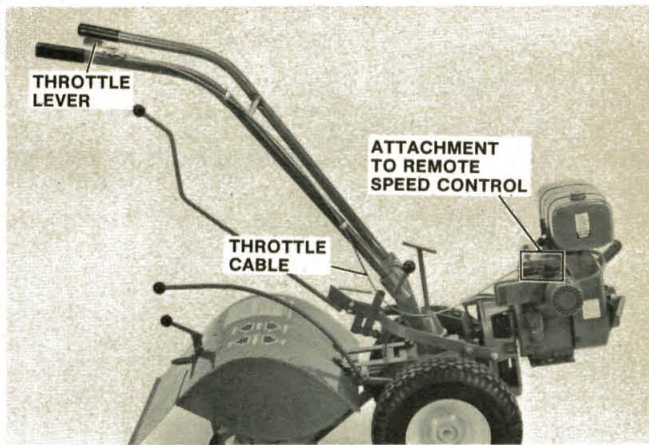

(Photo 1/18) Throttle cable for 6 HP engine runs down the handlebar and crosses over to the engine.

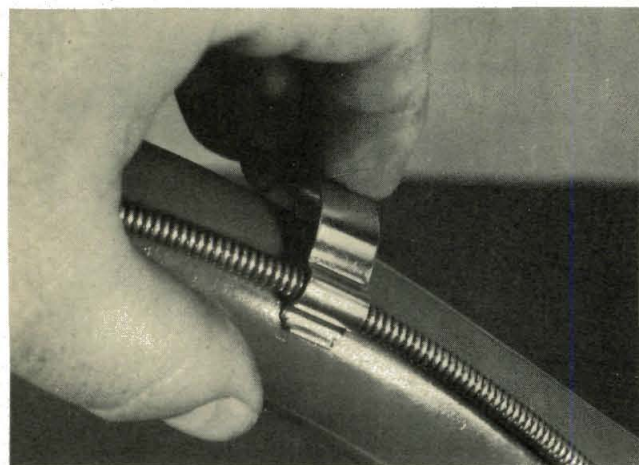

(Photo 1/16) Throttle cable is held in place with two spring clips.

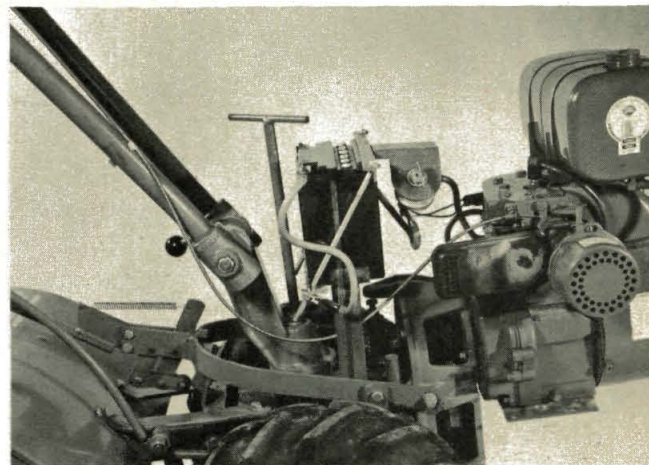

(Photo 1/19) *Keep the throttle cable away from battery and behind the right leg of the battery bracket.*

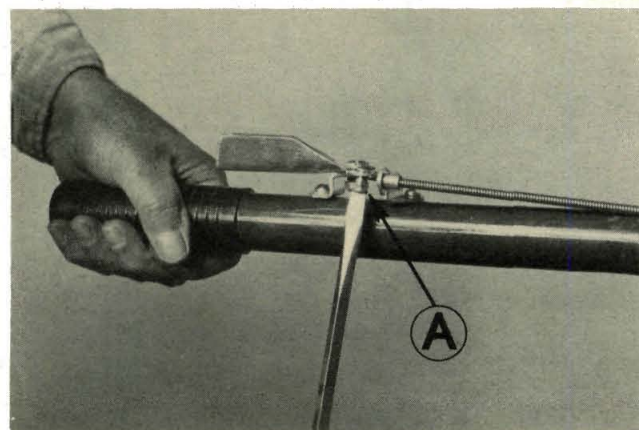

(Photo 1/17) Turning screw loops wire

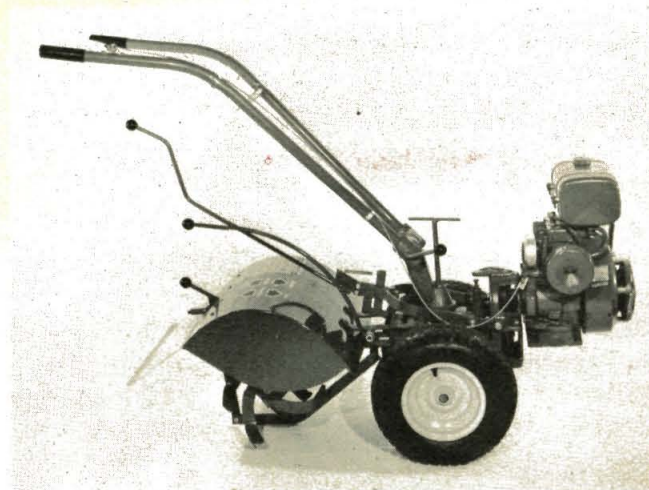

(Photo 1/20) 7 HP engine with throttle cable running outside of the yoke.

PREPARATION & OPERATION OF THE 6 HP TECUMSEH ELECTRIC START ENGINE

1

After completing the steps of Easy Assembly you are ready to prepare the electric start system for operation. But first, please read through all of these instructions. Before preparing the battery, be sure to read the safety precautions about battery acid on page 38, Section 3.

WARNING—Don't smoke, bring flame, or cause electrical sparks near the battery. It contains explosive gases.

Please do not put water in your battery during these preparation steps. You must add battery grade acid to the battery to make it function. The warning about acid below, (and on your battery) is required to warn people about the battery's use after you have added the acid to it.

POISON/DANGER CAUSES SEVERE BURNS

Your battery contains sulfuric acid—avoid contact with skin, eyes or clothing. Antidote: EXTERNAL Flush immediately with lots of water. **INTERNAL**—Drink large quantities of water or milk. Follow with milk of magnesia, beaten egg or vegetable oil. Call physician immediately. **Eyes**—Flush with water for 15 minutes and get prompt medical attention.

Batteries produce explosive gases. Keep sparks, flame, cigarettes away. Ventilate when charging or using in enclosed space. Always shield eyes when working near batteries. KEEP OUT OF REACH OF CHILDREN.

HOW TO REMOVE A BATTERY

To Take It to a Service Station for Battery Acid, please read the following instructions before proceeding with work:

1. Disconnect the positive battery cable at the positive battery post on top of the battery (as shown next to the (+) sign in Sketch 1/21).
2. Disconnect the negative battery cable from the lower end of the 9 inch long battery hold-down bolt. Leave negative cable attached to battery post. The negative cable is the ground cable on the right side of battery. Remove bolt and replace washer and nut on the bolt in sequence for safe keeping. (See Sketches 1/21 & 1/22.)

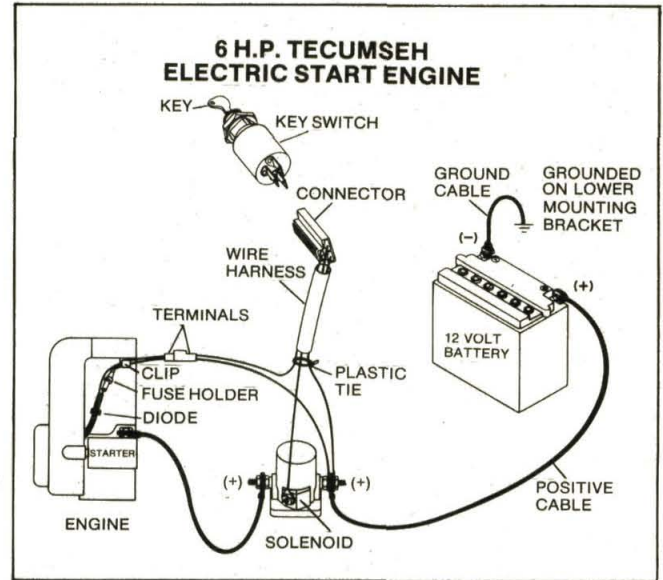

(Sketch 1/21) Small current recharges battery.

3. Loosen other hold-down bolt enough to move battery clamp (bar) away so that battery can be removed easily.
4. Remove the battery and place it on the floor.
5. Take the battery to a service station and have it filled with battery acid with a specific gravity of 1.265 (sulfuric acid).

- If you are going to fill your own battery at home with battery acid (1¾ quarts required), you might wish to remove your battery from the tiller to avoid spilling acid on the tiller.

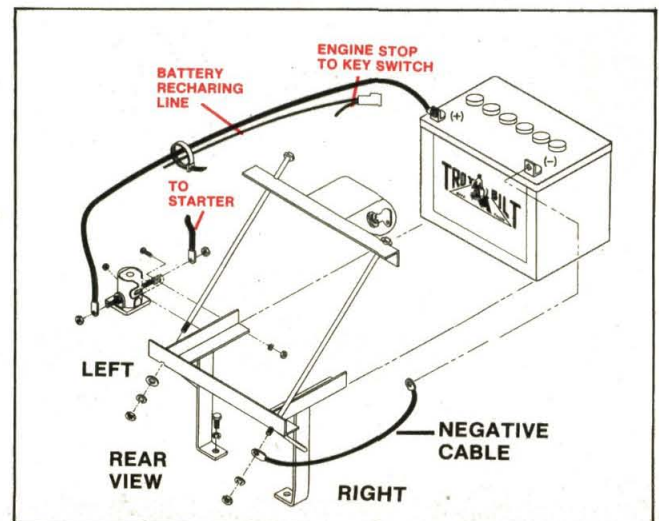

(Sketch 1/22) Battery, bracket, cables & solenoid.

Fill all 6 cells on your 12 volt battery with fresh battery grade acid—sulfuric acid with a specific gravity of 1.265. Fill each cell with battery acid up to the bottom of the acid fill tubes—see Sketch 1/23. Always keep plates covered with acid. Note that the depth regulator of your tiller should be in “travel” position, with the tines off the floor. Wait 20 minutes, recheck the level and add more acid where needed to bring each cell up to the proper level. It will take slightly less than 1¼ quarts (56 ounces).

Don't dilute the acid with distilled water during initial preparation period. **YOU MAY ADD WATER (DISTILLED) LATER ON TO REPLACE WATER THAT HAS “BOILED OFF.”** If acid level is too low or acid is diluted, you won't get full starting power or receive a satisfactory battery recharge. Never add acid to battery after initial filling. It can do more harm than good.

NOTE: Almost any large service station or battery supply store has the battery acid needed, and will charge the battery—if it is necessary.

CAUTION

- If battery is charged or installed in reverse, damage can result to the battery, diode and electrical system.
- Accidental grounding of wires and terminals is the first thing to look for, if you have difficulty. Keep the battery charged at all times. During inactive periods, use your electric start and run the engine for 30 minutes to charge your battery.

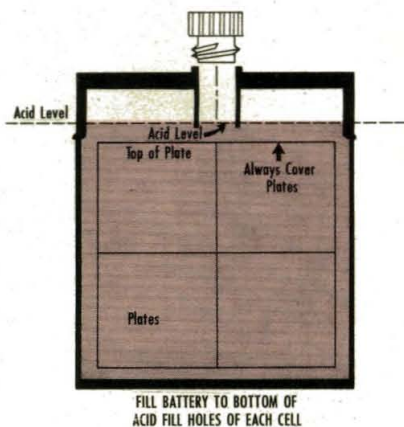

(Sketch 1/23) Always keep plates covered with acid. Fill to bottom of acid filler tube.

HOW TO REPLACE BATTERY

1. Place the battery on the bracket and replace the battery hold-down bolts as described below.

Please make sure that the positive wire goes to the positive battery terminal.

That's why we suggested leaving the positive wire unattached at the top of the battery, and the negative one unattached at the bottom of the battery. If you have done this, you can't make a mistake in reconnecting them.

First, connect the positive cable to the positive battery terminal (marked with a (+) sign on the top). Connect the negative cable last, to avoid short circuits that will damage the battery.

The long bolt on the left uses a plain washer, a lockwasher and nut to secure the clamp. The long bolt on the right uses only a lockwasher and a nut. The right cable connection must be assured proper grounding of the cable through the bracket to the transmission case. Tighten the nuts on both 9 inch bolts until the clamp holds the battery securely in place. **Do not overtighten these clamps. Avoid distorting or cracking the battery case.**

2. When the positive terminal is re-attached to your battery and the negative terminal is attached to the bracket at the bottom of the battery, you're ready to test your battery electric start system.

TESTING OPERATION OF YOUR BATTERY ELECTRIC START SYSTEM

• After you've added battery acid and checked the levels of all cells, make sure that:

- you have read the pages in Section 2, 3, & 4 of this manual identified in red squares.
- there is motor oil in the engine and gear oil in the tiller transmission.
- the tiller Forward/Reverse Lever is in the Neutral position.
- the tiller Wheel Speed Shift Lever is in low gear.
- the throttle lever on the handlebar is put into the engine shutoff position (for safety).

• Now, you're ready to test the electric start system to see if it will work properly later (when you have put gasoline in the fuel tank). You won't need gasoline for this test.

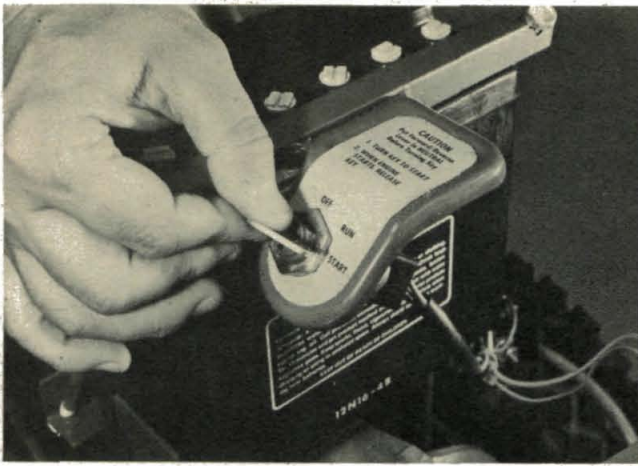

(Photo 1/24) Turn key to start.

Turn the key to the START position as shown in Photo 1/24 and hold it there (no longer than 10 seconds). The starter motor should turn over, indicating that the battery and the electric starting system should work properly. When you hear the starter motor turn over, release the key and it will move to the RUN position. Of course, if you've completed the pages with numbers in red squares and have put gasoline in the fuel tank, the engine will start, if the throttle lever is in low speed and the manual choke is on FULL CHOKE.

- If your engine's starter motor tries to start the engine (or does), you know that your battery is O.K. Check the acid level at least every 10 hours.

STARTER MOTOR WON'T TURN OVER

A. If your starter motor does not do anything, check out all electric start wires to make sure that they are snug and are not touching other metal housings or brackets (at the exposed terminals of each wire).

WIRES O.K., STARTER MOTOR STILL WON'T GO

B. Next, you'll have to charge the battery briefly to see if you can activate it. Make sure the tiller's Forward/Reverse Lever is in Neutral and start the engine up with the recoil starter. Battery cells must be filled properly with acid before running the engine and key must be at RUN. Run it for 45 minutes or more. Stop the engine and see if the starter motor will start the engine when the key is turned to START. If it works, all systems should be in working order now.

ENGINE RUNS, STARTER WON'T ENERGIZE

C. If you run the engine to activate the battery, but the key switch won't start the engine, look at

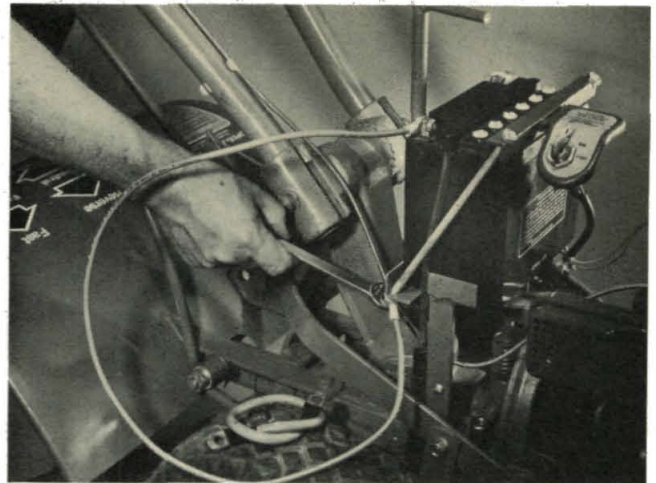

(Photo 1/25) Replace ground cable with wire.

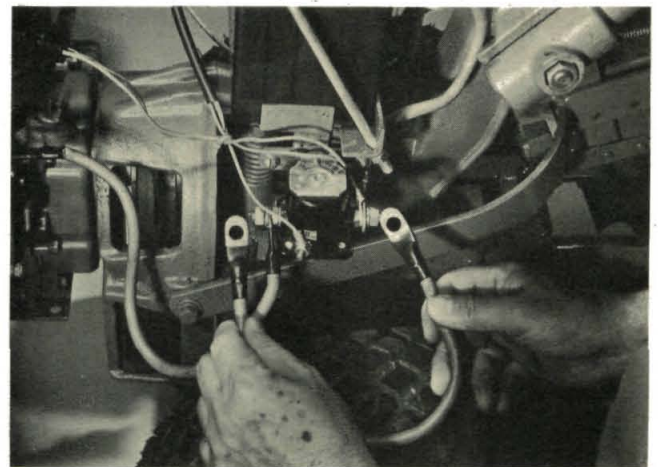

(Photo 1/26) Touch ground cable to right and left posts.

Photos 1/25, 1/26 and 1/27. Get a 12 inch piece of heavy, insulated wire (number 10 wire or heavier). Strip $\frac{3}{4}$ inch of insulation off both ends of the wire. Then, disconnect the negative battery cable—on the right side, where the key is—and replace the cable with the heavy wire as shown in Photo 1/25. Using the battery cable you removed as a "jumper wire", firmly touch one end of the wire to the right post of the solenoid as shown in Photo 1/26 and then momentarily to the left post (shown in photo) where another heavy cable leads over to the starter motor.

The brief touch with the jumper wire will most likely cause a spark and should also energize the starter motor. As a precaution, so the tiller won't start up and move unexpectedly, you should put the Forward/Reverse Lever in Neutral, disconnect the spark plug wire or move the engine's throttle lever all the way forward to the engine shut-off position, for safety.

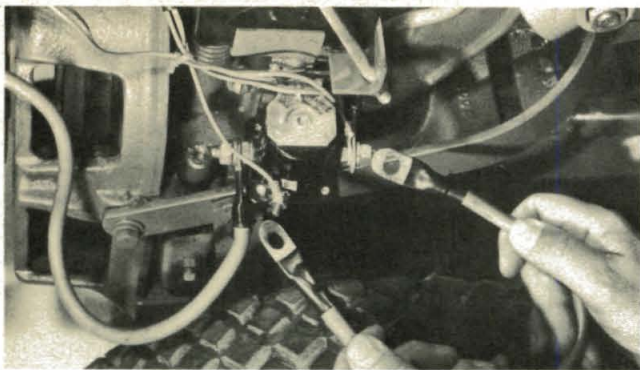

(Photo 1/27) Touch cable to right and center posts.

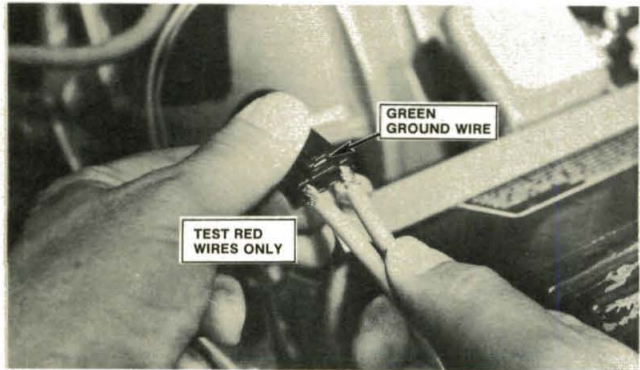

(Photo 1/28) Jump wires to key switch.

If the battery turns over the starter, or starts the engine, it shows that the battery and the starter are O.K. But, it also indicates that you might have a loose connection with the key switch wires, the connectors between the two, or a problem with the key switch itself, or with the solenoid (not very often the solenoid). To find out which it is, go to **D** below.

If the ground wires have been tight and you get no energizing of the starter or any sparks, you'll have to remove the battery and have it tested. Look at "How to Remove Battery," on page 24, and take your battery to a battery store or a good automotive service station and have it tested. If the battery is bad, get in touch with our service department. If you operate your tiller without the battery installed, be sure you disconnect the fuse, as explained in the next column under the heading "In Case of A Dead Battery." Check acid level every 10 hours.

POSITIVE CABLE ENERGIZES STARTER, KEY SWITCH WON'T WORK

D. With a battery that is known to be good, use the negative cable as a "jumper wire" again as described in the preceding test under **C** and firmly touch it to the right post of the solenoid and then the other end momentarily to the center post, as shown in Photo 1/27.

If the starter motor turns over, the test confirms that the solenoid is good (the positive battery cable must be properly connected to do so), but it indicates that there is a problem with the wires to the key switch, the connections to the switch or with the switch itself. Photo 1/28 shows how to test the wires to the key switch. First you must reinstall the negative battery cable, disconnect the terminal from the key switch as shown in Sketch 1/21 and use the test wire to jump the terminals for the key switch wires as shown in Photo 1/28.

If the starter motor turns over when you jump these wires, the wires are good and your connection to the switch might have been loose, or the switch might be bad. To test the switch itself and the wires too, turn to pages 117 and 118 of this manual. If the battery is good and you had no energizing of the starter motor at the start of this test **D**, then the solenoid is bad (if the starter energized in test **C**). If this is so, please get in touch with our service department at the factory for instructions.

IN CASE OF A DEAD BATTERY

• IF YOUR BATTERY IS DEAD, OR ONE OR BOTH BATTERY CABLES IS DISCONNECTED, YOUR RECOIL STARTER CAN BE USED TO RUN THE TILLER, AFTER YOU HAVE TAKEN THE FOLLOWING STEPS TO PROTECT YOUR ELECTRICAL SYSTEM.

1. Make sure that all battery cells are full of battery acid—with no lead plates exposed. If the engine is run with a dry battery (or one low in acid), the battery and other electrical parts can be damaged.
2. IMPORTANT: Disconnect the fuse holder, remove the fuse and tape over the fuse holder's half nearest the engine to protect the diode. See Photo 1/29.

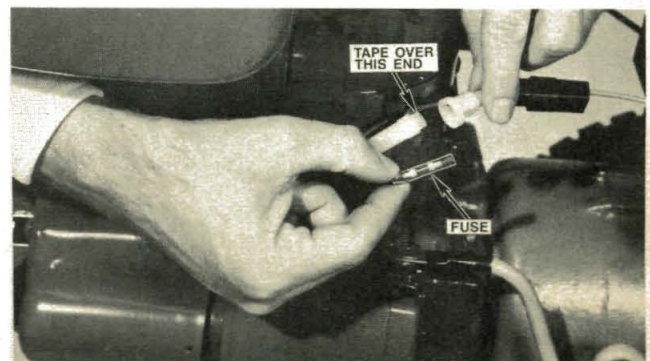

(Photo 1/29) Push and twist fuse holder.

TILLER CONTROLS

2

1 is the Forward/Reverse Lever. 2 is the Wheel Speed Shift Lever. 3 is the Depth Adjustment Bar for the depth regulator. 4 is the Handlebar. The Handlebar adjustment controls, which require no tools to operate, are shown at 5, the Height Adjustment Control, and 6, the "T" bar Horizontal Adjustment Control that adjusts the handlebar to either side of the tiller.

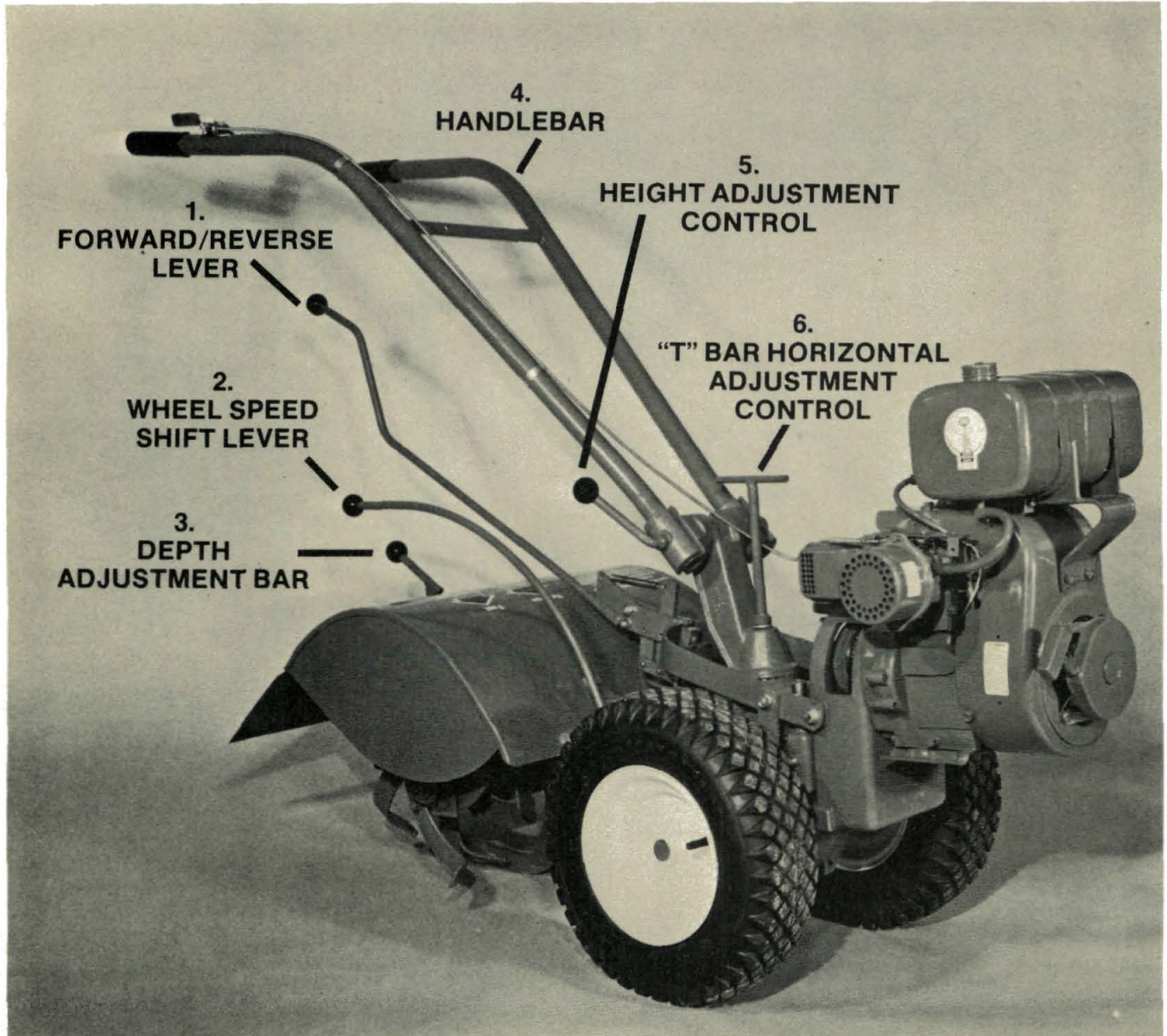

(Photo 2/1)

IMPORTANT

- Please carefully read the information on safety on pages 37 and 38 before operating the tiller or allowing others to operate it.

TILLER CONTROLS

Photo 2/1 shows the location and identification of controls for your tiller. Please study it carefully with the text that follows. Listed directly below are descriptions of what each control does and how each functions to operate

your Troy-Bilt Horse Model Roto Tiller-Power Composter.

On the Troy-Bilt Horse Model Tiller there are two levers at the operating position that control machine motion and one lever that controls tilling depth.

FORWARD/REVERSE LEVER—The highest lever in the center (1 in Photo 2/1) acts as a clutch lever. It provides engine power to both the tines and wheels—however, the wheels also have a separate shift lever described on page 30.

1. To go Forward, simply push the Forward/Reverse Lever (see Photo 2/2) down far enough to engage the roller under the block (shown in Photo 2/3).

2. To go to Neutral from Forward position, tap the lever up to move roller to the indentation of block—see Photo 2/4. Tiller motion will stop.

3. For Reverse motion, lift the lever all the way up and hold in reverse position. See Photo 2/5. You will also be lifting up on the handlebars (see

Photo 2/11) so the tines will be out of the soil. Let go of the lever while it's in Reverse, and tiller motion will stop automatically (a safety feature for the operator). As you can see, the roller doesn't have to move very far from Neutral to Reverse.

In other words, you must *lift up* on this lever in order to operate the tiller in *reverse* direction. **If your tiller moves in reverse without your needing to hold the clutch up in the reverse position, it is badly out of adjustment.** **WARNING:** *This is a dangerous situation. See Section 7, page 102, telling how to remedy this situation.*

IMPORTANT: Always use the Forward/Reverse Lever to stop tiller forward or reverse motion.



(Photo 2/2) Forward/Neutral/Reverse Lever

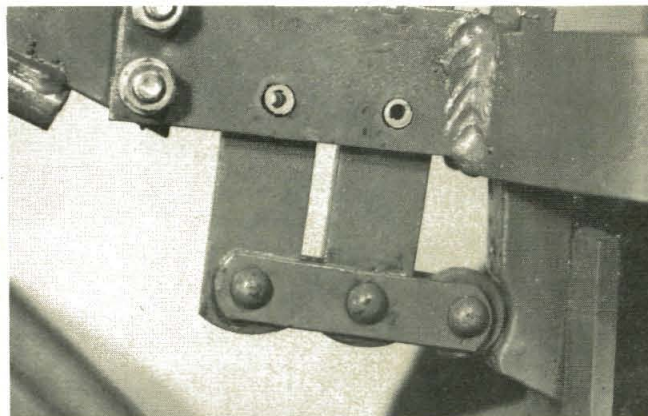

(Photo 2/4) Neutral

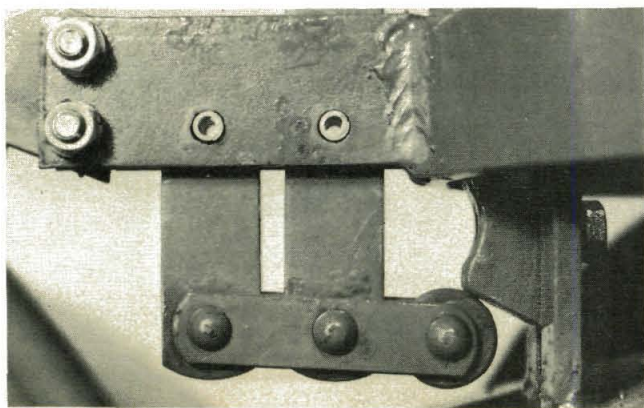

(Photo 2/3) Forward

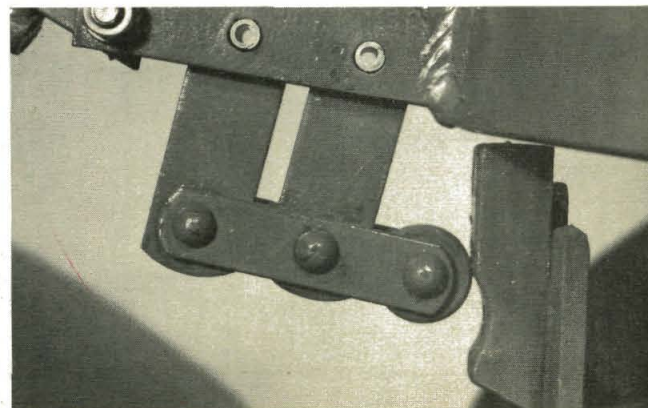

(Photo 2/5) Reverse

WHEEL SPEED SHIFT LEVER—High and Low Speeds/Free Wheeling: Lever on the right side at the operator position controls the wheels. The wheels will not turn unless you shift this lever into gear—see **2** in Photo 2/1. Photos 2/6A, 2/6B, and 2/6C show the Wheel Speed Shift Lever positions for High Speed (**A**), Free Wheeling (**B**), and Low Speed (**C**).

1. For Low Speed, shift the Wheel Speed Shift Lever down and gently roll the tiller back and forth a few inches to engage the gears. When this lever is in gear, you will no longer be able to roll the tiller. To protect the gears, always shift the Wheel Speed Shift Lever when the Forward/Reverse Lever is in Neutral.

2. For High Speed tilling and cultivating, shift the Wheel Speed Shift Lever upward and roll the wheels a few inches to engage the gears. See **2** in Photo 2/1. Again, make sure that the Forward/Reverse Lever is in Neutral before you attempt to change wheel speeds.

3. For Free Wheeling—to move the tiller about without power—simply put the Wheel Speed Shift Lever *in between* High and Low gear positions. There should be no “clicking noise” from the rolling wheels when you’re completely out of gear. If you hear such a noise, just shift the lever a little more in one direction or the other to eliminate the noise—and the rubbing of the gear that causes it—see Photo 2/6 (**B**).

PLEASE don't use the Wheel Speed Shift Lever to stop tiller motion. When the wheels are turning the gears are locked and it is very difficult to move the Wheel Speed Shift Lever out of gear. *Instead, use the Forward/Reverse Lever to stop tiller motion.* Then, if you wish to change wheel speeds, you can do so freely.

CAUTION: If you put the tiller in Reverse while the wheels are in *high* gear, the reverse motion will also be at the faster speed. It's best to use reverse in *low* gear always—at least until you're sure you can handle it while reversing in the higher gear.



(Photo 2/6A) Lever up high.



(Photo 2/6B) Lever in middle level.



(Photo 2/6C) Lever down low.

THE DEPTH REGULATOR—From Setting of Tines Not-Touching-Surface to their Maximum Tilling Depth—Three components make up the Depth Regulator, although we all frequently refer to the Depth Adjustment Bar alone as the “regulator.” See Sketch 2/7 for an illustration of the Depth regulating assembly. This important control allows the operator to select a suitable tilling depth and get a uniformly deep and even seedbed. It also has a “travel” setting which allows for moving the tiller from shed to garden without disturbing the lawn or driveway surfaces. See **3** in Photo 2/1 and Photo 5/1 in Section 5, page 56.

1. To adjust tilling depth, pull the lowest lever in the center of photo first back toward you, and then upward for deeper tilling. The bar will lock at any of 8 positions you select. Lift gently on the handlebars while you adjust the depth regulator. Photo 2/8.

2. For more shallow tilling, such as going from 5th notch back up to 3rd notch, pull the lever back and push down.

3. For traveling to the garden or moving the tiller around under power so the tines will not touch the ground or floor, pull the lever back and push it all the way down to the top notch. (See Photo 2/9.) This is also the position to set the Depth Adjustment Bar when putting motor oil in your new 6 HP Tecumseh-Lauson engine. See Section 1, page 21, for adding oil to 7 HP Kohler engine.

The closeup, Sketch 2/7, shows how the spring and plunger assembly of the depth regulator work with the rear hood bracket. Pulling back on the depth adjustment bar compresses the spring and moves the plunger back. At the same time, the motion of the bar also moves the slot in the bar away from the spirol pin in the hood bracket. If you lift the bar up to a lower slot and release backward pressure, the spring and plunger will push the bar forward to engage the pin with the slot you have selected.

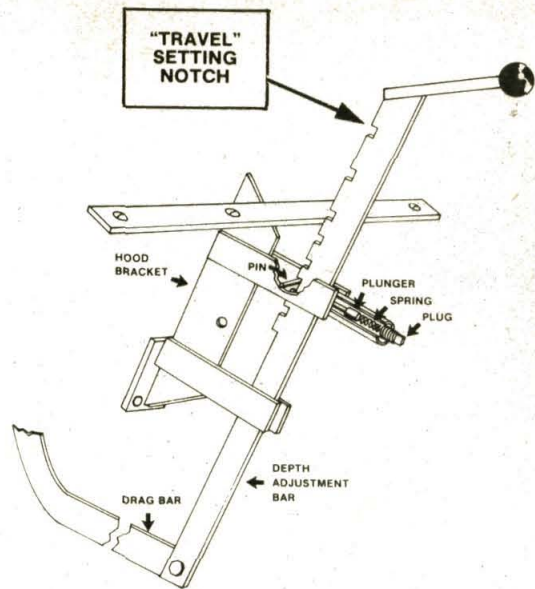

(Sketch 2/7) Depth Regulator



(Photo 2/8) To till deeper.



(Photo 2/9) For shallower depth.

HANDLEBARS—4 in Photo 2/1, the handlebars on your Troy-Bilt Horse Model Tiller are used to guide your machine through the garden, to turn the tiller at the end of each row, and also to lift the tines out of the ground when you want to stop chopping or tilling. Also, when you adjust the depth regulator, you may need to lift up gently on the handlebars.

You will find that the **handlebar height adjustment** is quite flexible and easy to obtain with the single lever control knob. (See **5** in Photo 2/1). See Section 1, page 22, on how to adjust handlebars for a *perfect* height, ideally suited to your requirements.

Normally, the handlebars should be approximately waist-high when the tiller is digging deeply. The adjustment, of course, will vary with individuals. Also, you may find that you will want to set the handlebars at a lower level whenever you are using the Dozer/Snow Blade. It's easier to control the weight and lift the snow blade off the ground with the handlebars in the lower position.

"T" BAR ADJUSTMENT—6 in Photo 2/1, allows the operator to move the entire handlebar base over **to the left or right side of the tiller**, for operation from either side. For various reasons, this may be more convenient for some individuals who wish to walk alongside their tiller without scratching their hands or arms when shallow cultivating right up close to raspberries, fruit trees, roses or other thorny bushes—see Photo 2/10.



(Photo 2/10) To save your hands from being scratched by thorny bushes while tilling close to them, just move the handlebars to one side.

It certainly is not necessary to move the handlebars to operate your Troy-Bilt Tiller in the garden without leaving footprints because, with rare exceptions, all you need is one hand on a single handlebar to operate your tiller, so you can walk on either side of the tiller as you move along.

When you use the handlebars to tilt the tiller over on its "nose" for inspection or maintenance, watch to make sure that you let it down gently. Don't let the front of the tiller down suddenly on a hard surface. You could dent in the engine cover so much that it hits the revolving flywheel. This will cause severe damage to the engine.

NOTE: The "T" bar clamp for the handlebars also covers the gear oil-fill hole of the tiller transmission.

PRACTICE BEFORE YOU START—Before you take your tiller out in the garden for the first time, it's a good idea to learn which lever does what and learn the sequence of operation step-by-step. Practice engaging the levers several times before you start.

First, put the Wheel Speed Shift Lever in high Gear, then Free Wheeling and then, Low Gear. Next, put the Forward/Reverse Lever in Forward, then Neutral, then Reverse position. Notice how you have to hold the lever in Reverse, and how it springs back a very short distance when you let go of the lever. (The Reverse spring automatically returns the lever to Neutral when you let go.—See Photo 2/11).



(Photo 2/11) When let go in Reverse, lever returns to Neutral.

HOW YOUR TILLER'S CONTROLS FUNCTION

THE FORWARD/REVERSE LEVER—When you push down on the Forward/Reverse Lever, it raises the engine and its mount upward and tightens the belts which drive the tiller forward, when the engine is running. See Photo 2/12.

speed gear while the gear is turning, the tiller will be driven forward, by the wheels at the speed selected—see Photo 2/14. If the clutch is not engaged with a wheel gear, the wheels will not turn but the tines will turn alone.

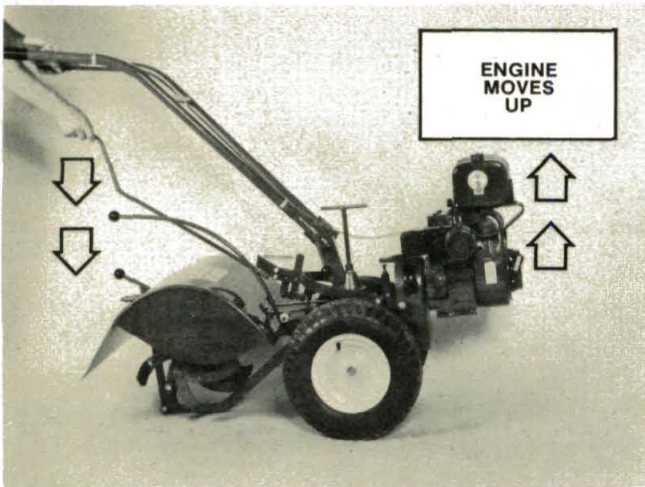

(Photo 2/12) Move lever down.

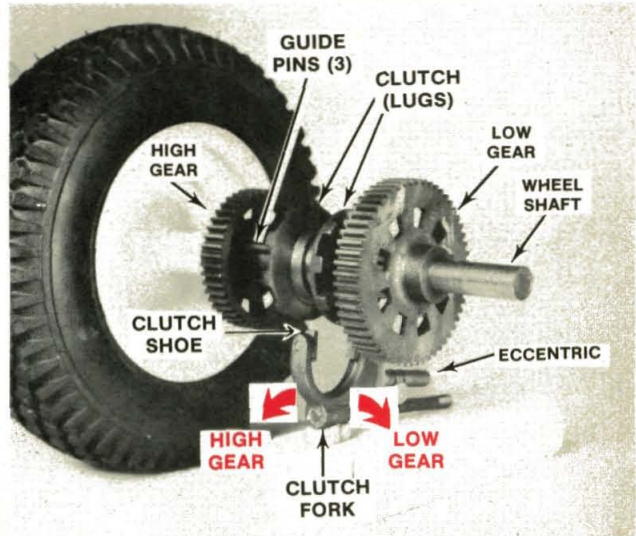

(Photo 2/14)—Operation of Clutch Assembly—Distance separating high and low gears has been exaggerated and clutch fork has been lowered for better visibility and understanding.

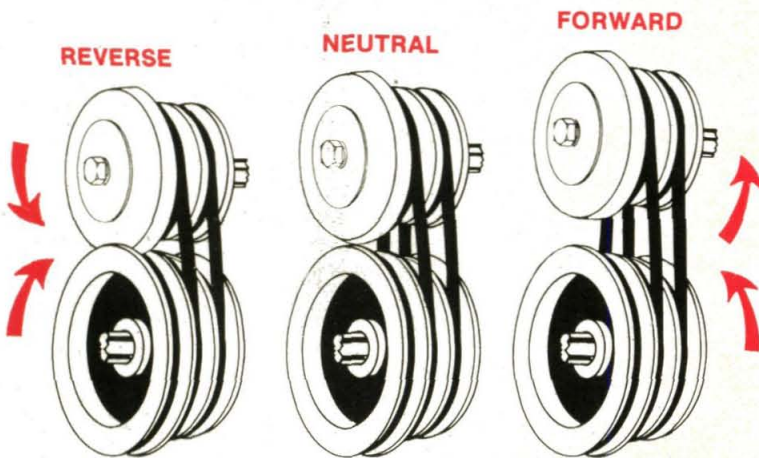

(Sketch 2/13)

What actually happens is that this engine-lifting action by the lever tightens the belts which transmit the power from the rotating engine pulley to the tiller pulley (which drives the tiller transmission, see Sketch 2/13). The main drive shaft of the tiller rotates both the tines and the wheel gears. If the wheel clutch, part #1237, is engaged with either the high or low

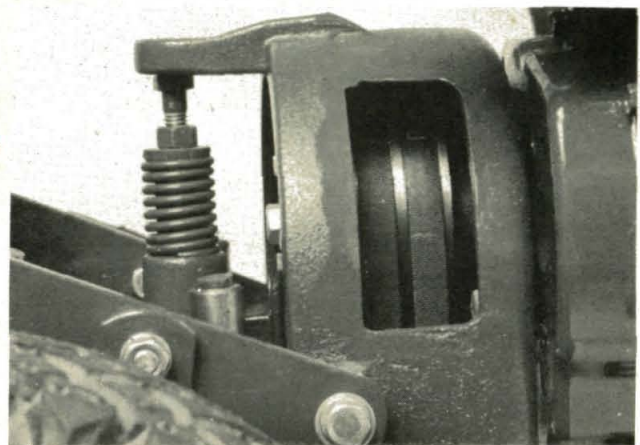

(Photo 2/15) Engine mount compresses spring.

When you lift the Forward/Reverse Lever upward and hold it in Reverse, the reverse disc is lowered into the transmission drive pulley groove nearest to the operator. This rotates the tiller's main drive shaft in the opposite direction. As a result, the drive shaft turns the wheel and tine gears in the Reverse direction. See Sketch 2/13.

You will note that as you shift the lever into Reverse, the engine mount comes down to press on the Reverse Adjustment Bolt—see Photo 2/15. This action compresses the Reverse Spring and Plunger Assembly, requiring you to hold the Forward/Reverse Lever up in Reverse. When you let go of the lever, the spring automatically pushes the lever back into neutral position and all tiller motion ceases. The engine, of course, will continue to run. Because the Forward/Reverse Lever is in Neutral, the upper (engine) pulley and the belts will turn, but will not power the tiller in either direction.



(Photo 2/16) Alternate shift method.

Automatic, “coming-out-of-Reverse into **Neutral**” is an **important safety feature for the operator’s protection**. Please make certain that this safety feature is always working properly, and if it needs adjustment, refer to Section 7, page 102, “How to Adjust and Maintain Reverse.” This section gives instructions for proper adjustment and testing of this control.

IMPORTANT: For safety’s sake, it is best to **shift into reverse in low wheel speed**, especially if the engine throttle is set to run at high speed. Many people *never* shift into reverse while in high wheel speed. This is a good rule to follow.

To stop tiller motion, simply move the Forward/Reverse Lever into the Neutral position.

WHEEL SPEED SHIFT LEVER—Shifting the Wheel Speed Shift Lever up or down moves the clutch inside the tiller transmission to the left or right to engage a high speed or a low speed gear. (See Photo 2/14). No power is provided to the wheels unless the clutch (inside the transmission) and one wheel speed gear are engaged, **AND** the Forward/Reverse Lever is moved into either forward or reverse position.

Whenever the Forward/Reverse Lever is put in Forward or Reverse, not only do the tines turn—as you can easily see—but the wheel and the pinion gears are constantly turning, unseen in a bath of oil inside the transmission. (This, of course, assumes that the engine is running.)

The faster you run your engine, the faster the main drive shaft turns the wheel and tiller gears. It is for this reason, that we strongly recommend that you always make your speed selection and shift your wheel shift lever BEFORE you put the Forward/Reverse Lever into Forward or Reverse position. Thus, when you shift gears, you won’t have the wheel gears turning which could jolt the tiller into action, or worse, could break a lug off of the clutch.

The normal sequence for use of the control levers on your Troy-Bilt Tiller is explained in Section 5, page 51 of this manual. Briefly, the order is as follows:

1. Adjust Depth Regulator.
2. Put Forward/Reverse Lever in Neutral.
3. Shift into Low gear.
4. Start engine.
5. Put Forward/Reverse Lever in Forward (or Reverse) to start the tiller motion.

If your tiller is stopped in soft, tilled soil, you can shift wheel speeds by putting the engine throttle at low speed, shift the Forward/Reverse Lever into Forward and then maintain a continuous pressure on the Wheel Speed Shift Lever in the direction of the selected gear. The gear will engage automatically and the tiller will move.

A third method of shifting wheel speeds on your tiller is to keep the wheels stationary (see Photo 2/16) while you apply pressure on the lever towards the gear you select, and simultaneously tilt the tiller forward by lifting up on the handlebars. As you rotate the tiller on its axle in this method, the tiller will “fall” into the gear you choose. It works a very high percentage of the time and of course is an extremely useful method to use when you are stopped, deep in garden soil. Naturally, don’t shift with this method while the tines are revolving.

DEPTH REGULATOR—The depth regulator has a spring-loaded plunger that will allow you to adjust the depth of the drag bar to any of eight positions even while tilling. You will note when you begin, that the depth adjustment bar should be all the way *down* in the top notch and that the tines do not reach the ground in this position. This is most convenient for moving the tiller back and forth either in the garage or barn, or to and from the garden.

When you start tilling in unplowed soil (see Photo 2/17), you normally begin on the *second* notch of the Depth Regulator. After your ground is well tilled, you can increase the depth of your tilling by raising the depth regulator to the third, fourth and ultimately fifth through eighth notches.



(Photo 2/17) Start shallow in new ground.

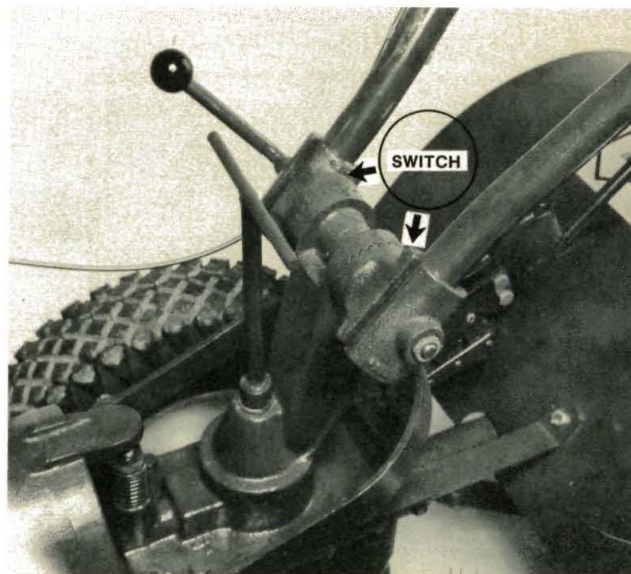

(Photo 2/18) Switch ratchets to vary height.

HANDLEBARS—Height and side-to-side control of the handlebars is discussed on page 32 of this section. But, further observation about the handlebar ratchet adjustments for *height* control can be extremely helpful in getting you just the right setting to suit your needs. For instance, if you have adjusted the handlebar with the Height Adjustment Control, shown above in Photo 2/18, and you are still not satisfied, you can find an adjustment right in between the settings that you had when your tiller arrived by switching ratchets, part #1020-1 and #1020-2.

By inspection, you can see that these inside ratchets have teeth that engage similar teeth in the handlebar mounting base. If you switch the inside ratchets as described above, that is put the one now on the right, on the left side, you will find your handlebar height adjustments will be a few inches higher or lower than they are now. This procedure can be especially helpful in using the Dozer/Snow Blade, or for furrowing. **See these ratchets below.**

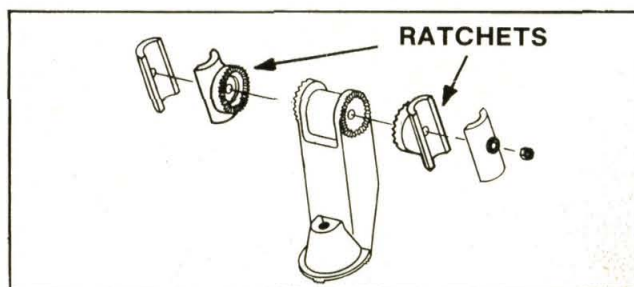

(Sketch 2/19) Switch inside ratchets.

THE TRANSMISSION OIL-FILL HOLE is under the bottom of the handlebar base. It is found by unthreading the "T" bar control and lifting the handlebar, base and all, up off the tiller. First, disconnect the throttle wire from speed control bracket at carburetor, or from control lever on handlebar. Then place the handlebar and base carefully aside on a piece of paper where the base won't pick up dirt that might drop down into the transmission when remounting.

The threaded hole in the top of the transmission cover for the "T" bar clamp also provides an escape for any expanding, heated oil in your transmission. See Sketch 2/20. The oil will merely flow out and reduce any pressure that might buildup during extended periods of tiller operation. It doesn't happen often, since your transmission is not under oil pressure. But don't worry if a little oil does seep out there,

it's perfectly normal *as long as you have checked the oil level hole a few inches above the left wheel shaft.* See Photo 1/8. Oil should not be filled above this hole in the side of the transmission. See section 1, page 19 for transmission oil level and the proper gear oil to use (SAE # 90 or #140).

TILLER LUBRICATION POINTS

Please keep the moving linkages and moving parts that are outside of the tiller transmission well lubricated at all times for far better tiller performance and satisfaction to you.

See Photo 7/1 on page 92 in the Maintenance Section of this manual for an illustration pointing out all of the lubrication points on the tiller and engine controls.

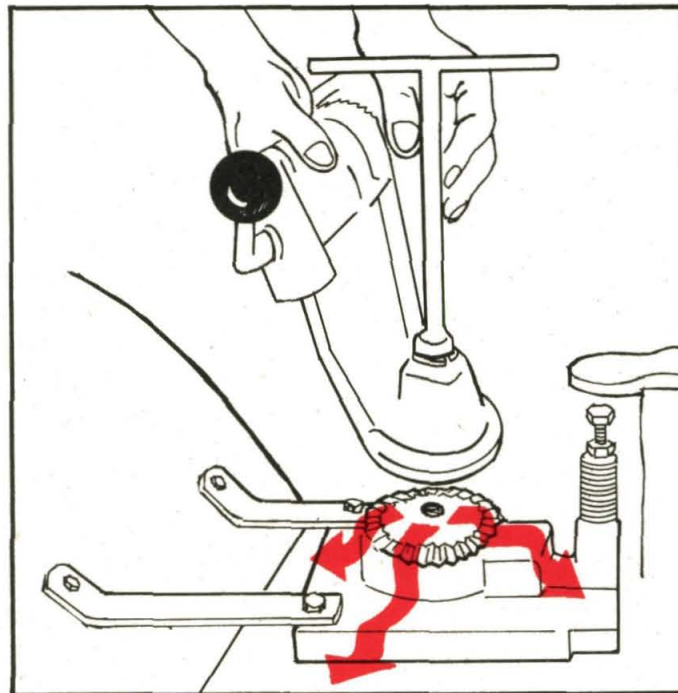

(Sketch 2/20) Don't be concerned about small amounts of oil seepage here.

EXPLANATION OF "RIGHT-HAND" & "LEFT-HAND"

Right-Hand or Left-Hand are determined by standing in the operator position and facing the direction of forward travel.

SAFETY PRECAUTIONS FOR THE OPERATOR

- All power equipment has to be powerful enough to do its job in the garden. However, its power can hurt you if you are forgetful or disregard “common sense” safety practices in normal operation.
- Therefore, please remember to exercise these basic safety rules. They are simply matters of common sense—each based upon knowledge and/or familiarity with operating controls of both the tiller and the engine.
- The safety precautions that you should keep in mind are listed below. Please be sensible in how you use your tiller.

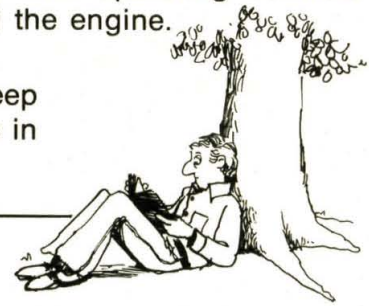

A. BASIC SAFETY RULES

1. KNOW YOUR TILLER & ITS ENGINE. Please don't operate your Troy-Bilt Roto Tiller without first reading the pages with the section numbers in a red square background like the one on the right edge of this page and those like it in Sections 1, 2, 3, 4, and 5 of this manual. The pages with red squares describe where the controls for the tiller and engine are and how to operate them, as well as how to operate the tiller out in the garden.

• STUDY INSTRUCTIONS & PHOTOS FIRST—BE SURE YOU KNOW WHICH CONTROLS DO WHAT BEFORE YOU BEGIN.

2. Practice operating controls and running tiller *BEFORE* you start to garden with it. These moments will prove well worth the time you spend.

3. Don't wear loose clothing that might get caught in moving parts of the tiller or its engine, such as belts, pulleys, tires, or shift linkages.

4. Keep hands and feet away from the tiller tines, belts, pulleys and wheels while the engine is running.

5. Don't let children play with the tiller.

6. When lending your Troy-Bilt to someone else, be sure to instruct them on proper use of the tiller, including safety precautions, before letting them operate it.

7. Don't till near underground electric cables, irrigation pipes or hoses.

8. Make sure that you wear good, sturdy shoes. Never till in bare feet or sneakers.

B. RULES FOR OPERATING AND ADJUSTING THE TILLER

1. Even with tools, don't make adjustments of belts, handlebars, shift linkages, levers, reverse disc, or reverse spring and plunger while the engine is running.

2. Keep hands and feet away from revolving tines, and keep hands away from belts, pulleys, turning wheels or shafts.

3. Always keep the flap on the tiller cover down when your tiller is in operation, except when furrowing and hilling.

4. Don't use reverse in high gear unless you mean to, and can handle it.

5. Use your good sense and judgement at all times. For instance, don't engage powered tines in the ground when wheel shift is in Free Wheeling. Unless held back, the tiller will travel rapidly away from you.

6. Don't try to till on a hill that is too steep for safety.

7. When heading up or down a steep hill, don't shift gears. If you accidentally put the wheel speed lever in Free Wheeling, your tiller could roll out of control. If you must shift on a hill, reduce tiller motion down to slow speed, then turn across the hill before you shift gears.

8. Don't try to remove debris, or untangle vegetation while the tines are in motion. Put Wheel Speed Shift Lever in Free Wheel position. Raise the tines out of the soil. Then, reverse the direction of the tines. The tines will usually unwind themselves when you go forward again. If that doesn't work, stop the tiller and the engine before cleaning the tines.

9. **PLEASE REMEMBER**, you can always stop tiller motion very quickly by putting the Forward/Reverse Lever into Neutral position.

10. Don't go in Reverse and back yourself into a solid obstruction such as a wall, garage door, tree or a fence.

11. For safety's sake, remove the tines when snow plowing. Revolving tines could be dangerous on icy sidewalks or driveways. Removing the tines also aids in banking snow as their absence allows the rear of the tiller to be set down further and the Dozer Blade to be raised higher off the ground.



C. RULES FOR OPERATING THE ENGINE

1. Always make sure that the Forward/Reverse lever is in Neutral when starting the engine.

2. HOT ENGINES AND HOT OR CORRODED MUFFLERS CAN CAUSE EXPLOSIONS—

Allow a hot engine to cool down before refueling tank. Wipe up spills of fuel before restarting engine. Never fill tank while engine is running, or smoke while refueling tank.

3. Never smoke or cause flames or sparks to occur near the battery. Sparks or flames could cause an explosion.

4. POISON/DANGER—Causes Severe Burns—

Your battery contains sulfuric acid—avoid contact with skin, eyes or clothing. **Antidote: EXTERNAL**—Flush immediately with lots of water. **INTERNAL**—Drink large quantities of water or milk. Follow with milk of magnesia, beaten egg or vegetable oil. Call physician immediately. **Eyes**—Flush with water for 15 minutes and get prompt medical attention.

Batteries produce explosive gases. Keep sparks, flame, cigarettes away. Ventilate when charging or using in enclosed space. Always shield eyes when working near batteries. **KEEP OUT OF REACH OF CHILDREN.**

5. Keep throttle cable on electric start tillers away from the battery and its cables. Route the cable straight down the handlebars as shown in Photo 1/19 on page 23. The throttle cable will become hot if it touches the battery's positive terminal.

6. Don't put hands or fingers near the flywheel or its covering while the engine is running. Don't put any tool or object inside of the flywheel cover (engine shroud) while it is running. It is turning at a very high speed.

7. After running the engine, don't touch the muffler until it has cooled down.

8. Don't run engine in an enclosed room or building. Open windows and doors if you must run it indoors for a very short period.

ENGINE CONTROLS & OPERATION

BASIC ENGINE INFORMATION

All Troy-Bilt Roto Tiller-Power Composters use four cycle engines. The engine on your Troy-Bilt Tiller has an oil reservoir to lubricate it by a splash and spray system. It is very important to make sure that your engine gets enough oil for lubrication at all times.

Small air-cooled engines—such as those used in most gardening equipment, including your Tiller—generate a lot of heat during operation. This heat has to be taken away from the engine, otherwise it could seriously damage it.

YOU SHOULD CLEAN DIRT FROM COOLING FINS

A combination of air cooling and oil lubrication systems controls engine heat. Vanes on the engine flywheel blow air through cooling fins on the engine to keep engine parts cooled to safe operating limits as shown in Photo 4/1. Engine covers and shrouds are engineered to aid in control of this air flow. A system of oil passages throughout the engine lubricates engine parts and avoids a buildup of excessive engine heat due to friction.

Using the correct type of clean oil and regular cleaning of dirt and debris from the engine's cooling fins will give you better, more efficient engine service and longer engine life. See Photo 4/2.

YOU SHOULD KEEP THE AIR CLEANER DIRT FREE

Please remember the importance of your air filter. At normal operating speeds, your engine consumes about 8,000 gallons of air (at normal atmospheric pressure) for every gallon of gasoline it burns.

With a ratio of 8,000 to 1, the need for clean air is obvious. A clean air filter—or a new one when the old one has become too clogged up so that it will no longer remove all of the dirt—and tight fitting, “like-new” air cleaner gaskets are essential. Inspect carefully for signs of a dirty air cleaner and loose gaskets. Even small air leaks can suck in large amounts of dirt,

grime or grit in a short time and send these ruinous particles directly into your engine.

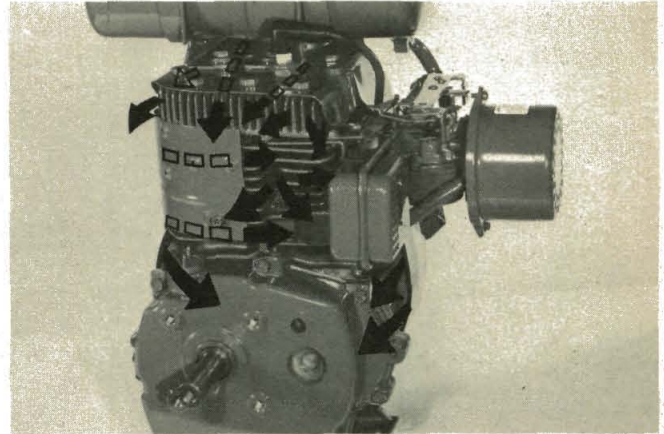

(Photo 4/1) Cooling air flows underneath covers (clear arrows) and carries heat away from engine (black arrows).

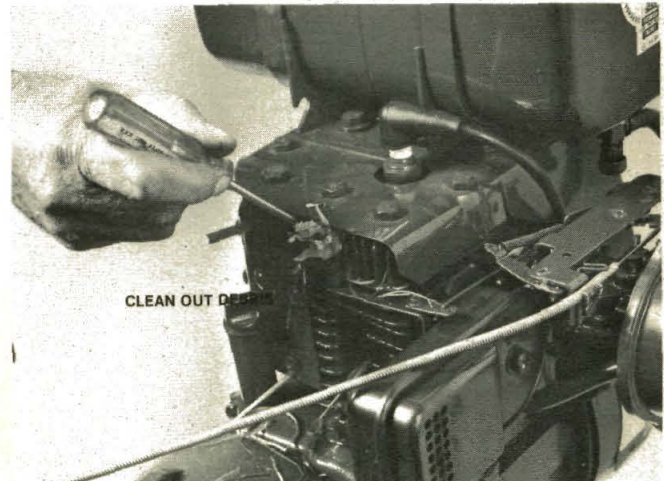

(Photo 4/2) Clean cooling fins.



(Sketch 4/3)

Look for SE in either place

This is SE classified oil.

CHANGE ENGINE OIL AT THESE INTERVALS

Change the engine oil after the *first two* operating hours (about one tankful of fuel). Then, change oil every ten hours, or sooner if tilling in dusty, dry soil. This is more often than the engine manufacturer recommends—but it will pay good dividends, an engine that will last and last. It's normal for engine oil to get black, but check the oil for grime, dirt and grit—then, change it when needed, no matter how few operating hours you have used that oil.

IMPORTANT: When tilling in extremely dusty

practice of giving your engine a “rest” period, will improve fuel economy and will add years to the life of your engine. It will also cool down a hot engine, if its cooling fins are not clogged with dirt.

HELPFUL INFORMATION ABOUT MOTOR OIL

We suggest

6 HP ENGINES—TECUMSEH-LAUSON

Photos 4/4 and 4/5 below show a 6 HP Standard Start and a 6 HP Electric Starting engine—both manufactured by Tecumseh Products Company (Lauson Division). On both 6 HP engines (standard or electric start), the choke is engaged manually. You obtain high speed by opening the throttle lever on the handlebar all of the way (pulling toward your left). See Photo 4/6 & 4/7.

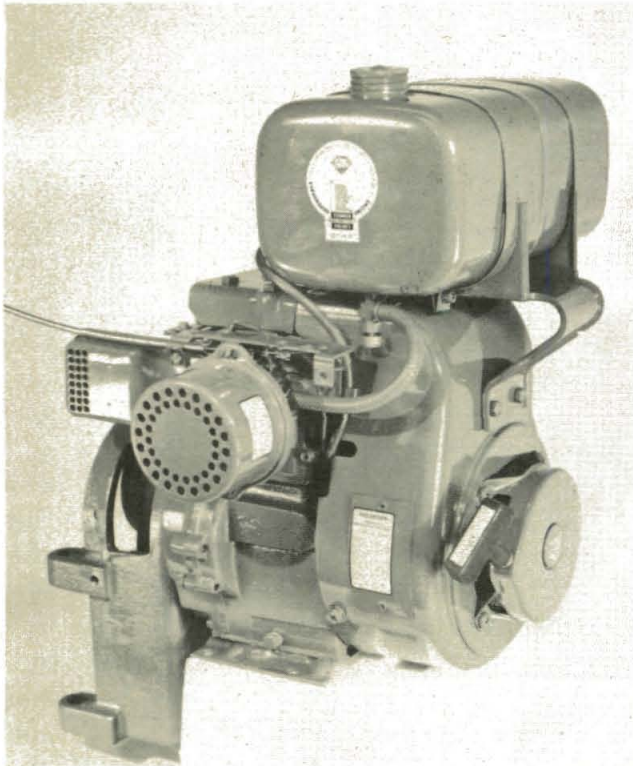

(Photo 4/4) 6 HP engine

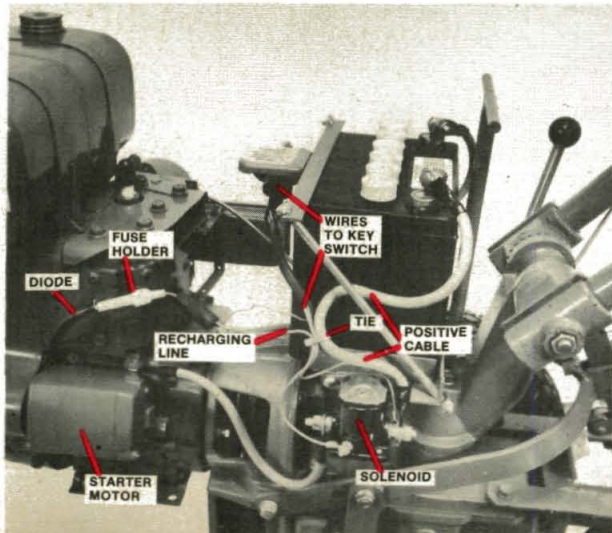

(Photo 4/5) 6 HP electric start

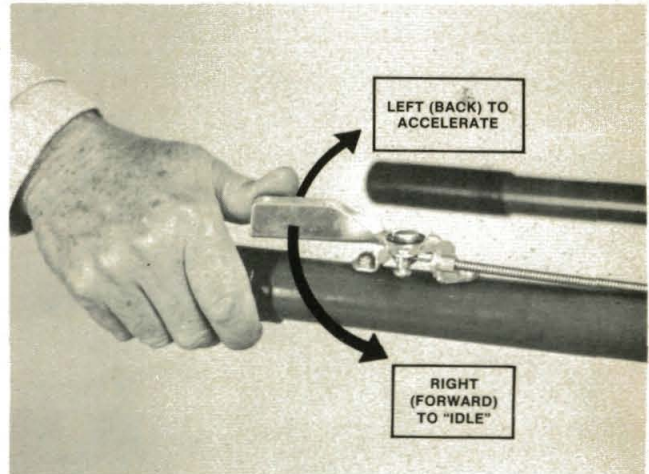

(Photo) 4/6) Throttle lever on handlebar

If you close the lever, by moving it all the way to your right, it will engage the engine shutoff switch, automatically shutting off the engine. See Photo 4/6. In between the shutoff switch and high speed is the full range of engine operations from idle (forward) to full power (back toward you). See Photo 4/7 for illustration of the various positions. Please make sure that you don't operate the tiller under a load without seeing to it that the choke is fully open (disengaged). See Photo 4/8B. Failure to do so can quickly build up deposits that are harmful to your engine.

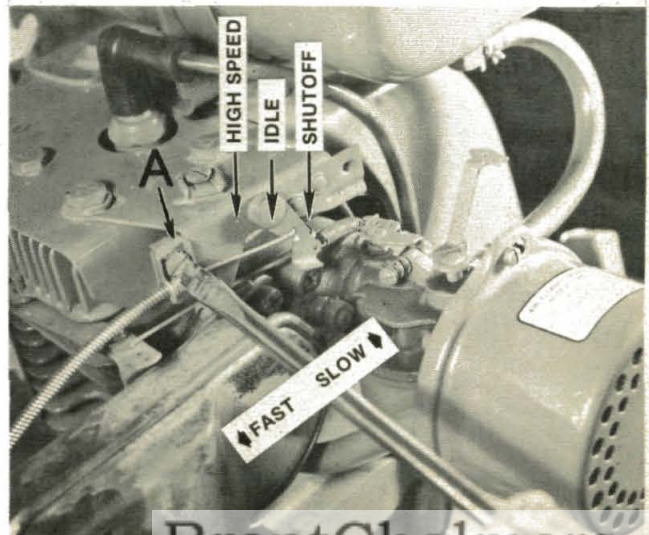

(Photo 4/7) 6 HP, speed control

CHOKE

Down on the carburetor, you will note an arrow on top of the choke lever. Push the lever all the way in for FULL CHOKE. Half way in is HALF CHOKE. Outward (closest to you) is the CHOKE OFF position, Photo 4/8B. See Photos 4/8 and 4/8A for full and partial choke positions.

When the choke is engaged fully (closed), the gasoline-to-air mixture is richest. This, of course, helps your engine to start more quickly.

4

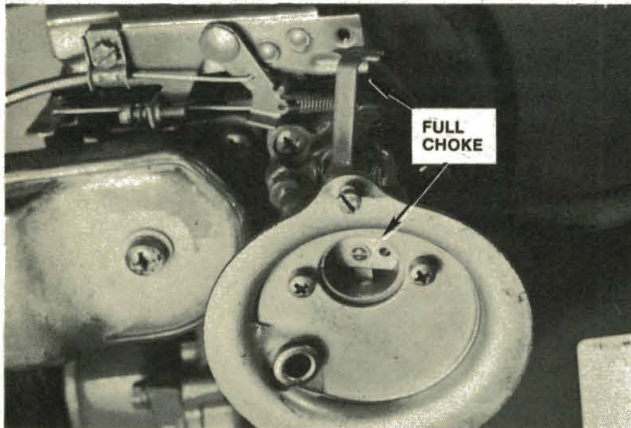

(Photo 4/8) 6 HP engine, full choke.

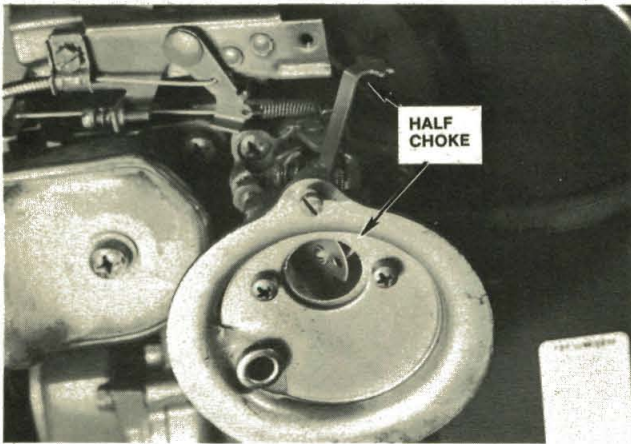

(Photo 4/8A) Half choke.

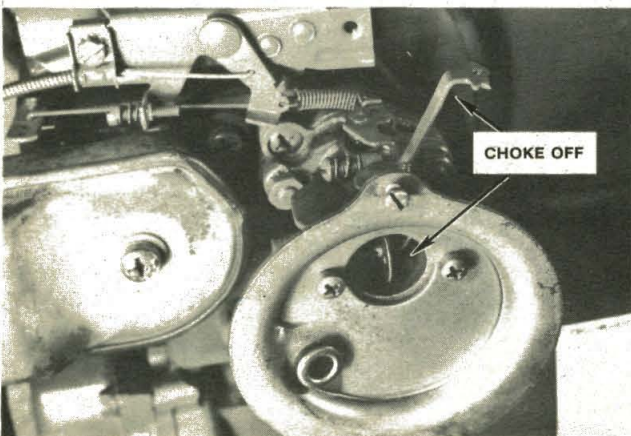

(Photo 4/8B) Choke off.

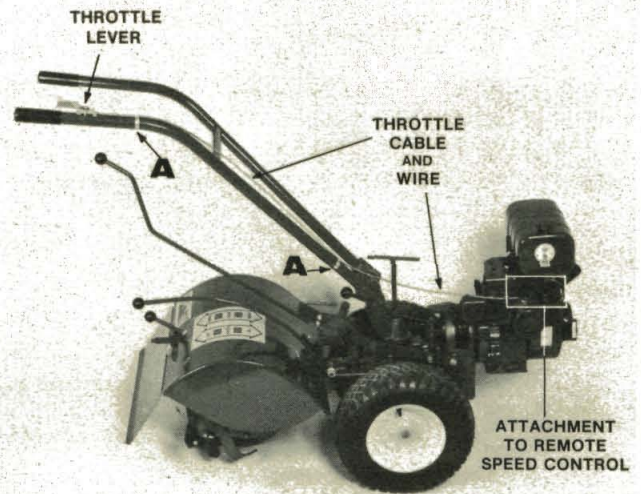

(Photo 4/9) 6 HP engine

Once the engine has started, move the choke to HALF CHOKE briefly, then disengage it when the engine is warm enough to start tilling.

THROTTLE CABLE

The throttle lever on the handlebar connects to the throttle wire and a casing. The wire itself runs through the casing. The cable runs down the outside of the handlebar. The cable is held in place with two spring clips that snap over the bar—one just above the crossbar of the right handlebar and one about ten inches above the bottom of the handlebar. Please see Photo 4/9 for placement of the cable and clips.

On all engines, the throttle cable runs down the handlebar and crosses over to the engine (behind the muffler) where it attaches to a bracket. Don't run the throttle cable of an electric start tiller across the top of the battery. It could cause a short circuit with the battery and even make the wire hot enough to melt (see Photo 4/10).



(Photo 4/10) Run throttle cable on electric start tillers down handlebars, as shown. Keep the throttle cable away from battery—6 HP electric start engine.

After the throttle cable crosses over to the engine, the casing is held securely by the bracket clamp (see **A** in Photo 4/7). The copper clad wire itself emerges from the casing and hooks up to a hole in the remote speed control lever above the carburetor. The remote lever is linked back to the governor spring through a series of levers and springs.

GOVERNOR

Your engine has a built-in mechanical governor that limits engine R.P.M. (revolutions per minute) so that its speed does not exceed limits which could be harmful to the engine. The governor is inside the engine where it can't be seen. See governor lever shown in Photo 4/19.

The faster the engine runs, the more force the governor exerts against the throttle, preventing the engine from overspeeding. For more details on governor operation and its linkage, please turn to page 53.

CARBURETOR

The carburetor, shown in Photo 4/11, supplies a mixture of vaporized gasoline and air to the cylinder. The carburetor includes the carburetor body, throttle, choke and fuel bowl.

It is important to keep dirt, gum and water out of your gasoline so that you can keep passages in the carburetor open and unrestricted. Using clean, fresh fuel will avoid these difficulties.

Underneath the carburetor, you can also see the bowl which holds a supply of gasoline that

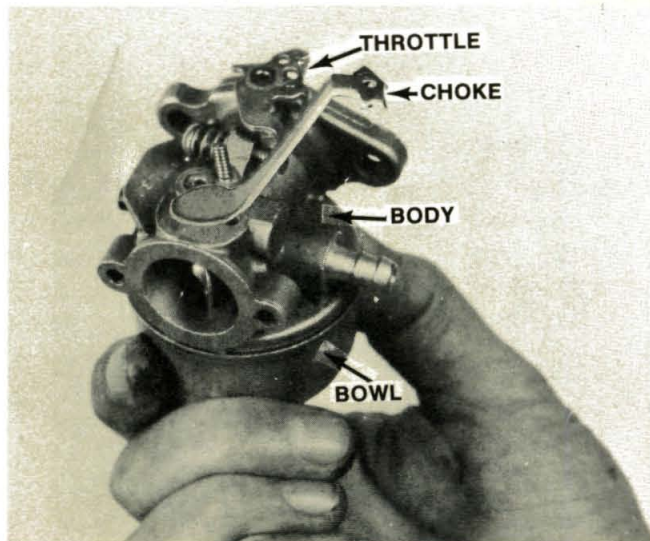

(Photo 4/11) Carburetor for 6 HP engine

is to be delivered to the engine by a float feed system and gravity. Beneath the bowl, you will see the power adjustment screw (large screw with slotted head)—see Photo 4/12.

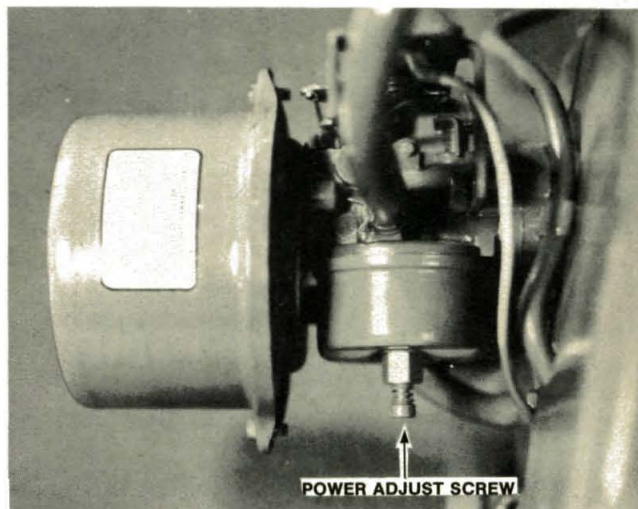

(Photo 4/12) Carburetor—6 HP engine

ENGINE SHUTOFF CLIP

When you close the throttle lever (on the handlebar), it engages a grounding wire at the engine shutoff clip underneath the speed control assembly bracket—see Photo 4/13, which shows the top view. Photo 4/14 shows the view underneath, illustrating how the lever on the assembly completes the gap between the stop switch and the mounting bracket. This stops the engine. Also see Photos 7/42 & 7/44.

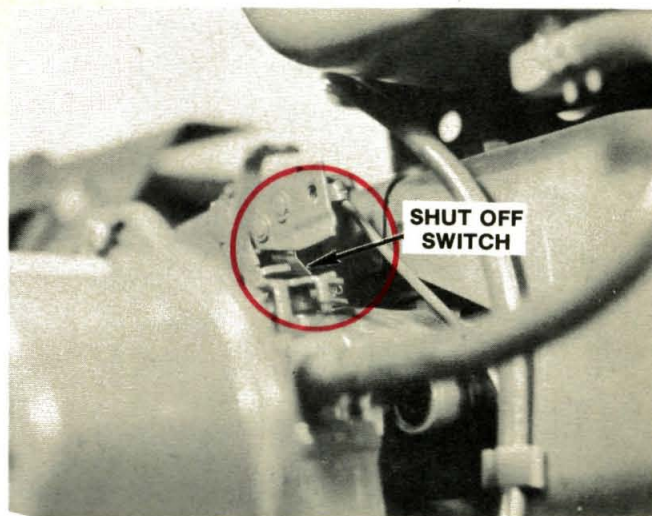

(Photo 4/13) 6 HP engine

ENGINE OIL LEVEL AND THE DIPSTICK

On your new 6 H.P. tiller, you can measure the oil level with the engine at its normal slope mounted on the tiller. Do this on a level floor by setting your tiller depth regulator at the first (top) notch—so the *tines do not touch* the floor and the engine slopes in its normal position. See Photo 4/15.

Always measure engine oil level with the dipstick screwed securely into the oil filler hole. Please keep a close and regular check on your oil for level and cleanliness. It is normal for your engine oil to turn black, but you should constantly check for dirt and grime in the oil (replace dirty oil.) Keep a good gasket on the dipstick and keep the stick tightly in place always.

4

BRAND NEW ENGINES—6 HP

On brand new engines, fill the sump through the oil filler hole with 24½ ounces of #30 SE classification oil. SE should be stamped on the top of the can or printed on the can's label. Check the oil level with the dipstick. (See Photo 4/16).

CHANGING OIL

Change oil more often than recommended by engine manufacturer. **Change the oil after the first two hours (one tankful), then at least every 10 hours of operation thereafter—and sooner in dry and dusty conditions.**

When you are changing engine oil, run the engine for 10 to 15 minutes to heat it up before draining it. This will drain the maximum amount of oil and will also remove the maximum amount of dirt with it. See Photo 4/17 for drain hole locations. You need to remove a drain plug from one side only to drain the oil.

Please remember to tilt the engine base towards the drain hole as the last few ounces drain away. (Put a brick or thick board under one wheel). Often the most dirt is removed in these last few ounces. The extra effort really pays dividends.

It is not too difficult to tilt your tiller towards the engine drain hole by pulling the gas tank and the nearest handlebar towards you. **PLEASE DON'T PUT PRESSURE ON THE AIR CLEANER AND CARBURETOR** to move the tiller at any time. You could easily crack your carburetor that way.

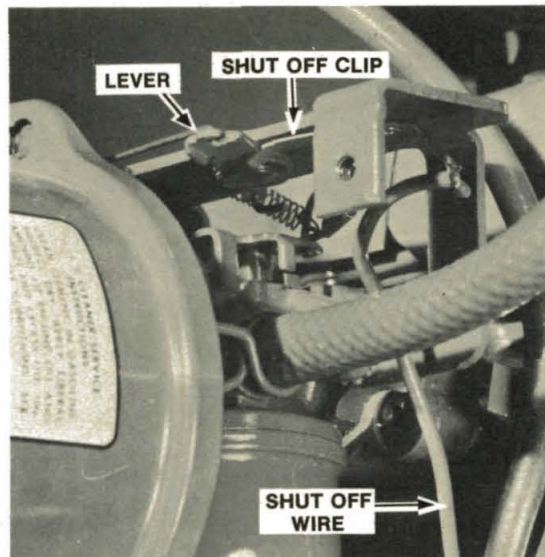

(Photo 4/14) 6 HP engine

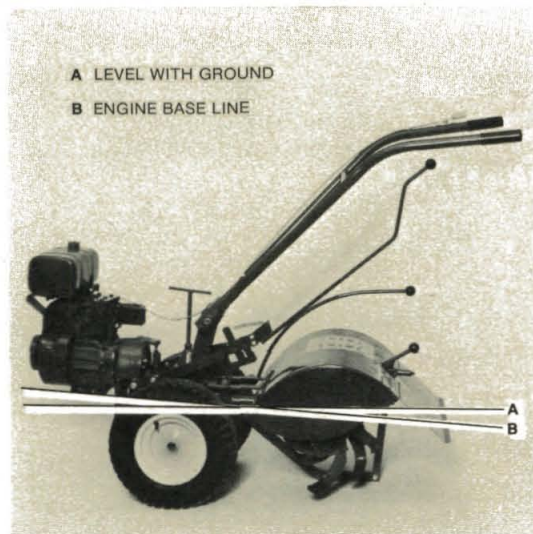

(Photo 4/15) 6 HP Tecumseh engine

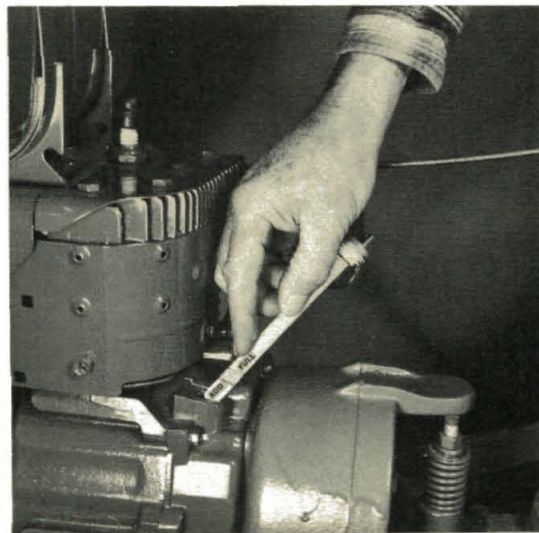

(Photo 4/16) 6 HP engine's dipstick

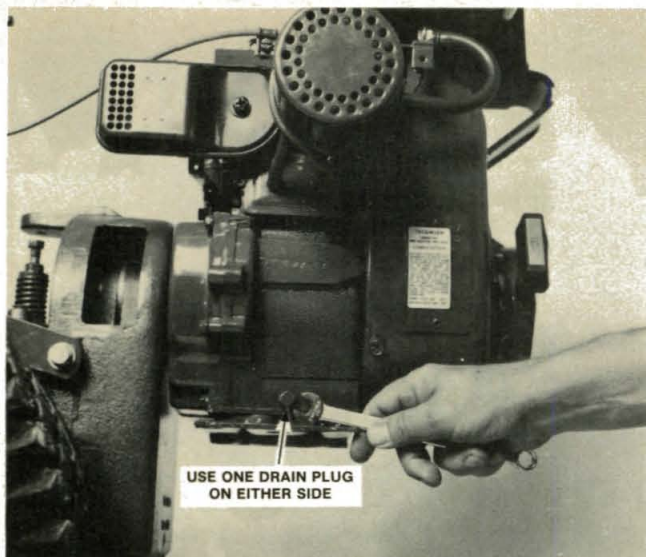

(Photo 4/17) 6 HP engine

When the dirty oil is drained from your engine, replace it with 3 or 4 ounces less than 24½ ounces of clean oil and recheck the oil level with the dipstick as you normally do. If additional oil is required, bring the level up to the "Full" mark shown on the dipstick.

Don't overfill your engine crankcase with oil. An excess of oil will very likely show up by being blown out the breather tube into your air cleaner (sponge filter). (Photo 4/18 shows engine breather tube). This will cause oil to drop from the air cleaner after the engine stops. If your engine drips oil in this manner, check the oil level to make sure that it is not too high. Also, see engine breather under Engine Maintenance in this manual, page 116.

SPARK PLUG

The spark plug, shown in Photo 4/19, of course, provides the spark to the engine to ignite the fuel mixture in the combustion chamber. It is essential to proper engine operation to have a plug with no cracks in the porcelain, or fuel residues or oil deposits on the spark plug electrode itself.

Replace spark plug with a Champion J-8 or equivalent plug. Plug gap should be .030".

AIR CLEANER

The air cleaner of your 6 H.P. engine uses an oil-moistened polyurethane sponge to filter

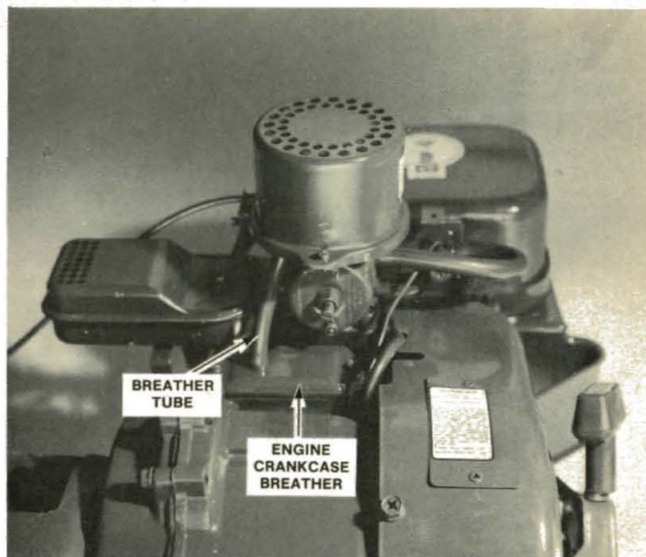

(Photo 4/18) 6 HP engine

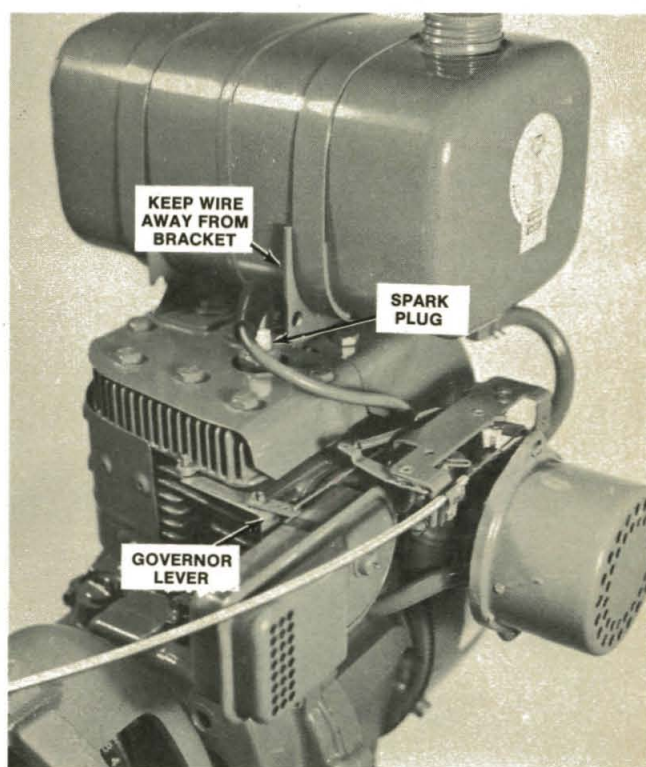

(Photo 4/19) 6 HP engine

dirt out of the air delivered to the engine. These small engines use thousands of gallons of air for every gallon of gasoline, so, you can see how important it is that the air your engine gets is clean and free from dirt and grit. See Photo 4/20.

Please keep the air cleaner clean so that it can trap the dirt and grit before they can reach and ruin the engine. See the Tecumseh Owners

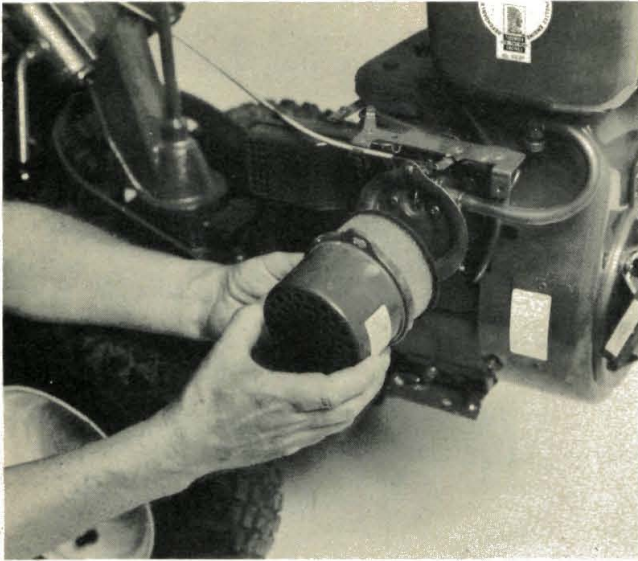

(Photo 4/20) 6 HP engine



(Photo 4/22) Use Forward/Reverse lever to stop.

REFUEL WITH CARE

Clean fuel spills off engine and tiller before operating engine. Don't smoke while refueling. Don't refuel a hot engine. Allow engine and muffler to cool down before filling tank.

(Sketch 4/21)

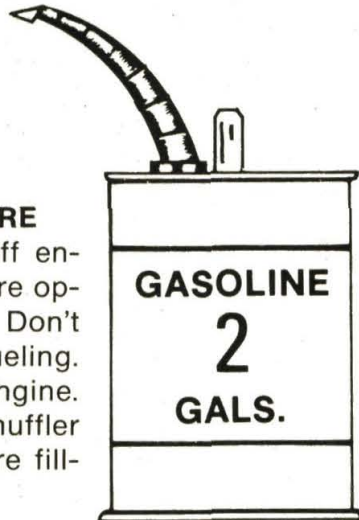

guide and the Engine Maintenance section of this manual for information on how to replace or clean your air cleaner's sponge—see page 112.

GASOLINE

Fresh unleaded automotive gasoline is recommended for the Tecumseh 6 HP engine. (Leaded "Regular" grade is an acceptable substitute.) The fuel tank has a screen to keep dirt out of your carburetor and has a 1½ gallon capacity. *Do not mix with oil.*

Stale gasoline—that has been standing for long periods—develops gum that will foul spark plugs, clog fuel lines, carburetors, floats and screens in the fuel system. Stale gasoline

does not vaporize properly for efficient engine performance.

With unfavorable weather conditions, gasoline containers being stored in garages, barns, sheds or on concrete floors can develop water condensation on their inner walls. The water eventually finds its way to your engine's fuel supply.

Water in the fuel is a fairly common cause for engines not starting, or running roughly. This condition is often mistaken for carburetor adjustment troubles. Many people avoid getting water into their fuel by buying a gallon or two at a time and constantly replacing it with clean, fresh gasoline. To rid your fuel tank of watery or stale fuel, disconnect the fuel line and drain it into a container—**keeping it away from all flames, sparks, cigarettes, or hot engine parts.**

To prevent formation of gum and varnish in gasoline that has been standing for long periods (several months), there is an alternative to draining out the fuel. It is to put one ounce of a product called *STABIL*® in your fuel tank and fill the tank up to the top. This will keep harmful gums from forming for up to one year at a very small cost. An 8 ounce can will cost \$3.00 and can likely be obtained from your local Tecumseh Engine *Distributor*. See page 3 of your Tecumseh engine instructions.

The above is a good method for Winter storage of your tiller, too. You just start your engine right up and consume the *STABIL*, too.

But if your engine won't start in the spring, you can drain the fuel out of the tank and *the carburetor bowl too*. Replace it with clean, fresh gasoline. Then, it won't be hard to start. The real advantage is that your carburetor seals will be kept moist and gums and varnish from stale gasoline will not be formed to gum-up fuel lines and the carburetor passageways.

STARTING THE 6 HP ENGINE

First make sure that the tiller Wheel Speed Shift Lever is in slow speed and the Forward/Reverse Lever is in Neutral before starting the engine.

1. Push the throttle lever to the left, to a slow running position. Then, push the choke lever in to FULL CHOKE (for a cold engine).
2. Pull gently on the starter rope for a few inches until you feel a resistance, then give the starter rope a quick, firm pull. On Electric Start Models, turn the key to "START" and hold it there momentarily. Release the key when the engine starts.
3. As soon as the engine fires and is running, make sure that the throttle lever is at a slow running position and move the choke to HALF CHOKE briefly. Then as the engine warms, move the choke to the OFF position. It's a good practice to let your engine run a good two or three minutes before starting tilling operations. Never till unless the choke is OFF.

After the engine has been operating for ten minutes or more in the garden, it probably won't be necessary to choke the engine at all to restart it.

STOPPING THE ENGINE

1. Push the throttle lever on the handle all the way forward (to the right). This lever will move the throttle wire and the remote speed control lever to the front where the lever contacts the shutoff clip, and stops the engine automatically. If your engine does not shut down under these circumstances, push the choke in to FULL CHOKE to stop the engine, and see the data and Photo 7/63 in this manual for further advice. The lever must contact the shutoff switch (Photo 4/13).

OWNERS PLEASE NOTE:

A properly adjusted Forward/Reverse Lever should make emergency engine shut-offs unnecessary. **You should always be able to stop tiller motion with the Forward/Reverse Lever by lifting the lever into the Neutral position.** This action will stop all machine motion except the engine, the engine pulley and belts. The belts, however, will not provide power to make the tiller move while the lever is in Neutral. See Photo 4/22.

ELECTRIC START SYSTEM ON 6 HP TECUMSEH ENGINE

For hookup and preparation of your 12-volt battery electric start system, please see Section 1, page 24. For service and maintenance and for operation of the engine without a battery or with a dead battery, see note on page 27. For storage of your tiller with electric start remove battery and store in cool, dry place. Temperatures for storage ranging from 10° F to 45° F are best, as long as your battery acid retains its state of charge. You can even store the battery outdoors (in a safe place). If the state of charge is very low when temperatures below freezing occur, you could damage the battery. Never store a battery indoors in a warm place for extended periods.

When the tiller is not going to be used for two or three months, or extended periods such as over the winter, remove the battery from its mounting.

If it is convenient for you to check the battery's condition every 3 or 4 weeks, you could hook the battery back up to the tiller's electric start system. Then, you could start the engine on your tiller (outdoors) and run it for 45 to 60 minutes at intermediate speed. If the engine is started easily with the battery, and the battery acid level in each cell is up between the acid level lines, then that's reasonable evidence that everything is O.K.

IMPORTANT: Check battery acid level every 10 hours of tiller operation.

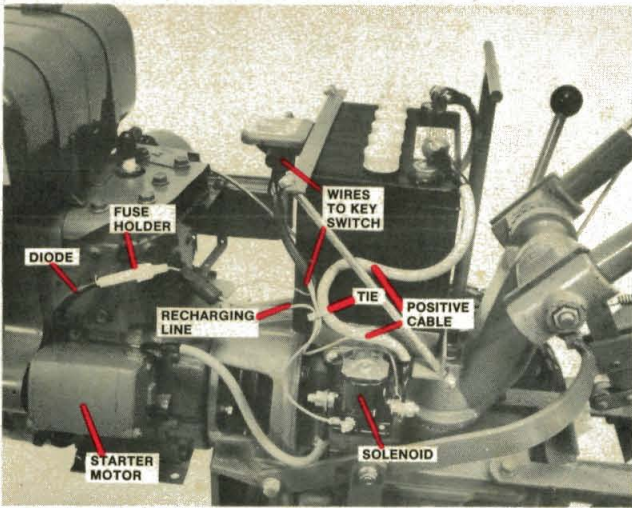

Left side of tiller

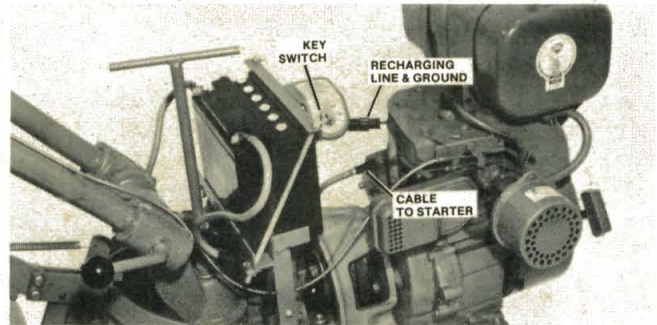

Right side of tiller

(Photo 4/23) The single diode on the 6 H.P. Tecumseh-Lauson electric start engine automatically recharges the battery while the engine is running.

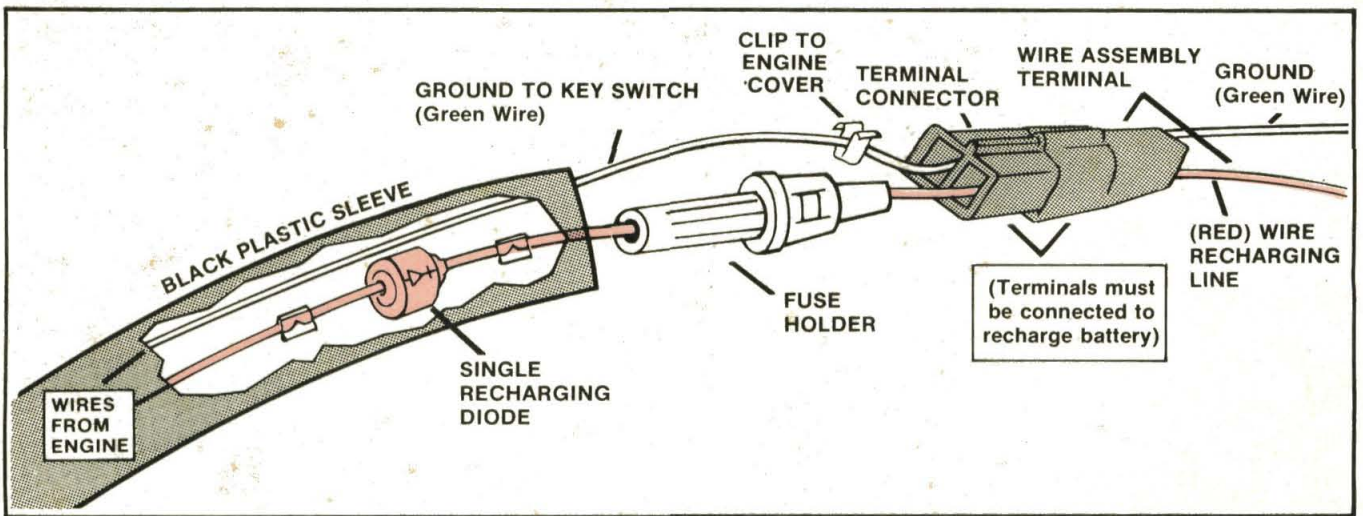

(Sketch 4/24) 6 HP electric start engine battery recharging line and diode details.

**TECUMSEH-LAUSON
6 H.P. ENGINE**

LOCATING ENGINE MODEL NUMBERS

**KOHLER 7 H.P.
ENGINE**

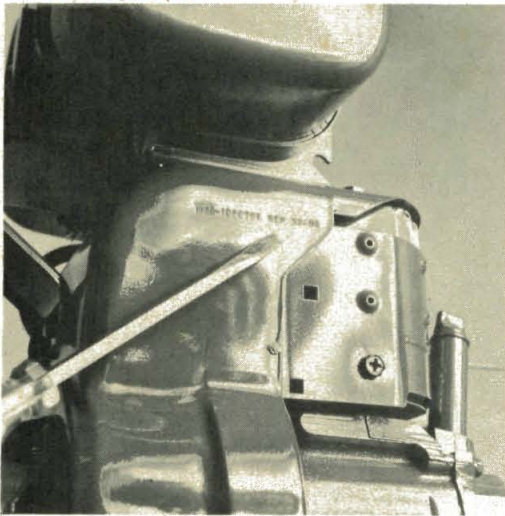

LOOK HERE—On the side of the engine blower housing opposite the starter rope.

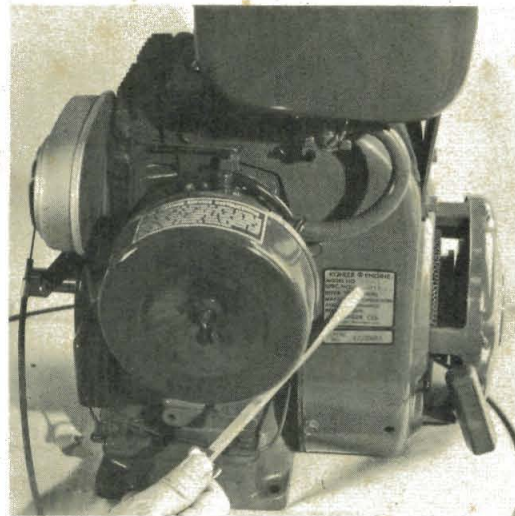

LOOK HERE—Model and spec. nos. on Kohler name plate.

7 H.P. KOHLER ENGINE

Pictured at the right is the 7 horsepower Kohler engine. It is a powerful and durable engine which should last a long, long time, if given proper and regular maintenance. This engine has a manually operated choke and a stop button, both found at the engine. Details of the operation of the throttle, choke, stop button and other engine components are described below under "Controls And Operation."

Please remember to clean the paper air filter element often, check and replace the engine oil (use SE classified oil) on a regular maintenance schedule. Replace the engine oil at least every ten hours, or sooner when tilling conditions are really dusty and you detect or suspect dirt or grit has infiltrated into the engine. Your fuel tank should keep the engine running for two hours or more, so between four and five fuel tanks should be a reasonable interval to change oil.

ADDING OIL

With a *new engine* add 2½ pints of SE rated motor oil of #30 weight (viscosity) to the engine's crankcase. Remove the square capped pipe *plug and dipstick* and fill oil through that hole. SE oil has a higher operating heat range than SC oil. SE can be used where SC is recommended.

When measuring oil level with the dipstick, keep the engine base level and **DO NOT THREAD PLUG INWARD TO MEASURE**, instead, rest the threads of THE PLUG on top of hole. Remove the dipstick to measure the oil level—as shown in Photo 4/26.

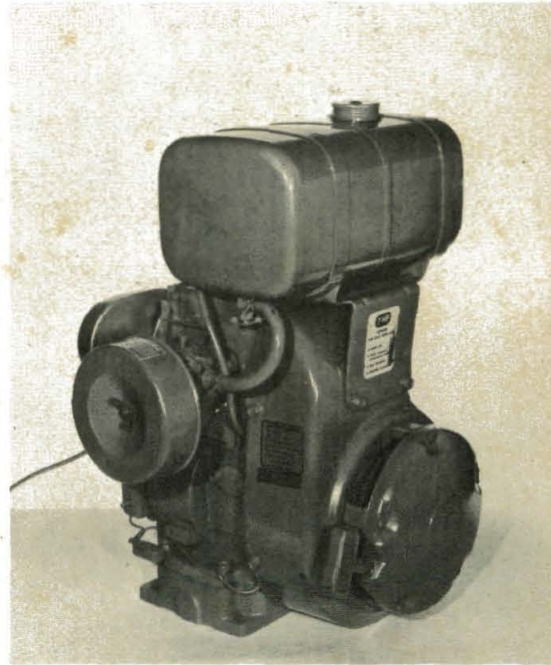

(Photo 4/25) 7 HP Kohler engine.

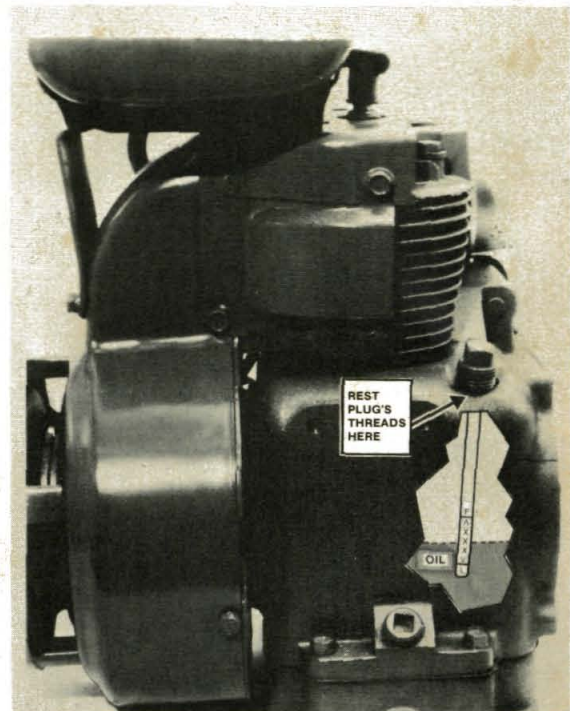

(Photo 4/26) 7 HP engine, rest dipstick's threads on top of hole. Don't thread in.

REPLENISHING OIL

You will note that the capacity of your 7 HP engine is about 1/2 pint more than one quart of motor oil when filling a new engine or a short block for an engine repair. It is assumed that some dirty oil will likely cling to the sidewalls of the engine crankcase, especially if the engine is drained while it is cold. It should take about one quart to bring the new oil up to proper level. Please Note: It is recommended that you run the engine for 10 or 15 minutes to heat the oil up before draining it. This will minimize the amount left in the engine.

Large masses of dirt and grime often come out with the last few ounces of oil, so drain the engine completely by tilting the engine towards the drain hole (put a thick board or brick under one wheel).

4

THROTTLE CABLE

The throttle cable on a 7 HP Troy-Bilt Tiller runs down the right handlebar and dips down outside of the yoke (which raises the engine to tighten the belts) and across to the governor control disc. A small metal clamp and a screw holds the throttle casing in position. See Photo 4/27 for the routing of the cable and the next photo for close up details.

HOOKUP

Once the throttle wire is run through the clamp and installed in the closest, most accessible hole in the governor control disc, then you can secure the cable with the screw as shown in Photo 4/28. Leave a little bit of cable projecting beyond the clamp so it will hold properly.

AIR TEMPERATURE	OIL VISCOSITY
Above 30° F.	30
30° F to 0° F.	10W - 30
Below 0° F.	5W - 20

In general you should use #30 motor oil while tilling in warm weather, and be sure to use oil that has a service classification of SE, which we recommend for use on all engines for Troy-Bilt Tillers. Note that in colder weather multi-viscosity oil is recommended in the above table. Use about one quart of oil for a refill, but let your dipstick be your final guide as to when you have reached the FULL mark on the dipstick.



(Photo 4/27) Route cable outside of yoke.

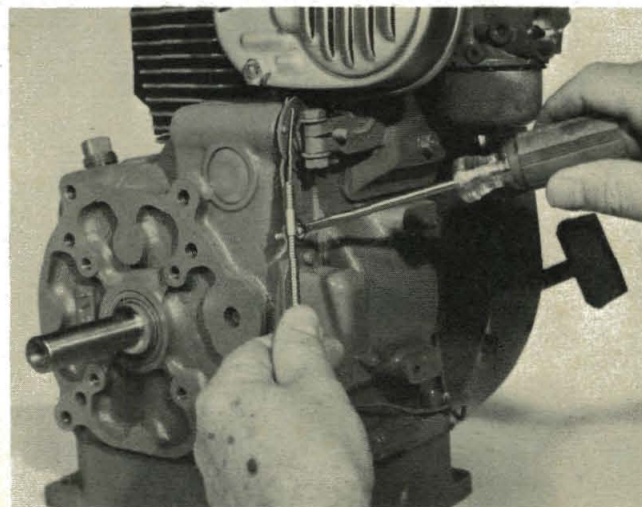

(Photo 4/28) 7HP Kohler engine throttle cable wire goes into first hole of disc. Tighten clamp securely.

CHOKE

The 7 HP Kohler engine uses a manually operated choke shown in FULL Choke position in Photo 4/29. Photos 4/30 and 4/31 show that when the lever is in FULL Choke position, the butterfly closes the air opening to the carburetor, and the choke in the OFF position leaves air an unrestricted passage into the carburetor. So, in starting a cold engine with FULL choke in use, the fuel mixture going through the carburetor will be very rich. Be very sure to turn your choke off promptly when the engine has started. Running an engine under heavy workloads with the choke on FULL can cause excessive carbon buildup and do harm to the engine.

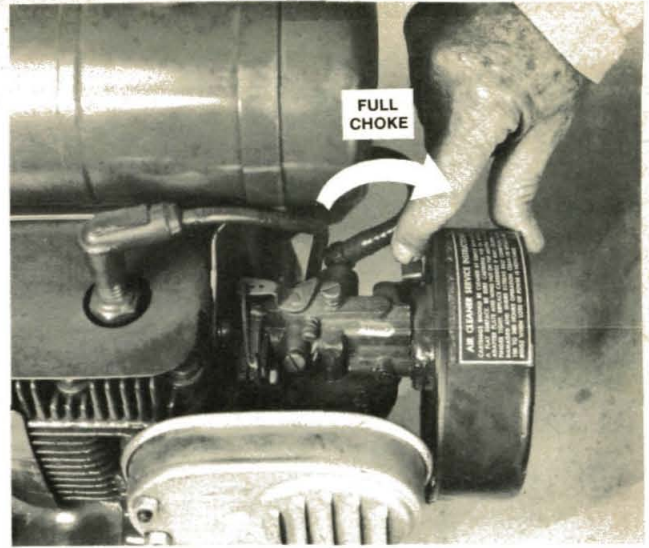

(Photo 4/29) Move choke **toward** you for FULL Choke, **away** from you for Choke OFF position.

4

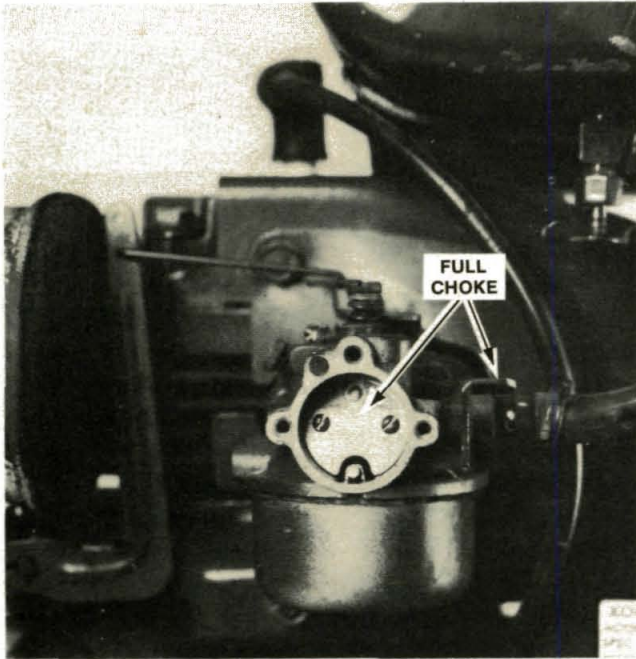

(Photo 4/30) FULL Choke, butterfly closes.

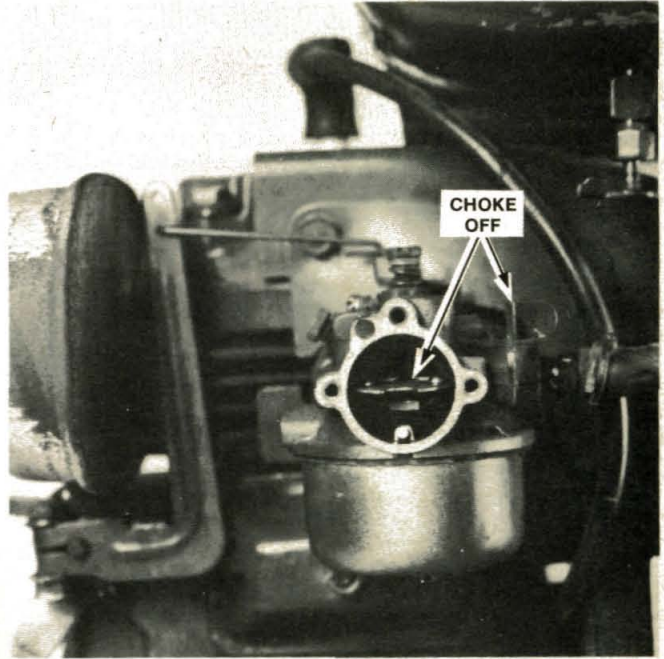

(Photo 4/31) Choke OFF, butterfly opens.

ENGINE STOP BUTTON

To the left of the air filter, between it and the throttle cable, you'll find the engine stop button. Push it in and hold it in, to stop the engine—see Photo 4/32. Underneath the cover with the stop button are the engine's breaker points.

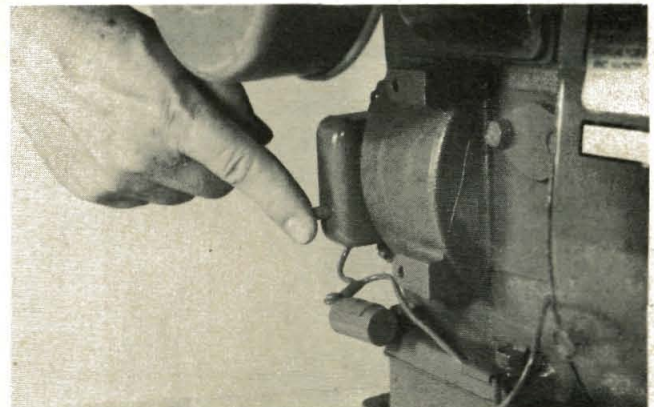

(Photo 4/32) Push in on stop button and hold it in, to stop engine.

STARTING 7 H.P. ENGINE

Instructions for starting the Kohler engine are as follows: First, make sure that the tiller Forward/Reverse Lever is in the Neutral position and the Wheel Speed Shift Lever is in Low Speed position.

1. Turn on the fuel valve under the gas tank.
2. Move the choke to the FULL choke position shown in Photo 4/29.
3. Just crack open the throttle lever on the handlebar a very small amount. (Avoid flooding the engine with fuel.) Kohler engines have a very fine automatic compression release called ACR which makes starting your 7 HP engine very easy.
4. Pull the rope, recoil starter.
5. After the engine is running, gradually return the choke to the "Open" position.

STOPPING THE KOHLER ENGINE

1. Put the tiller Forward/Reverse Lever in Neutral position.
2. Push the stop button and hold the button in until the engine stops. The stop button is shown in Photo 4/32 of this manual.
3. Turn the fuel valve off.

In an emergency, to stop the engine, or if the engine continues to run when the ignition is turned off, apply FULL choke and open the throttle to stall the engine.

GASOLINE

Fill fuel tank with clean, fresh **Regular** grade gasoline. You can use leaded or non-leaded fuel but make sure that the octane rating is at least 90. Don't mix oil with gasoline.

GOVERNOR

Your 7 HP engine has a mechanical governor that can be adjusted for varying speeds as indicated in the Kohler engine pamphlet you received with your tiller. See Photo 4/33 for a closeup view of the external governor controls. The external controls are attached to the governor shaft which leads inside the engine.

GENERAL INFORMATION

Your engine has an automatic compression release system which makes it easy to pull the engine through for starting.

The breaker points for your engine are mounted outside the engine under the same cover used by the stop button. For service of these points, see your Kohler engine pamphlet under Ignition System Service. The breaker points are shown in Photo 4/34. Your engine pamphlet will show you how to adjust the points. The condenser is shown in Photo 4/34 below the breaker points (outside of the cover).

When putting the engine away, after it has cooled down, it is good practice to pull the starter cord slowly until you feel engine compression resisting your pull. This means that both valves in the engine are closed. Leaving the valves closed when the engine is not being used can help prevent the entrance of moisture into your engine.

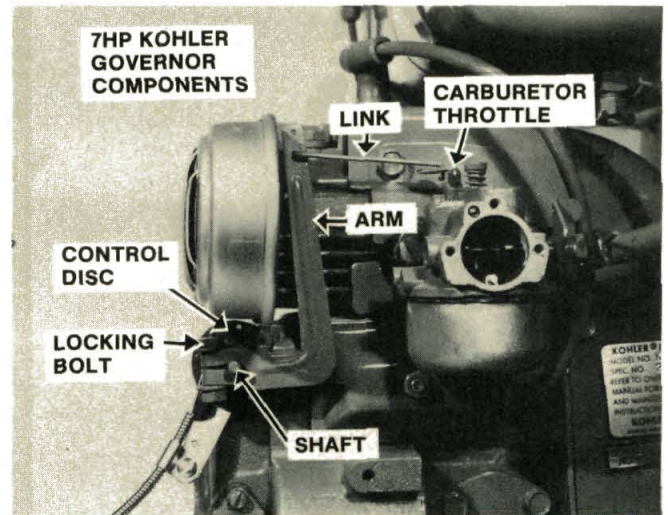

(Photo 4/33) External governor linkage for 7 HP Kohler engine.

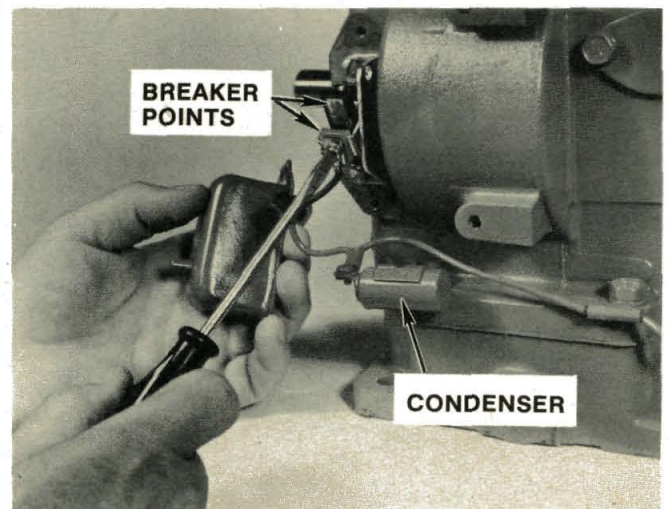

(Photo 4/34) Breaker points and condenser are externally mounted for easier service.

CARBURETOR

The carburetor shown in Photo 4/35 supplies a mixture of vaporized gasoline and air to the cylinder's combustion chamber. The carburetor includes the carburetor body, throttle, choke and fuel bowl.

**IF YOU HAVE AN ENGINE PROBLEM...
FIRST, READ YOUR ENGINE OWNER'S
MANUAL TO SEE IF THE ANSWER
YOU SEEK IS RIGHT THERE.**

The following information provided in this manual is not meant to be a substitute for an Authorized Serviceman for you. It is intended to give you a little helpful background and understanding of what's going on in your engine. Hopefully, it might help you to solve minor problems and understand the need for effective maintenance.

ENGINE COVERS HELP TO COOL ENGINE

Please don't remove any of the engine shroud or covers (see Photo 4/1) in an attempt to "give it more air for cooling." You would be defeating your own purpose. The cooling fins, shroud and covers are carefully designed to direct the greatest volume of air over all points of the engine to avoid uneven heating. Removing a section of these coverings would change the air flow from its designed-in course. This could cause "hot spots" to develop in your engine and could cause damage or even ruin it.

GOVERNOR-6 HP TECUMSEH-LAUSON

Your engine has a mechanical governor which protects the engine by limiting engine speed while it allows the engine to obtain the proper power for varying loads. It very likely won't need any adjustments for years as long as the levers and wires are not bent. So, it's wise not to make unnecessary adjustments to the governor.

Inside the engine mounted on a gear and shaft are a governor spool and two weights that are affected by centrifugal force in relation to engine R.P.M.—see Photo 4/36. The faster the

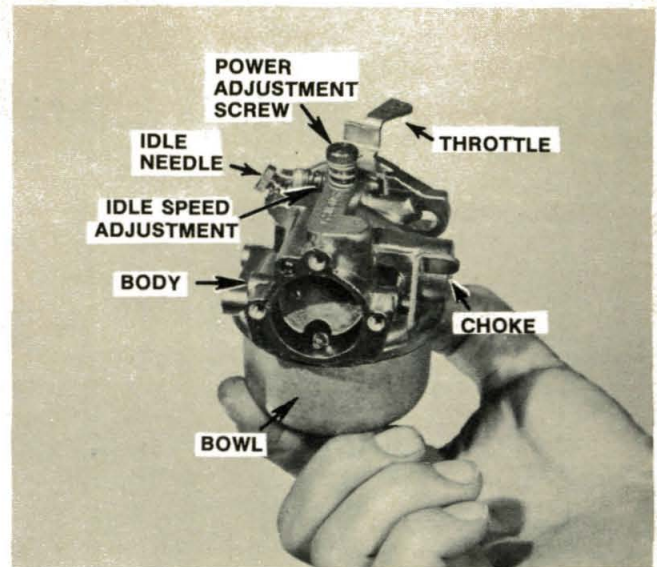

(Photo 4/35) Carburetor for 7HP Kohler engine.

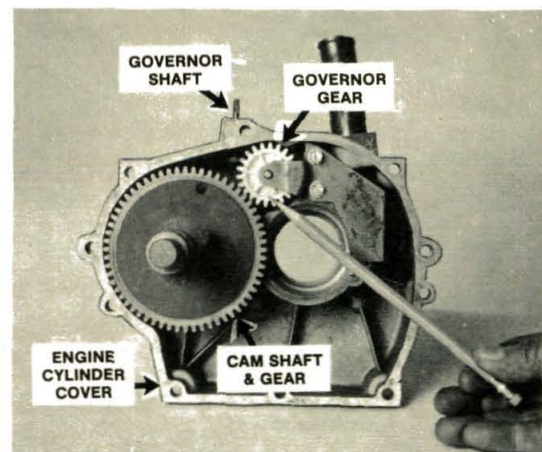

(Photo 4/36) Governor for 6 H.P. engine.

weights spin, the more force they exert against governor spring tension to close the throttle. While the spring works to open the carburetor throttle, the governor lever and linkage tend to close the throttle. The opposing forces find a balance point and keep the engine virtually at a constant speed. Maximum engine R.P.M. is 3600.

ENGINE COOLING

Don't remove any parts of the engine covers or the engine shroud (see Photo 4/1). These covers are designed to direct cooling air from the flywheel over all parts of the engine. If you removed part of these covers your engine would grow hotter not cooler.

Make sure that dirt, grass, leaves and debris are cleaned from the cooling fins on the top and sides regularly.

IMPORTANT: Please remember that your engine Warranty stipulates that anyone (including yourself) other than an Authorized Service Dealer or Distributor for the engine manufacturer, who repairs or alters the engine automatically voids the one year Warranty that comes with your engine on your new Troy-Bilt Roto Tiller.

If you have any difficulty in finding an Authorized Service Dealer or in obtaining Warranty service from such a dealer, or in understanding the Warranty, please write to our Service Department, or call if the need is urgent, so that we may help you.

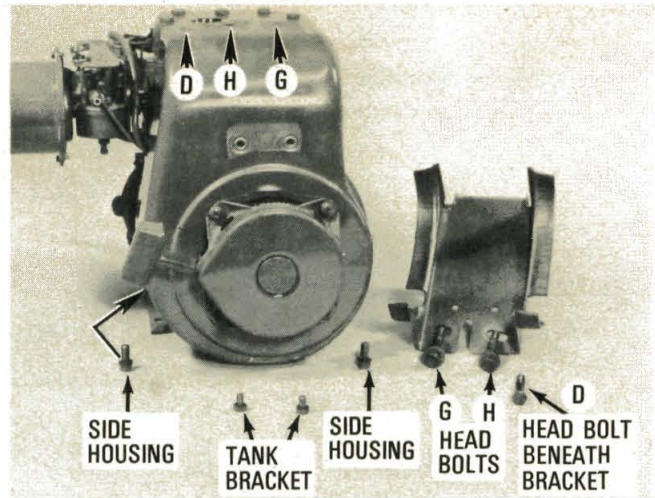

(Photo 4/37) Two head bolts G & H in photo are used to fasten down the fuel tank bracket. Therefore, head bolt D has to be tightened before the bracket is installed. Please follow the bolt tightening sequence as explained under "Head Bolts" and shown in Sketch 4/38.

ENGINE HEAD BOLT TIGHTENING ORDER

The correct sequence for replacing the head bolts is shown in Sketch 4/38. First, thread in bolts labeled A, B, C, D, E and F. Now tighten and torque them (with a torque wrench) to 140-200 inch-lbs. in the same sequence. Make sure D (also shown in Photo 4/37) is properly tightened down because it's covered after you install fuel tank bracket. Install fuel tank bracket with head bolts G and H to 140-200 inch-lbs. Also recheck torque of bolts A, B, C, H, F, E and G. Finally, as shown in Photo 4/37, put the two small bolts in the holes on the bottom of the tank bracket. The 6 HP head bolt order is above.

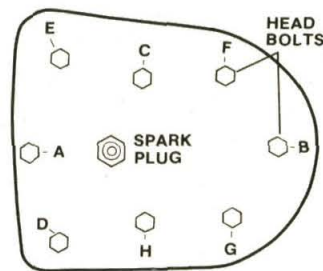

(Sketch 4/38) 6 HP Tecumseh engine head bolt tightening sequence.)

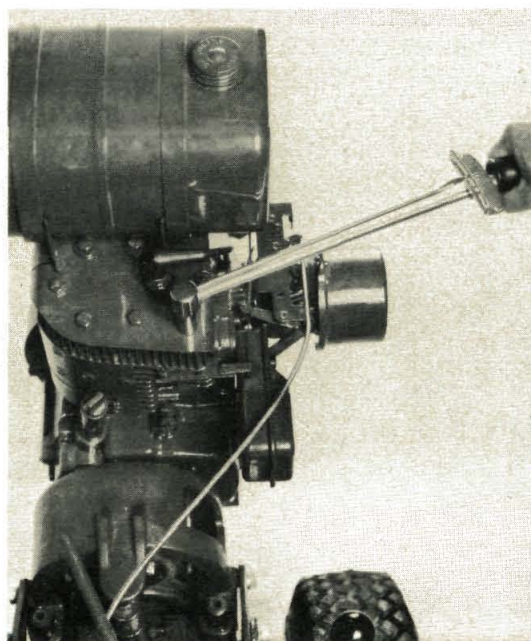

(Photo 4/39) Tightening head bolts on 6 HP engine. See tightening sequence above and in Sketch 4/38.

Tighten the head bolts of your 7HP Kohler engine to 180 - 240 inch-lbs. in the sequence shown in Sketch 4/40. Simply partially tighten the bolts as Numbered 1 through 7 and go back over the same sequence for final tightening. Check head bolts for tightness after 8 to 10 hours of operation on new engines and on engines that have had the head removed or a new gasket installed.

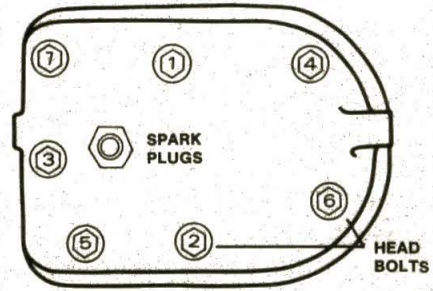

(Sketch 4/40) Head bolt tightening sequence for 7 HP Kohler engine is in order shown in this sketch.

4

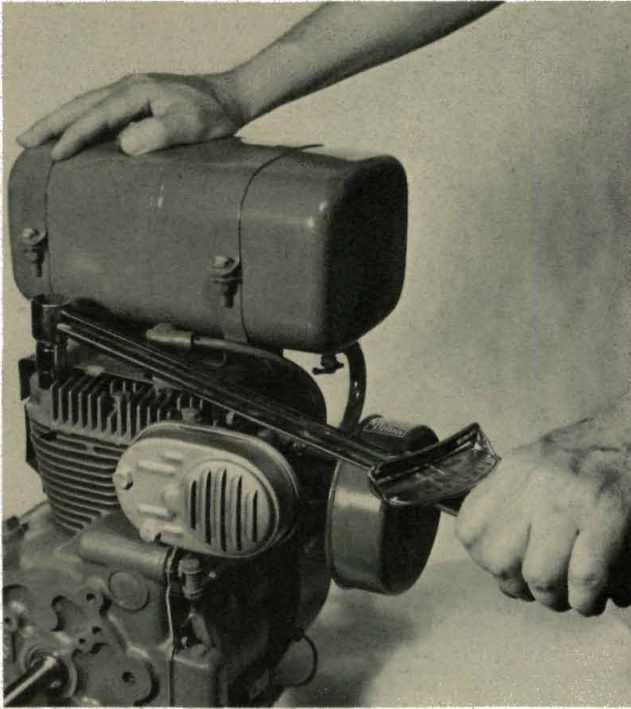

(Photo 4/41) Tightening head bolts on 7HP Kohler with a torque wrench.

IF OIL LEAKS FROM ENGINE

Engine oil leaks may be evidenced by oil found in the bottom well of the motor mount, part number 1002. A leak could be from a cover gasket, a bottom gasket, or from an engine oil seal shown in Photo 4/42. Of course, the engine has to be removed to correct an oil leak from the cover or the seal.

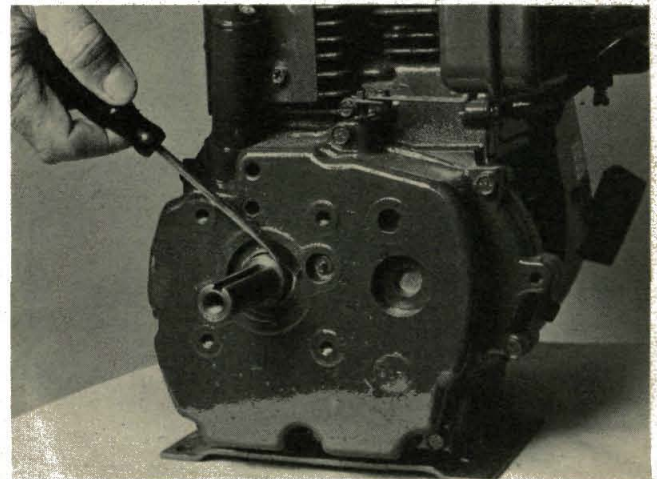

(Photo 4/42) Screwdriver points to 6 HP engine oil seal.

OPERATING THE TILLER

How To Operate Your Troy-Bilt Roto Tiller-Power Composter And Use It In The Garden

Before trying to run your Troy-Bilt Tiller the first time, please make sure that you have taken the following steps:

1. Studied photographs locating controls and compared the photos with the actual controls on your tiller. See pages 28 to 33.
2. Have added #90 or #140 weight gear oil to the tiller transmission and SAE 30 oil rated SE to the engine oil reservoir. See pages 19 and 20.
3. Have familiarized yourself with all of the engine controls. See pages 41 to 47, or pages 48 to 53.
4. Have worked the tiller controls without the engine running and understand what each does.
5. Have read the Safety Precautions in Section 3, pages 37 and 38.

It's a very good idea to take a few moments to operate the tiller without the tines doing any digging. Just run the tiller back and forth and practice movement of the controls for a few moments before you start to till in the garden.

HOW TO OPERATE

(Before Tilling In The Garden)

1. With the depth regulator lowered so the tines are off the ground, set the Forward/Reverse Lever in the Neutral position. As you can see (Photo 5/1), the tines don't touch the ground while the depth adjustment bar is in the "Travel Position."
2. Push the Wheel Speed Shift Lever down into the low speed position (see Photo 5/2) while you roll the tiller back and forth a few inches to help get the Wheel Speed Shift Lever into gear.
3. Start the engine. (See Section 4, pages 47 and 52 for starting instructions for your own engine.)

4. Now, if you push the Forward/Neutral/Reverse Lever down into Forward position, the tiller will start moving along the ground by its powered wheels. See Photo 5/3.

5. To stop the tines and the wheels from turning, just lift or tap the Forward/Neutral/Reverse Lever into Neutral—see Photo 5/4. Your tiller is in Neutral when the roller is anywhere on the flat vertical surface of the block, just so long as you are not holding the lever up in the Reverse position.



(Photo 5/1) Travel position of tines



(Photo 5/2) Wheel speed select lever

Naturally you should not lower the tines with the depth regulator until you are prepared to dig up the soil, so do your practice with the depth regulator set in the "travel position"—tines off the ground.

TO TURN AROUND

When you want to turn around in practice, slow the engine throttle down then lift the handlebars up high enough to find the balance point between the weight of the engine up front and the weight of the tines in the rear.

When you have found this balance, swing the handlebars in the direction you wish to turn around and follow along with your feet. (Be careful to keep your feet and legs away from the revolving tines.) See Photo 5/5. Let the powered wheels do most of the turning and you just guide it. Also see Photos 5/6A, B, C and D.

When you are pointing in the direction you want to go, lower the tines back to "travel" position by lowering the handlebars. Put the Forward/Reverse Lever in Neutral long enough to get properly lined up with the imaginary row you are tilling, and then put the lever back into Forward.

STOPPING THE TILLER AND ENGINE

1. Lift the revolving tines out of the ground and move the Forward/Reverse Lever into Neutral. See Photo 5/4.

To get Neutral—if you are going forward, move the lever up—if you are in reverse, let go of the lever.

2. Slow engine speed down to idle.

3. After a few minutes of idling shut engine off. To shut off the 6 horse power Tecumseh engine,



(Photo 5/3) Forward/Reverse Lever



(Photo 5/4) Use Forward/Reverse Lever to stop.



(Photo 5/5) Turning around

merely push the throttle lever all the way forward (to right) until it engages the shutoff clip. For the Kohler engine, push in the Stop Button on the engine and hold it in.

PLEASE REMEMBER TO READ the complete turning around instructions on this page before you operate your tiller in the garden.

TILLING IN THE GARDEN

When you start to till in the garden, remember to take it easy. Use the *low* wheel speed for breaking in new ground. Do not try to take too deep a cut in the first pass through sod or hard ground, or soil that has not been tilled for several months or years. Go over the same path twice in the initial row, then lap $\frac{1}{2}$ on succeeding passes. When tilling under sod or rows of corn, if there is even the slightest slope, make the first passes uphill. In most soils, it's best to start out at the second or third notch of the depth regulator to break through the upper surfaces of the soil. An alternate method is to set the depth regulator as deep as you can without the tiller "jumping" when it comes to hard spots or medium size stones.

Now position the tiller at the beginning of a row of your garden that you want to till. Have the depth regulator at the second or third notch, put the Forward/Reverse Lever in the Neutral position, start the engine and roll the tiller back and forth a few inches until you are able to push the Wheel Speed Shift Lever into low gear. Then you are ready to start tilling in the garden.

Push *down* on the Forward/Neutral/Reverse Lever and start tilling. Just let the wheels pull the machine along as the tines do the digging. Don't lean on the handlebars because this takes weight off the front of the wheels, reduces traction and causes the tines to attempt to propel the tiller instead of just digging.

TURNING AROUND

When you reach the end of the first row, slow the engine down with the throttle and lift the handlebars to raise the tines out of the ground. Then shift the Forward/Reverse Lever into Neutral Position. Tilt the Troy-Bilt forward far enough to gain perfect balance before starting your turn as shown in Photo 5/6A. If there's any secret to turning, it's right here. Raise

the handlebars high enough so that the weight of the engine out front balances the weight of the tines in the rear. Tines are usually a foot and a half off the ground at this point.

To make the turn, *shift the clutch lever into Forward position*—holding the handlebars up to balance the weight—and *push the handlebars to the right (or left)* so that the tiller swings around in the direction you wish to turn (pivoting it around). See Photo 5/6B and Photo 5/6C. It should take very little effort to swing the tiller around easily as the wheels drive your Troy-Bilt and do most of the turning. (It could prove more difficult on uneven terrain when turning in the uphill direction.)

Using reverse tiller motion, (in low speed) as shown in Photo 5/6D, permits you to turn within a 3-foot radius in close quarters. Do so, by keeping handlebars high in air, balancing tiller weight, and use Forward/Neutral/Reverse Lever to back up briefly. This will allow you more room to go forward and continue your swing around. Caution: Don't let yourself be backed into a solid obstruction like a tree, garage door, or fence.

Make sure that you have the depth regulator set at the depth you want and the tines are in line with the path you wish to till. It is best in tilling sod to overlap each row about ten inches until you have the garden well busted up and the soil pulverized.

As you can see by the photos and after you have tried it in the garden, turning your Troy-Bilt Horse Model around is simple and easily done once you get used to controlling the balance on the pivot point, operating the shift lever and letting the power driven wheels do the work.

Both wheels on your Troy-Bilt Tiller turn around at the same rate of speed because your tiller is designed with a solid axle providing equal power to both wheels. This makes it possible for the wheels to hold the tiller back while the tines are digging—one of the most valuable features of your Troy-Bilt Roto Tiller-Power Composter. The Troy-Bilt Horse Model's transmission is simpler, less expensive initially and less costly to maintain than a separate tine clutch and transmission, or a differential or transaxle for differences in wheel turning speeds.



(Photo 5/6A) Raise handlebars to start turn.



(Photo 5/6C) Let wheels drive tiller in turns.



(Photo 5/6B) Swing handlebars around.



(Photo 5/6D) Use reverse in tight areas.

TILLING PATTERNS

Please see Sketch 5/7 on page 60 of this section which will give you a helpful pattern that you can follow to till a new garden. By going up and down rows and overlapping each time, you will be sure to bust up all the soil with the minimum amount of effort. And, by making a second pass in a direction 90° across all of your previous passes, you will really pulverize the entire garden area with your Troy-Bilt Tiller.

If you don't have enough width in your garden to till lengthwise and then crosswise, here is a method of overlapping that will make sure that all of the soil is well busted up for planting. For tilling long, narrow strips, overlap the second, third and fourth passes half a tiller width over the previously tilled path, then overlap one-fourth a tiller width on successive passes back over the freshly tilled ground. This will assure you of thoroughly breaking up the ground.

Later when you have growing crops, you can see how the diagram on cultivating (Sketch 5/7) shows a good method to most efficiently cultivate with your Troy-Bilt Tiller while getting the maximum usage out of your garden space. Keeping crop rows 30 to 36 inches apart on stem crops and up to 48 inches apart on bushier crops, makes it easier to use the tiller for cultivation in high speed without damaging the crops themselves.

Remember, in tilling it is extremely difficult to get down four or five inches on the first pass through and till previously unworked soil with any medium sized or smaller tiller—even with a rear-end tiller with power wheels like your Troy-Bilt Horse Model. If you use an overlapping pattern, take it easy and let the tiller do the work, tilling will become incredibly easy. Later, when your garden soil is greatly enriched by adding organic matter, you will be able to till surprisingly deep on the very first pass.

TILLING NARROW STRIPS



OVERLAP 1/2, THEN 1/4.

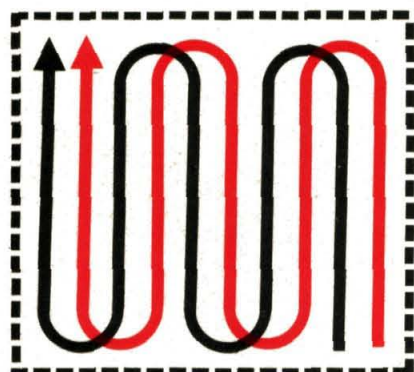

AREA TILLING
PREVIOUSLY WORKED SOIL

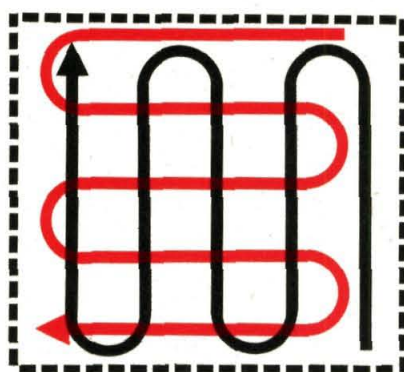

AREA TILLING
UNPLOWED GROUND

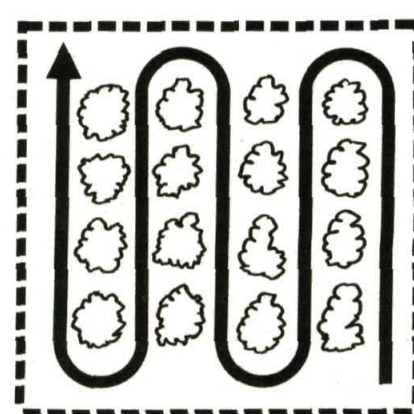

CULTIVATING

(Sketch 5/7)

HERE'S A HELPFUL TIP

Whenever you are tilling vertically on the slightest slope, try making the first pass uphill. Your tiller will dig in much more deeply going uphill than it will downhill. This is especially helpful when tilling under sod or cornstalks. In this situation, make your first pass uphill and you'll be surprised how much better the results will be.

DON'T MAKE FOOTPRINTS

When you are making passes in a garden section at the desired depth, walk alongside the tiller on the side that is not yet finished. You can easily guide the tiller with one hand, leaving no footprints in the path that you have just tilled.

Eliminating footprints contributes much more than just good appearance to your garden. It aids in preventing soil erosion and avoids "planting" unwanted weed seeds and plants right back in your garden bed.

UNWINDING TINES

Wherever you have a high growth of rye grass that is dried out, stringy stalks, or hardened vines, there will be occasions where there is some tolerable tangling of crop residues among the tines. When this happens, it's very useful to lift the tines out of the soil, stop your forward progress by shifting into neutral, and put the tiller into reverse for a few feet. This will reverse the direction of the tines' motion and unwind a good deal of the debris. Then you can shift into forward and go on tilling again.

It also helps a great deal under such conditions to set the depth regulator adjustment deep enough to get maximum "chopping" action as the tines chop the stalks against the ground. The depth depends upon how deep you tilled the ground before and also on the conditions of the soil.

With experience you will find that it is not

BrentChalmers.com

necessary to remove entirely all of the crop residue that might wind around the tines during tilling. Naturally, you don't let it get so large that it builds up to a point where it would choke off the action of the tines. Before it does this, try reversing the tiller to unwind and reduce the amount of tangling. And, if necessary, stop the machine, put the Forward/Reverse Lever in Neutral.

WARNING: For safety's sake, stop the engine entirely before unwinding the tangled material by hand.

Under such conditions, a small pocket knife, or a linoleum knife, can be helpful in cutting loose some of the tangled material faster. You will find, with your Troy-Bilt Tiller, that there is a very minimal need to go to this much trouble to avoid tangling. Obviously, it can happen on occasion with some crops and certain soil and weather conditions.

BOLO TINES

Bolo tines are standard equipment on your Horse Model Tiller (see Photo 5/8). They are truly the best *all-purpose* tines for all soil conditions. They are used for tilling sod, weeds, cover crops, composted material, as well as for regular tilling and cultivating. They will till to a depth of 6 to 8 inches, or more.

Bolo tines just about eliminate all but a small, bearable amount of tangling.

Bolo tines require two holders and a set of 16 tines in all. There are left and right handed tines alternated on both sides of the tiller to give you the widest and most completely busted up path in your soil that's possible with your tiller.

The most important thing to realize about bolo tines is that they are by far the most effective in turning under cover crops. Bolo tines permit you to take advantage of the Troy-Bilt's ability to turn green cover crops with all of their valuable minerals and nutrients right back into the soil as you till your garden.

Bolo tines are also excellent tines for shallow cultivation at High or Low speed.

POINTED PICK TINES

Pointed Pick tines are ideal for hard or rocky

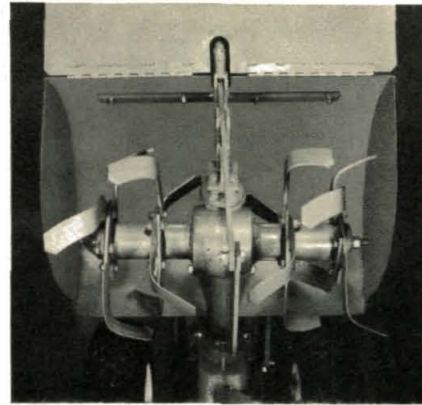

(Photo 5/8) *BOLO TINES*—The best general purpose tines for all soil conditions. Best for tilling under cover crops.

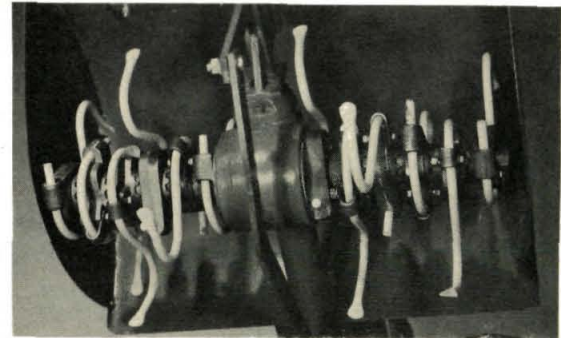

(Photo 5/9) *POINTED PICK TINES*—For hard-packed or very rocky soil.

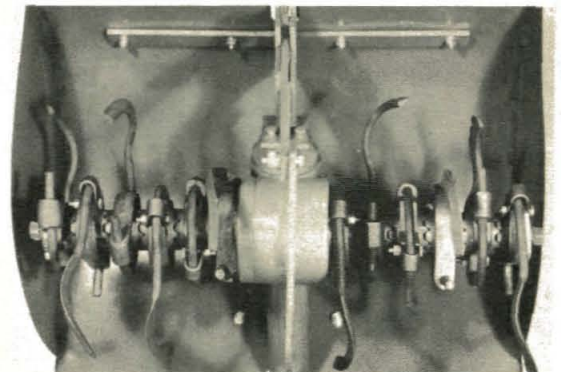

(Photo 5/10) *CULTIVATING TINES*—For shallow tilling and close cultivating without root damage.

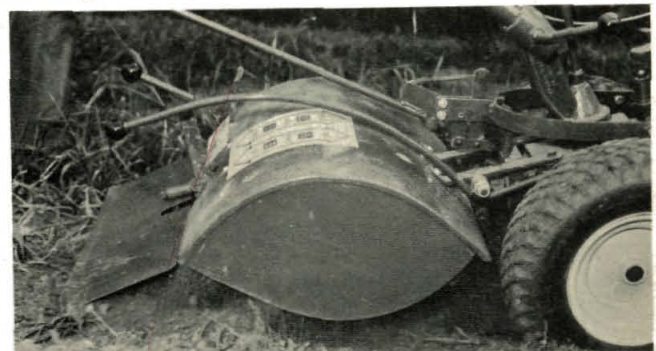

(Photo 5/11) *Match speed to job.*

5

ground. (See Photo 5/9.) They tend to clog up badly in sod or any tall or lengthy vegetation and are best used in clear ground only. They will till 6 to 8 inches deep.

Pick tines are especially good where you have hard clay and ground that has not been tilled for several years. Although Bolo tines will normally till any ground that you run up against, they occasionally will require several passes over the same very hard, rocky ground to make much headway. Using Pick tines in hard packed soil will often break up the soil in just a few passes.

Naturally, as you cultivate your garden and put back more organic material into the soil—growing more vegetation for the tiller to chop up, you will reach a point where you have improved your soil conditions so much that the early advantages of Pick tines will give way to the all-around performance of Bolo tines.

CULTIVATING TINES

These specialized tines (see Photo 5/10) are best for cultivation, which should be only one or two inches deep to avoid damage to the roots of plants. However, they will till as deep as 5 inches and disturb less soil than will Bolo tines.

They are an ideal choice wherever you wish to cultivate between rows near shallow-rooted crops, and for berries, vineyards, orchards and shrub or tree nurseries. In fact, many professional growers prefer these tines for cultivating.

MATCHING WHEEL AND TINE SPEEDS TO PARTICULAR JOBS

With a little experimenting, you will soon be able to find the proper depth, wheel and tine speed that is just right for the piece of soil you are working on. (See Photo 5/11). What this means is:

1. You advance the throttle lever on the handlebars to keep the engine running at a power level that is adequate to do the job.
2. You have the depth regulator set in a notch

that is not so deep that it causes the engine to labor or causes the tiller to jump.

3. That you have the tines turning over fast enough to really bust up the soil with a minimum number of passes.

When your Troy-Bilt is working in this manner, you can hear if the engine is not laboring very hard and see that the tines are moving well and breaking up the dirt to small friable granules. At the proper match of wheel and tine speeds, you will get the job done just as quickly, more effectively and will achieve results that are better and more satisfying. See Photo 5/12.

TILLING VERTICALLY ON SLOPES

If you garden on a slope, your Troy-Bilt Roto Tiller Power-Composter can be the greatest benefit to you if you are able to plant vertical rows up and down the slope. You can till up the slope in high gear. In soft soil or weeds, you may have to lift the handlebars up slightly as you go uphill. Till uphill on the first pass. It will do a better job than going downhill. Till downhill in low gear. *Never shift wheel speed gears if the tiller is heading up or down a slope. See Safety Rule No. B.7 on page 38.* The powered wheels of the Troy-Bilt will pull the tiller up the hill to do your digging and will also hold the tiller back while you go downhill to prevent the tiller from going too fast. See Photo 5/13 and Photo 5/14.

Tilling vertically on a slope will permit you to prepare the entire area for your seedbed as well as provide enough room between rows so that you can cultivate between the rows during the growing season. Surprisingly enough, growing a garden vertically on a slope does not have to involve much of a problem with soil erosion, as long as you have put in enough organic material to improve the moisture holding ability of your soil and do not leave footprints or wheelmarks. Soil in this condition will be broken up enough to prevent packing, and will be held together well enough by those organic materials so that it will absorb water.

Tilling vertically up and down a slope allows you to make tilling passes while walking alongside the tiller, with one hand controlling the tiller, at the same time thereby eliminating troublesome wheelmarks and footprints that

are likely to cause erosion and gullies on a slope.

Being able to till vertically up and down the slope will also permit you to constantly and continuously improve the soil's water absorption and drainage from season-to-season, by tilling under weeds, mulches, residues and green manure cover crops as often as is possible. The more organic material you are able to till into a slope, the more likely you are to be able to prevent hard packed soil conditions from occurring. This, of course, will eventually virtually eliminate one source of erosion (water runoff from packed soil).

Tilling uphill and downhill will enable you to cultivate between crop rows with your tiller rather than hand cultivation likely to be required if you terrace across a slope.

TILLING ACROSS SLOPES

Whenever a slope is extremely steep or too short for vertical tilling, you may decide that you simply must till across the slope laterally. First make sure that the slope is *not too steep to till safely at all*. The best way to achieve good results tilling across the slope is to create terraces for your garden. See Photo 5/15.

In three or four passes, the Troy-Bilt Roto Tiller-Power Composter can carve out a flat and wide enough terrace for planting. Start to terrace on the top of the slope and work down. Each succeeding lower terrace is started by walking on the edge of the terrace previously prepared uphill of it. Make sure that you don't till the last 6 to 8 inches of the outer edge of the terrace. The tiller will cover this edge up with soil, but don't till the edge. Keeping the soil underneath the edge unbroken will prevent terraces from breaking apart and washing downhill.

Terraces should be formed by tilling a swath three to four feet wide. This width on a slope will mean that there will not be enough room to use the tiller for cultivating. You'll be able to prepare a seedbed for two rows of plants with the tiller and till under crop residues, but you'll have to cultivate by hand by walking along the inner edge of the terrace below.

Although your tiller could form a terrace five



(Photo 5/12) *Satisfying Tilling Results.*



(Photo 5/13) *Vertical Tilling on Slope—Tilling uphill on a slope with row markers staked out. It saves time and effort and builds up your soil by power composting and cultivation.*



(Photo 5/14) *Vertical Tilling on Slope—Tilling downhill and burying sod in one easy step.*



(Photo 5/15) *Tilling Across a Slope—Making terraces across a slope won't leave you room to cultivate with your tiller when crops are grown.*

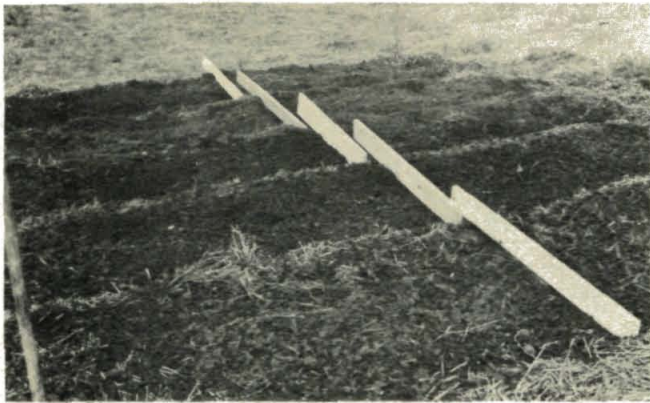

(Photo 5/16) Terraces formed by tilling on a slope are about three feet wide.

TILLING ACROSS SLOPES WITHOUT TERRACES

Tilling across the slope without terraces is not the way we recommend, but it can be done in the following manner. Begin at the top of the slope and overlap half of each tilled path, **always keeping the uphill wheel in the soft, newly tilled soil.** Doing so will help you keep the tiller more stable across a relatively steep slope.

Before trying to till in this manner, or creating terraces across a slope, please think it over carefully and see if it isn't possible to till vertically up and down the slope.

5

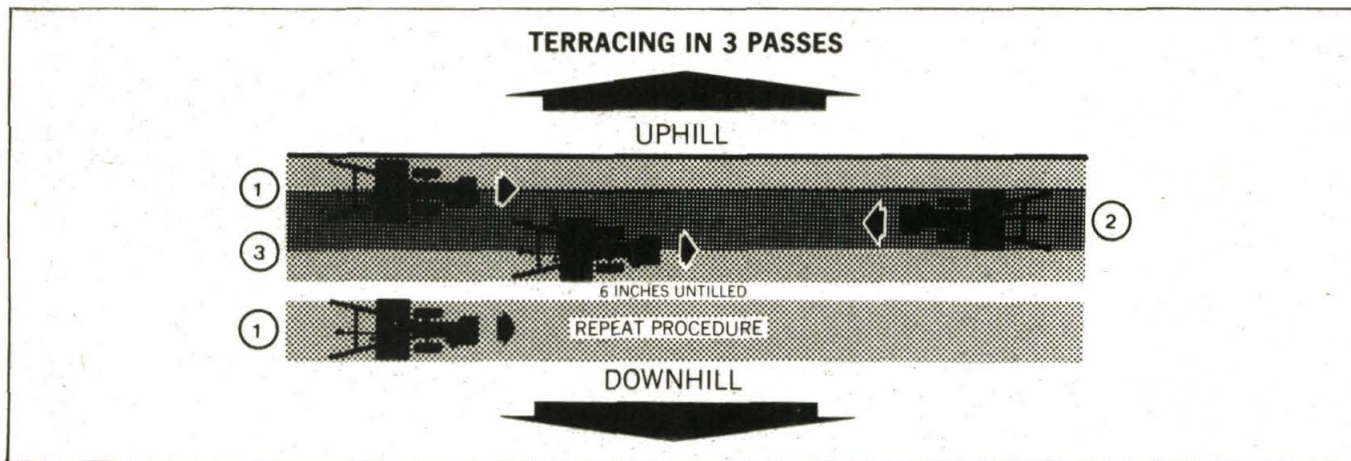

(Sketch 5/17) Creating a terrace in three passes.

feet or more wide which would leave enough room for cultivating with the tiller, digging to this depth on a steep slope would likely mean that you would be growing plants in subsoil since the inner edges of the terrace would be cut more deeply into the hill. Thus, the need to hand-maintain narrower terraces across the slope after the seedbed has been prepared with a Troy-Bilt Tiller, makes it much more desirable to create a garden vertically up and down a slope, if it is at all possible.

MAKING TERRACES IN 3 TO 5 PASSES

Here's how to go about making your terraces across a hillside. Till across the inside edge of the terrace and turn around, then, come back and retill the same ground (because you can't overlap on the first pass of each terrace). Then, overlap one half a tiller's width (10 inches) and go back in the other direction. When you reach the end of the terrace, turn around and go back, overlapping one half a tiller's width again. Remember, leave the last 6 inches or more untilled. See Photo 5/16, Sketch 5/17 and Photo 5/18.



(Photo 5/18) Use of a furrower attachment is an ideal method of creating a deep furrow on the inside portion of a terrace to speed up transplanting of young tomato or pepper plants and potatoes.

A furrowing attachment on your Troy-Bilt Tiller can be very useful to you in making terraces. The furrower can be quickly mounted and removed at will. It creates a nice deep furrow on the inside portion of the terrace and is an excellent tool for planting and transplanting

tomatoes and other crops. Make terraces 3 feet wide, with two rows of plants for each terrace. Or, you may wish to use your Dozer Blade to make terraces.

UPHILL TILLING NOTE

IMPORTANT: Always make sure that you check your engine oil level every day that you use your tiller and bring the oil up to the "Full" mark of the dipstick. But, it is especially important while tilling up and down a slope.

When you are tilling at the deepest setting of the depth regulator and going up a steep hill, you seriously increase the incline of the engine on the tiller. As you know, the engine's operation depends upon its ability to splash oil to its moving parts to properly lubricate itself and prevent overheating from friction, or bearing surfaces from "burning out" from lack of oil. Tilling deep enough for the cover flap to flatten out the soil while going uphill will seriously increase the engine's incline, so the oil will slant away from its normal position. The engine's oil dipper will not be able to reach it unless the oil level is kept properly up close to the "Full" mark. Keeping engine oil *all the way up to the "Full" mark on the dipstick while tilling uphill is absolutely necessary.*

When you are tilling across a hill or downhill, you need to exercise normal precautions about engine oil levels, but need no more concern than when tilling on level ground.

Tilling uphill in high gear and lifting up gently on the handlebars prevents the tiller from digging in too deeply and keeps the engine's slope from reaching an extreme angle. So, both will help to keep oil up where it will provide the desired lubrication. Keeping the length of time spent in uphill tilling at a minimum will also work in your favor if you level out the engine base in between passes. This will bring the oil level back to a normal situation and make a full supply available for lubrication momentarily.

SPECIAL TROY-BILT METHODS FOR EASIER, MORE ENJOYABLE GARDENING

Your Troy-Bilt Roto Tiller-Power Composter with tines in the rear and tractor powered wheels is actually two machines in one. First of all, it's a superior rotary tiller and secondly,



(Photo 5/19) Hood aids in pulverizing.



(Photo 5/20) Crop residues enrich soil.

it is an extremely efficient compost-shredder-chopper that will easily cut up all garden leftovers right in the garden plot and turn your garden into one big compost pile.

The fact that the Troy-Bilt has tines in the rear and its wheels are power driven is the secret. The tines are separately geared and revolve at a speed $13\frac{1}{2}$ times faster than the wheels. See Sketch on page 12. These tine-speed-to-wheel speed ratios are for low gear tilling at a full throttle engine speed (3,000 R.P.M.). The $13\frac{1}{2}$ to 1 ratio will do a magnificent job of busting up the soil and chopping up crops and crop residues to provide compost material for your garden. At this ratio, the tines break up the soil evenly and thoroughly, turning and tilling it into a fine, soft texture.

The safety hood further helps groundbreaking as sod, soil and vegetation are thrown up against it by the revolving tines. The hood traps this matter momentarily and allows the tines to further pulverize it and put it back in the garden—see Photos 5/11 and 5/19.

As a compost shredder-chopper, your tiller chops up and shreds the usual vegetation in its path, even cornstalks, and in successive passes buries this material in the ground where it decomposes and releases the nutrients to your garden. Some of the more difficult crops may take several passes to be fully buried. But, most crops will be chopped, shredded and buried all in one pass through the garden. The Troy-Bilt's unique combination of tilling and shredding allows the gardener to enrich the soil far beyond his ability to do so by hand. See Photo 5/20.

One of the keys to the Troy-Bilt's design success is its powered wheels. These large wheels are at the perfect balance point between the engine up front and the tines in the rear. See Photo 5/21. Power is supplied directly to the wheels so that they move the tiller forward deliberately, evenly and gradually. Since the wheels take care of all the weight in forward motion, the tines are free to revolve at a much faster, separately controlled speed. With the Bolo tines revolving many times faster than the wheels, the tines can chop up, shred and bury organic material during tilling in one simple step.

Vegetation that isn't chopped up and that does tangle can easily be released by lifting the handle and the tines off the ground and shifting into reverse motion. The free-revolving tines unwind the bulk of the tangling quickly.

NO FOOTPRINTS OR WHEELMARKS

Here's why you don't want footprints and wheelmarks. They replant weed seed and ruin the fine dust mulch that tilling creates when you break up the surface soil. The compacted soil permits evaporation to continue as before tilling. Wheelmarks also form gullies which, during heavy rains, undermine plants and wash away top soil. See Photo 5/22. Walking beside the rear mounted tines of a Troy-Bilt and guiding it with one hand eliminates both of these problems. See Photo 5/23.

Because the wheels are out in front of the tines, you can maneuver the tiller in tight spots and till closer to plants without danger of doing damage. Also, you can turn the tiller around using the wheels as a pivot. Moreover, the vertical sides of the hood help to stop soil from splattering on plants or flowers as you run close to a row.



(Photo 5/21) *The wheel axle serves as a pivot point to balance the weight of the tines in the rear against the weight of the engine up front.*



(Photo 5/22) *Don't leave these marks.*



(Photo 5/23) *Use one hand.*



(Photo 5/24) *In soil well built up with organic matter and large stones removed, your Troy-Bilt will till a smooth seedbed quite easily as you walk alongside to avoid making footprints.*

UNIFORM TILLING DEPTH

Your tiller will not leave large clumps intact in your garden, if the soil is dry (but will if the soil is very wet). It won't porpoise along tilling at uneven depths, first deep, then shallow if you don't try to go too deep in too few passes. With the depth control lever, uniform tilling depth can be adjusted instantly. You have a selection of any of eight positions to choose. The tiller leaves a perfectly smooth and finely tilled path.

BUILDUP OF ORGANIC MATTER

The secret of gardening success has always been chopping and mixing into your soil all of the organic matter you can get. See Photo 5/25. Nature has been recycling and adding organic matter (any tissue living or once alive) to the soil for millions of years. The natural cycle is completed when things grow out of the soil by tapping soil nutrients, flourish, die, return to the earth's surface to decompose with the help of earthworms and other soil life, and then release nutrients back into the soil as a fresh supply of transplant food.

Many gardeners overlook these simple natural cycles that have been taking place all about them all the time. Although chemical fertilizers can release enormous quantities of nutrients at one time, they don't add to the soil's ability to avoid compaction and retain moisture.

On the other hand, organic matter acts as a natural fertilizer, helps make valuable humus, and actually creates rich new top soil when fully decomposed. It does other important things for the soil, such as retaining moisture, breaking up hard clay, and making soil more friable and improving air circulation.

EARTHWORMS CAN HELP YOUR SOIL

Crops grow poorly on compact soil. To produce bountiful crops, soil needs a supply of moisture, adequate air spaces in the soil for development of roots, and availability of nutrients.

The worms' passageways also provide the airspaces needed for root development in what was formerly compact soil and they provide oxygen for other soil life. Earthworms themselves require both organic debris and mineral



(Photo 5/25) Organic matter in soil.



(Photo 5/26) Knee-high cover crop of buckwheat tilled into the soil adds large amounts of valuable organic matter.



(Photo 5/27) After harvest, tilling under the crop residue adds nutrients to the soil.



(Photo 5/28) Leaves contain trace minerals that the tree's roots draw up from deep down in the soil. To release these minerals and other nutrients, till them into soil.

soil for their food. The nutrients they don't need for themselves, they leave behind in their castings.

Earthworms can be extremely helpful in providing passageways throughout the topsoil and down into the subsoil through which surface water can travel and get down into the soil rather than simply running off. These passageways of earthworms, lined with their castings, spread rich nutrients throughout the soil. Most often, these rich nutrients have been dragged down into the soil from the surface or up from the subsoil by the worms.

What this all means is that earthworms can be marvelously beneficial in improving and maintaining the best soil conditions for good crop growth. By themselves, they won't make a flourishing garden out of barren wasteland. But, they will be of great assistance in your efforts to improve poor clay soil or mixtures of clay and fine grain sand, if you provide the worms with some organic material and moisture and the nutrients that are lacking.

SOURCES OF ORGANIC MATTER

The most common sources of organic matter for home gardeners, are leaves, old hay, animal manures of all kinds, compost, grass clippings, weeds, crop residues and green manure crops. A garden with plenty of decaying organic matter has so many things going for it that it can't help but be bountiful. Thousands of Troy-Bilt owners are now having tremendous results because they can spread huge quantities of organic material over their gardens, chop them up, and till them under—in one easy operation. This is a task that can only be accomplished effectively with a rear-end tiller like your Troy-Bilt.

POWER COMPOSTING

Compost piles are a tradition with most gardeners. The finished product does wonders. However, compost piles take a lot of time and effort to produce relatively little quantities. A large pile of leaves will reduce down to a few pounds of leaf mold. You can work for long hours of collecting, layering, watering and turning over a pile in the course of a year, and still yield barely enough to sprinkle over your garden.

The Troy-Bilt Tiller makes it possible to create ten times as much compost in one-tenth of the time. We call it "power composting" because the Troy-Bilt can actually chop, shred and bury organic materials directly into the soil. Surrounded by earthworms and all the other forms of life which digest and break down these materials, "compost" and new humus is manufactured so much faster.

It is absolutely essential that a garden be fed something if it is to be bountiful year after year in the same location. You must replenish the plant nutrients, primarily nitrogen, phosphorus, potassium—that you took away from the soil in the form of harvested fruits and vegetables. The first place to begin with is the garden residues, especially turning them under while they are still leafy, green and tender. They will furnish much more good food for the earthworms and other soil life.

TURN IN GREEN CROPS EARLY

Turn crop residues under as soon as they finish bearing instead of letting them go to seed. The sooner this is done, the better for your garden. Tender, green matter tills in more easily and decomposes faster. See Photo 5/29.

Other sources of good organic material are sawdust, woodchips, animal manures of various kinds, alfalfa, hay, straw, grass clippings, seaweed, leaf mold, and shells. There are several other organic fertilizing agents to be found as refuse near certain industries, such as tobacco stems, sludge, dry fish scraps, and granite dust.



(Photo 5/29) Tilling crop residues.

COVER CROPS

It makes sense to add more valuable organic matter to your garden with a *green manure cover crop*. See Photo 5/30. Why not keep

your garden green and covered throughout the winter and early spring with a cover crop. Cover crops can also be grown in temporarily idle parts of your garden during the growing season to provide nitrogen-rich matter.

It's so easy for you with your Troy-Bilt to shred and bury that good green matter back into the ground when the cover crop has grown. Growing and tilling under a cover crop is called "green manuring." Its nitrogen-packed foliage has great fertilizing value, perhaps more than many animal manures from which elements leach away.

Green manures are generally cheaper than animal manures and avoid awkward transportation. Of course, **a cover crop also performs all of the same valuable jobs of heavy mulch; preventing erosion from winds and storms, keeping weeds from going to seed in the fall, retarding ground freezing.** In addition, **cover crops hold topsoil together through spring thaws and retrieve replacement minerals from the subsoil.**

"Green manuring" is an outstanding way to make sure that your garden gets enough organic matter. A cover crop produces green manure by the truck load. Compost piles only do it by the wheelbarrow load. Photo 5/31 at right illustrates a lush growth of rye grass that was planted the previous fall. It was two feet high in the spring. The annual rye grass, as opposed to perennial rye grass, is especially good since the root systems also die and decompose as plant food.

Your Troy-Bilt Roto Tiller-Power Composter can easily chop up and turn under a cover crop of kale such as the one shown in Photo 5/32. This crop surprisingly survived the winter and provided tasty early spring eating.

After a cover crop is turned into the soil by your Troy-Bilt Tiller, it is best to allow 10 days for thorough decomposition and then till once more before planting in a smooth seedbed. Green manure crops that grow too tall can also be mowed before tilling to yield a fresh supply of mulch material. Many are grown just for that reason. After mowing the crop, till the remaining stubble and roots back into the soil.



(Photo 5/30) Rye grass cover crop.



(Photo 5/31) Tilling under rye grass.



(Photo 5/32) Kale is a good cover crop.

USE OF BUCKWHEAT TO PREPARE FOR A NEW GARDEN

Before you start a new garden area, use of cover crops should be high on your list of preparations and plans. Cover crops can do wonders for your soil by providing nutrients and clearing out weeds before you start your new garden.

If you have a weed or grass problem, two successive cover crops of buckwheat will eliminate nearly all of the weeds while adding

nutrients to your soil. Because buckwheat grows so fast, you can plant one crop on your planned garden area in late May (in northern climates) and till it under when the buckwheat is about 12 to 14 inches high. While the growth is still a luscious green, this height is easiest to handle because it eliminates most tangling. Also, it will be readily digested by earthworms and soil life.

After you have tilled in the first crop of buckwheat, you can sow a second crop of it immediately. Buckwheat can germinate in as little as five days. Sometime in August, when the second crop is again 12 to 14 inches tall, till it under. Then, plant either annuals or perennials for a cover crop to carry through the winter, depending upon your need.

5

The third crop you plant will protect your soil from erosion over the winter. Remember, you can plant cover crops in northern climates into September. Just decide when and what you are going to place in the garden area the next year.

If you are going to plant the next year, it is best to plan an annual cover crop to carry through the winter. A cover crop such as annual rye grass, which will grow to about 15 to 20 inches high by winter, will protect the soil, hold an even temperature in the ground and enable earthworms and other organisms in the soil to work throughout the winter. The annual rye grass will be completely devoured by soil life when the snow melts in the spring and you can plant your early garden.

If you are going to plant later crops the next year, such as corn, squash, melons, or beans, you can plant a perennial cover crop. You might want to till under a perennial crop of winter rye or wheat in May; or let it grow until late May, then cut it down for mulch elsewhere and till under the remaining stubble for its nutritional value to your soil.

MOST COMMON KINDS OF COVER CROPS

There is a large variety of good cover crops such as: *grasses* like winter rye, annual and perennial; *grains* like buckwheat; *edible vegetables* like kale; and *legumes* (plants that have the ability to fix nitrogen from the air like alfalfa and soybeans). It would be best to consult your local county agent as to which crop would most benefit your particular soil. Here are some

other common crops used:

cowpeas	lespedeza	rye
oats	red clover	barley
soybeans	common- vetch	millet

MULCH

To keep down weeds between rows in the garden, mulches are generally applied in the mid-growing season, after the soil has been thoroughly warmed up and has been well cultivated. See Photo 5/33. At that time, a heavy mulch of hay, old straw, grass clippings or other dense organic materials is used to control the weeds. Some people even use newspapers, and others use rolls of plastic "mulch." Newspapers take quite a while to break down and decay and the plastic does not break down at all, so it contributes nothing to the garden. During a cold, wet year, it's best not to mulch at all.



(Photo 5/33) A heavy mulch of hay and grass clippings can be easily moved to the garden in a large wheeled cart and distributed between crop rows with a fork.

When a layer of mulch breaks down and the level gets low, it should be covered up once again with more mulch material. You can do this once or twice more until the crop is ready for harvest. Then, you can till the crop and mulch into the soil together in one pass with the tiller.

You don't have to rake or shred mulch if you use your Troy-Bilt Tiller to till it right into the soil. If you have grown some extra tall cover crops such as rye grass that got too high before you could till it under as green manure, you can cut the rye grass down and spread it as mulch elsewhere in the garden.



(Photo 5/34) *Mulch is placed in between rows of strawberry plants. Next year, new plants will be grown in the rows where the mulch has been.*



(Photo 5/36) *Mulch can be moved to the garden in a cart and hand carried to place it carefully around tomato plants and other crops.*



(Photo 5/35) *The dense covering of mulch will provide shade, keep the surface cool, attract active soil life and decay to later improve the soil when it's all tilled under. These strawberries were soon lush and sweet.*

If you have a winter cover crop of rye that has grown waist high in the spring, you might not want to till it under because it is too much organic material to use so soon before planting. The same principle applies to Sudan grass that has grown chest high in late summer, as shown in Photo 5/37. Mow it down first, then till it under.

It is also better practice not to turn over that much green matter if you wish to plant garden crops in the same spot within 3 to 4 weeks. Instead, use a good old hand scythe, a power sickle mower, or even a heavy duty lawn mower to cut the crop down first. See Photos 5/37 and 5/38. Then rake it up and save it for garden mulch to be used later. Afterwards, till un-



(Photo 5/37) *Using hand scythe on cover crop.*



(Photo 5/38) *Mowing down Sudan grass.*

der the stubble of the Sudan grass that is left. See Photo 5/39.

The same crops used for green manuring can be grown just for the purpose of creating good mulch. These crops are mowed, dried and later spread about as mulch materials between rows of planted vegetables or berries.

Mulching conserves moisture, prevents erosion and evaporation, maintains even soil temperatures and keeps abundant soil life active and well fed as the mulch decays from underneath. These conditions, along with the surface soil being kept dark and cool by the mulch, attract earthworms which are so helpful in digesting organic matter and building up your soil.



(Photo 5/39) Tilling under Sudan grass stubble.

LEAF COMPOST IMPROVES SOIL

All of the nutrients and trace minerals present in rotted leaves from a leaf compost pile from the previous fall make great additions to areas that have poor soil where you wish to garden. Shown in Photo 5/40 is Dean Leith filling a cart load of leaf compost to take to an area that will be a part of an expanded garden.



(Photo 5/40) Loading cart with leaf compost.

The cart makes it easy to move a big load of leaf compost over to where you want it spread. Then, use a shovel to spread the compost around in layers four or five inches high, as shown in Photo 5/41.

When the leaf compost is spread around the area to be improved, simply till it in, as shown in Photo 5/42, and wait for a few days for the soil life to work on it. Then, till it once more, and if the leaves are sufficiently covered with soil, either sow a cover crop in the area or plant a regular crop.



(Photo 5/41) Adding compost to new garden area.

Leaf compost is such valuable material for your garden that it can be best used when planting crops (mixed with a little soil). A good method in using this compost is to make a furrow, put in some leaf compost, mix it with a little soil and set in a tomato or other plant.



(Photo 5/42) Tilling under leaf compost.

BROADCAST PLANTING IN WIDE ROWS SAVES SPACE

Shown in Photo 5/43 is a row of lettuce and peas in a relatively compact area. The seeds were planted hand-broadcast-style lightly over an entire row to a ten-inch width. When the crop is finished, it gets tilled right under and another variety replanted over it or more seeds of the same variety are planted. Do this in three stages for a continuous supply throughout the growing season.



(Photo 5/43) Broadcast planting in wide rows.

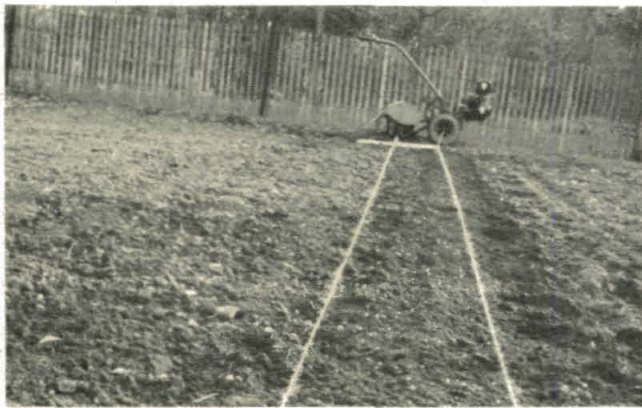

(Photo 5/44) Measuring off row with string.

The same procedure can be followed for spinach, peas, beans, kale, beets, carrots and several others. This thick, closely-spaced seeding method can produce excellent yields in Troy-Bilt gardens, where soil is unbelievably fertile from frequent tilling in of organic matter. The weeds are nearly eliminated because the close plant growth shades them out. Shading also holds moisture in the ground. Planting in very long, straight rows in this fashion also saves time in cultivating and saves space in the garden. Wide rows can be planted even ten feet wide.

Extra time spent in measuring the row with strings (as shown in Photo 5/44) will pay off in appearance, ease of picking and ability to closely cultivate between growing rows with a Troy-Bilt, without damage to the foliage.

ANOTHER SPACE SAVING METHOD

An annual supply of beans is easy to handle in this typical fashion, planted in two double rows as pictured in Photo 5/45. Leave room for a tiller width plus sidegrowth. Then, plant a double row on each side of the cultivating or mulch path. It is still required that seedlings be thinned according to the manufacturer's directions on the packet for full development of the plants.



(Photo 5/45) Double planted rows save space.

This section of a vegetable garden shown in Photo 5/46, makes the most use of its space by leaving just enough room between double-planted rows for walking and picking. After harvesting, the Troy-Bilt Roto Tiller-Power Composter will shred and turn under all this vegetation while still green without unbearable tangling with the tines.

Photo 5/47 shows a fast growing variety of lettuce utilizing a narrow strip between corn plantings. This is the Troy-Bilt method of truly maximizing use of available space.

IMPROVE ANY KIND OF SOIL

By turning under crop residues, cover crops, mulch, or compost, thousands of successful Troy-Bilt gardeners have improved their soil under all types of soil conditions. This formula will work with wet, mucky soils, heavy clays, rocky soils, hardpan, and sandy areas—see Photo 5/48. The same methods will also work quite successfully for hillside gardening.

SOIL AND MOISTURE CONDITIONS

Extreme soil and moisture conditions can affect tilling results. Don't work the soil when it is too wet. The soil will make too many clumps that won't break up as well as it would after a few dryer days. Too much drying following harvest, makes crop residues become stringy. Also, dried out soil becomes hard and makes residues more difficult to till under.

As a guideline, till under a crop as soon after harvest as you can while the crop is still green

and moist. And, if you have your choice of days, don't till after moderately heavy rains. If time will permit, wait a day or so for the ground to dry.

TRACTION

Sometimes owners will have a traction problem with wet clay-soil, wet heavy vegetation, tall weeds, or with extremely loose, lighter sandy soil (where spinning wheels may tend to bury the tiller). Sometimes a combination of soil and a slope will cause wheel traction problems. These situations can be overcome with tire chains on wheels, or the use of Bar Tread tires. See Photo 5/49 for use of tire chains to aid traction during tilling under tall grasses and weeds.

The Bar Tread tires have extra deep, tractor-type lugs to dig deeply and give the maximum pulling power. If you use the Dozer/Snow Blade with your tiller, we recommend the use of tire chains or Bar Tread tires for better and safer traction.

5



(Photo 5/46) Walk down center of double rows.



(Photo 5/47) Lettuce growing between corn.



(Photo 5/48) Turning under leaf compost.



(Photo 5/49) Chains add traction in tall grass.

BrentChalmers.com

TILLING UNDER CORNSTALKS

Soon after harvest, till under cornstalks while they are still green and fresh.

When corn is as high as shown in these photos and it is still nice and green, that's the time to till it under. When the stalks are dried out, they are tougher to handle and the roots pull out more easily. **YOU DON'T WANT TO PULL THE ROOTS OUT BY HAND BEFORE TILLING.** It is the action of the stalk, held in place by its root structure, being chopped against the soil that makes it so easy for your Troy-Bilt Roto Tiller-Power Composter to cut them down and chop them up, partially burying much of the cornstalk material in the first pass over.

How to go about knocking down cornstalks and tilling them under is not difficult once you understand two operating principles. **First**, you should get the stalks in between your LEFT wheel and the tiller transmission case. (The right wheel won't do because of the chance of interference by the stalks with the carburetor, air cleaner, and throttle linkage.)

Second, every pass you take should overlap one-half a tiller width over ground just tilled on the preceding pass. **And, you should till just as deeply as you tilled when you prepared the field for planting with your Troy-Bilt Tiller.**

Now, here's how to go about tilling under cornstalks. Please look at Sketch 5/50 of a Troy-Bilt Tiller indicating how it's done by a change in number each time there is a change in direction. **Set the tiller depth regulator at the 5th, 6th, 7th or 8th notch, depending upon the condition of your soil when you planted.**

The **first pass, No. 1**, is made alongside the row with the RIGHT wheel up close to, but not touching any cornstalk—see Photo 5/51. The **second pass No. 2**, will be over the row with the stalks in between the left wheel and the transmission case and it will also overlap the first pass by one half a tiller width. This permits the tiller to apply maximum power to the cornstalks—see Photo 5/52.

The initial pass over the stalks will just knock them down and cut some of them up in one or two foot lengths and partially bury them—see Photo 5/53. **On the third pass**, you will be going back over the stalks that are lying down, but this time from the opposite direction. This will bury much of the residue 3 or 4 inches un-

der the soil—see Photo 5/54. **The fourth pass** will be back down between rows overlapping one half over the number 3 pass—see Photo 5/55. **The fifth pass** will be back alongside the second row of cornstalks, with the right wheel up close, but not touching, the stalks—see Photo 5/56.

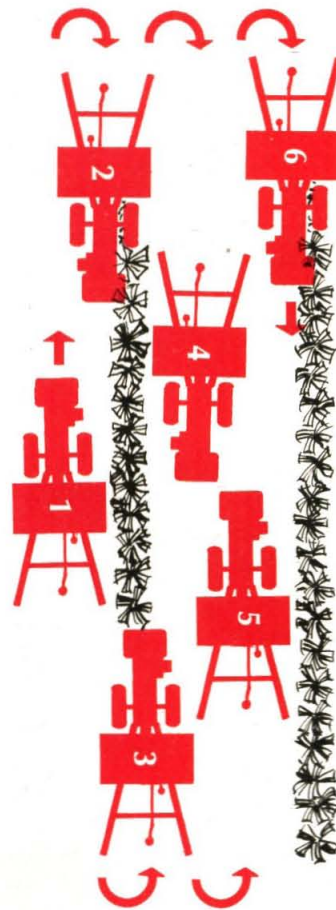

(Sketch 5/50) Tilling cornstalks.



(Photo 5/51) Right wheel up close.

The sixth pass will start to knock down the second row of stalks carefully guiding the stalks between the LEFT wheel and the transmission case. The process is repeated until the last row of stalks is down, chopped and tilled under in the opposite direction from which it was knocked down—see Photo 5/57.

When it's completed, you will know that you have done the best possible with your cornstalk residue to build up the mineral content and structure of your soil.

Allow the cornstalks to lie in the ground undisturbed for a week to give the active soil life a chance to start decomposition and digestion of the stalks. Then, come back and till in the residue of the stalks as deeply as you can. This probably will take only one overlapping pass through the garden. Then, you're ready to plant a new crop or a cover crop.

5

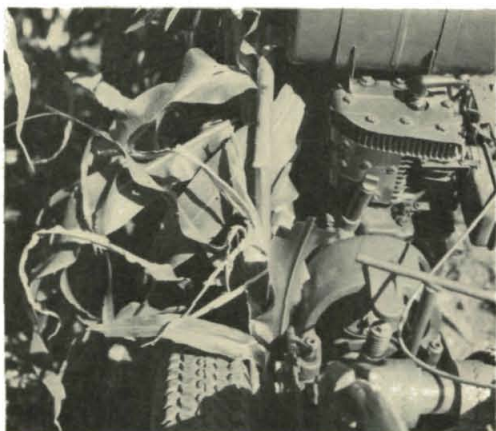

(Photo 5/52) Guide the tiller so that the cornstalks go between the left wheel and the transmission case.



(Photo 5/53) Use full power to chop the stalks as they are knocked down.



(Photo 5/54) Third pass goes back over stalks.



(Photo 5/55) Fourth pass is between rows.



(Photo 5/56) Fifth pass starts new row.



(Photo 5/57) Sixth pass repeats second.

OPTIONS & ATTACHMENTS

WHEEL AND TIRE ASSEMBLIES

Your Horse Model Troy-Bilt Tiller comes equipped with 4:80 x 8 tubeless tire mounted on a single piece steel wheel, shown in Photo 6/1. The wheel (which is described as an 8-inch wheel) has a self-contained hub section and includes an air valve.

The tires come in a Standard tread design that is either diamond shaped or a modified diamond shape. Bar tread tractor type tires are an option offered at additional expense. Bar tread tires which offer greater traction, are shown in Photo 6/2.

8" STANDARD TIRES AND WHEELS

Standard tires are excellent for most tilling and cultivating jobs with average soil and crop conditions; however, you may want to put chains on Standard tires for snowplowing or for tilling in extra tall and juicy cover crops, or tilling in tall grass while breaking in new ground. More information about Bar tread and tire chains is below.

Tires and wheels can only be purchased as a complete tire and wheel assembly (part #9142 for Standard tires and #'s 9143 & 9144 for Bar tread tires) from Garden Way Manufacturing Company, Inc. We are unable to supply the wheels or the tires to you separately.

In order to prevent throwing the tiller off balance, which makes it difficult to guide the tiller in a straight line, we recommend that you keep tire pressure equal. **Please maintain about 10 to 20 pound per square inch (PSI) air pressure in your tires for use in the garden.**

8" BAR TREAD TIRES AND WHEELS

This type of tire is particularly helpful for tilling in loose soil, snowplowing, earth moving, or when using the furrower attachment while tilling soil that has not been previously tilled. Bar tread tires are especially useful while tilling light soils, or sandy soils. You can get more traction with Bar tread tires than with Standard

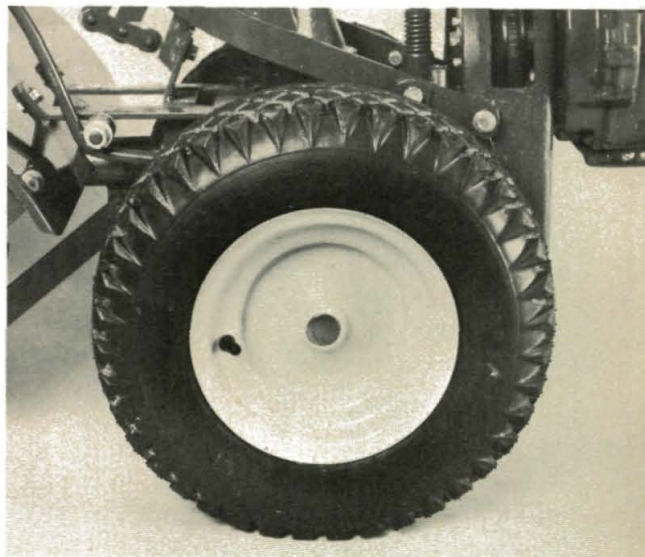

(Photo 6/1) 8" Wheel with standard tire.



(Photo 6/2) Bar Treads on 8" Wheels

tread tires. The 8-inch Bar tread tires and wheels can be used for all Troy-Bilt Horse Model Tillers (see Photo 6/2). Your tiller uses a 4:80/4:00 tire on an 8-inch wheel assembly (part #9143 and #9144, left and right). This is a tubeless tire, mounted on a single-piece, white steel wheel which is very similar to those on automobiles. They can be purchased only as a complete assembly.

ORDERING TIRES AND WHEELS

Please use the Master Parts Catalog for the Horse Model Troy-Bilt Roto Tiller-Power Composter and the Parts Order Form when ordering wheels and tires. Be sure to state the serial number of your tiller when ordering.

TIRE CHAINS

When extra traction is needed because of certain soil conditions or when snowplowing, the use of tire chains for either standard or Bar Tread tires can be very helpful (see Photo 6/4 and Photo 6/5). Here are some of the jobs you can do better when you put tire chains on your tiller:

6

Tilling in loose, sandy soil.

Snowplowing with a Dozer/Snow Blade.

Tilling on wet, slippery clay.

Grading with a Dozer/Snow Blade on loose and sandy soil, or wet or muddy ground.

Making drainage ditches with a furrower.

Tilling tall weeds, heavy cover crops, or extra thick vegetation.

Tilling previously untilled sod with the furrower attached.

If your soil is extremely loose, light or sandy, then your tiller may tend to bury itself due to loss of wheel traction (spinning tires)—especially when tilling deep at low throttle speeds. This is where tire chains are extra helpful.

When using your Troy-Bilt Dozer/Snow Blade for snow removal, tire chains can make the difference between poor traction and the positive pushing power you need. Photo 6/5 shows how tire chains can easily give your tiller more traction to handle light and medium snow falls with the Dozer/Snow Blade.

Tire chains can also be a great benefit if you use a dozer blade for moving soil or doing light grading. This is particularly true in wet grass or muddy ground.

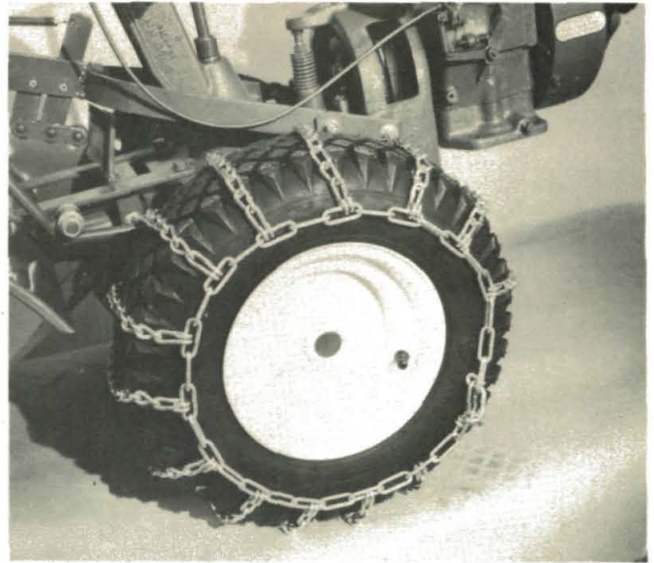

(Photo 6/3) Standard Tires With Chains

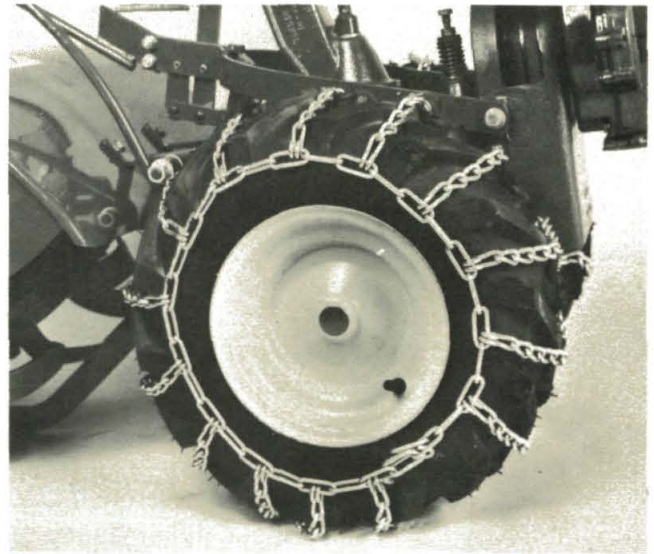

(Photo 6/4) Bar Tread Tires With Chains



(Photo 6/5) Chains give added traction.

BrentChalmers.com

Chains can give added traction while you are working on those very tough tilling jobs—such as heavy cover crops, tall weeds and thick vegetation.

Many Troy-Bilt owners find that the use of tire chains can be very helpful while using the tiller with the furrower blade attached to turn under previously untilled sod with thick tall weeds (see Photo 6/6).

HOW TO INSTALL CHAINS

1. Prop the tiller up under the wheel shaft or transmission with brick, pieces of 2" x 4" wood, or something sturdy, to raise the wheel off the ground a few inches (see Photo 6/7).

2. Lay one chain over a wheel, making sure the curled ends of the outside cross-links curve away from the tire (see **A** in Photo 6/8).

3. Put the hook-shaped fastener loosely through the last chain link on the inside of the wheels (see Photo 6/9) and rotate the wheel one-quarter turn so the fastener is now located at the front of the tiller. Then, hook up the outside fastener in the same manner.

4. Now, take up the slack in the cross-link chains at the bottom of the wheel by shifting the cross-chains around both sides of the wheel toward the top. (It is important that you take up as much slack as possible to fasten the chain).



(Photo 6/6) Chains help in tall vegetation.

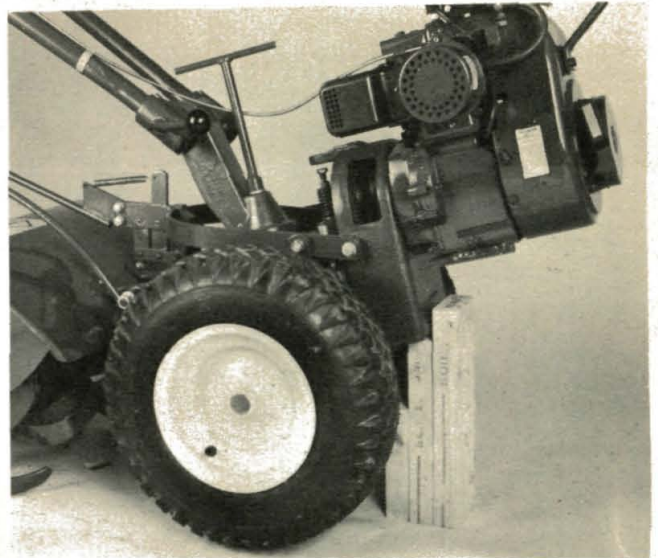

(Photo 6/7) Raise wheel off ground.

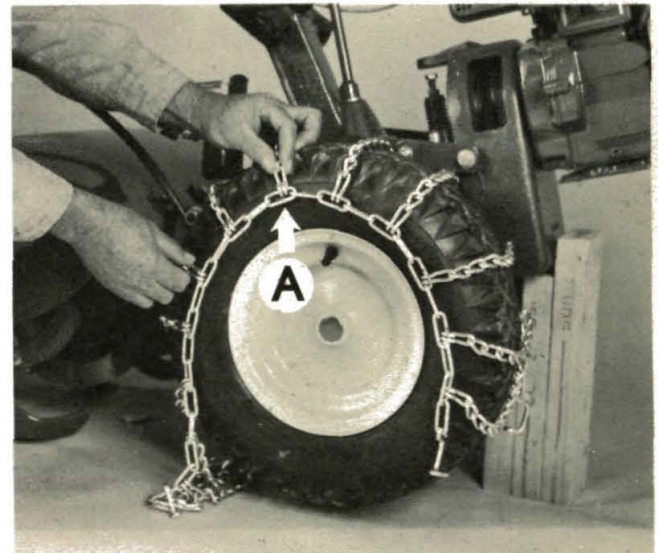

(Photo 6/8) Curled ends face outside.

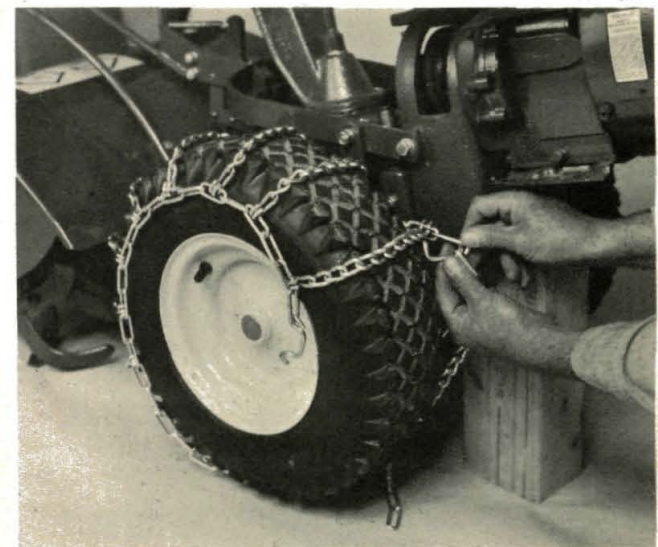

(Photo 6/9) First fasten chains loosely.

5. Bend the fastener on the inside of the wheel (nearest the tiller) backward and hook it around the link that is before the one holding the fastener (see **B** in Photo 6/10).

6. Bend the fastener on the outside of the wheel (furthest from the tiller) backward and hook it around the link that is before the one holding the fastener (see Photo 6/11).

7 Repeat steps 1 through 6 to attach the chains for the other wheel.

NOTE: If you would like your chains tighter, first run the tiller for ten or fifteen minutes until the chains properly locate themselves on the wheel. Then remove the fasteners and put them through the second link from the end of the chain. Then, repeat steps 5 and 6 (above).

6

ORDERING CHAINS

On your tiller and all tillers with serial numbers 31456 and up which have 4:80/4:00 x 8" tires, be sure you order 8" chains.

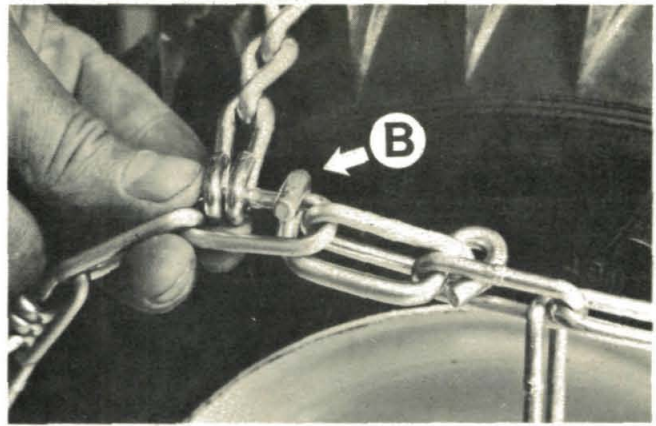

(Photo 6/10) Fasten chain tightly (tiller side).

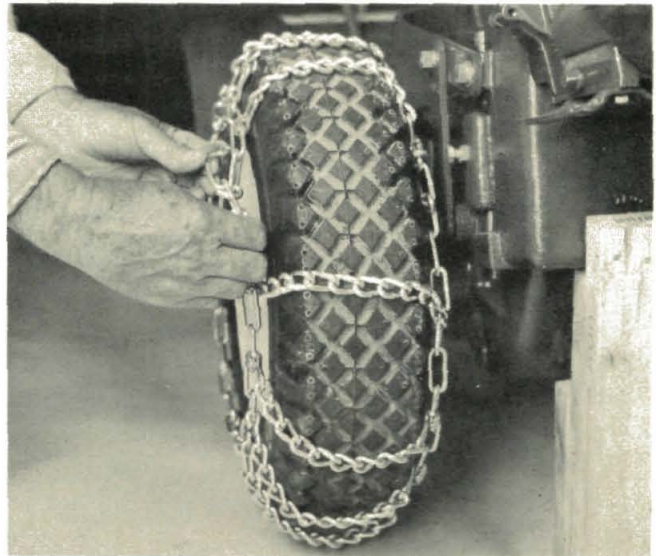

(Photo 6/11) Fasten chain tightly on outside.

DOZER/SNOW BLADE AND BUMPER ATTACHMENT BRACKET

Add year-round versatility to your Troy-Bilt Tiller and even get an extra bonus—because the attachment bracket also performs as a protective Bumper!

The Dozer/Snow Blade gives your tiller extra versatility—making it more useful in all four seasons. For those who must cope with snow, the dozer blade does a surprisingly good job in moving snow out of the way. For others, the dozer blade has been a great help in digging a base for a small swimming pool or even the pool itself! But, it's especially useful around the garden and yard.



(Photo 6/12) It's easy to relax when you have the Dozer blade to do the heavy work for you.

BrentChalmers.com

You can use the dozer to move dirt piles (see Photo 6/13), or create them, to clear stones from a garden or lawn area you're preparing, or doing light grading and to backfill trenches you've dug to bury pipe or outdoor wiring. Incidentally, you can dig those trenches with the help of a furrower and even the dozer.

If you have a large compost pile that you want to move around the dozer will use the Troy-Bilt's power to make light work of the task.

Some folks have used the dozer regularly to clean out a barn, while others have used it to assist them in making terraces for hillside gardening (please see Section 5 of this manual for our recommendations for tilling on a hillside and terracing).

The versatile Dozer/Snow Blade lets you use Troy-Bilt tractor power instead of hand-power. This, of course, could avoid the need to rent equipment for those occasional heavier jobs you're sure to run into. You'll save lots of time, and won't have to struggle with those heavy tasks when you have a Dozer/Snow Blade Attachment for your Troy-Bilt.

Put your tiller to work for you in winter months. Move a foot or more of light snow or 6-8 inches of heavy, wet snow, see Photo 6/14. Clear driveways and sidewalks clean to the pavement, or cut paths to your garage or out-buildings. (You probably ought to order tire chains for better traction in deep snow or icy conditions.)

BUILT TO BE EVER-SO-USEFUL

Maneuvering is solid and sure thanks to the driving power of the large wheels. The operator can control just how much dirt (or snow) the dozer moves with the handlebars.

The Bumper attachment bracket is manufactured from 1-inch steel tubing and it protects the carburetor and the engine blower housing from unexpected impacts (from trees, fences, walls, doorways, etc.).

You can set the blade at any one of five positions: straight ahead or at either of two angles on the right or left so you can do special jobs faster and better—see Photos 6/15 and 6/16. With this flexibility, you can move snow to either side of a walk, or backfill in one pass. Changing the blade angle in seconds is simply a matter of removing a pin and changing blade position.



(Photo 6/13) *Enlarging a pile of soil.*



(Photo 6/14) *Clearing a driveway of snow.*

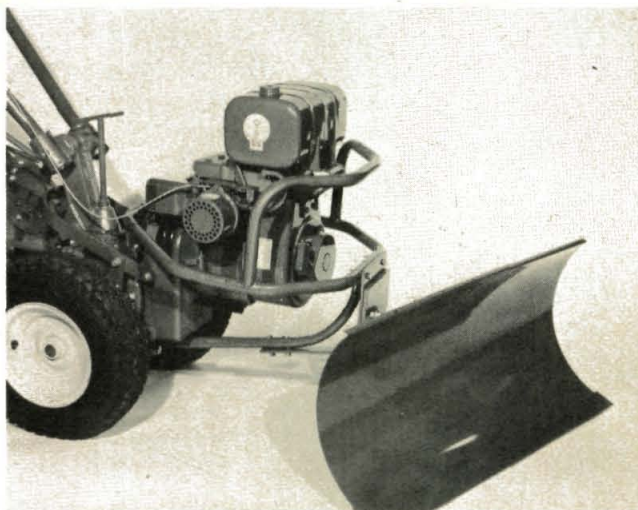

(Photo 6/15) *Dozer/Snow Blade Attachment.*

A GOOD MATCH BETWEEN BLADE AND TILLER

You get lots of "PUSHING POWER" for the tiller's size because of the Troy-Bilt's geared down transmission and two forward speeds. Having a High and Low gear is especially handy because it helps you get the greatest force or speed advantage, depending on whether the work is light or heavy. Of course, the tiller and blade is not a bulldozer meant to cut into unbroken soil or push very heavy loads...but it's a great investment at this very reasonable price!

During the summertime, spread any loose material like sand, mulch, compost, topsoil or organic materials...evenly and quickly—see Photos 6/16 and 6/17. Some people also use the tines to loosen soil up first—and then grade or

remove layers of unwanted soil. You'll also find that backfilling, depending on the size of the trench, is a lot less work with this sturdy blade.

Just like your Troy-Bilt Tiller, the Dozer/Snow Blade is built to last a lifetime. The Blade is made of tough steel, braced with ¼-inch bar stock. Its Bumper attaching bracket is made of one-inch, high-strength, steel tubing. All components are welded for added strength and then finished with our own special Troy-Bilt red paint.

Assembly is easy with the simple step-by-step instructions sent along with the Dozer Blade. And, there's no need for special tools or skills. It takes just a few minutes to take off the Blade (you just remove two bolts and the positioning pin) so you can do many different jobs at your convenience.

6



(Photo 6/16) Angle blade to one side to put soil where you want it.



(Photo 6/17) Moving soil to where it's needed.

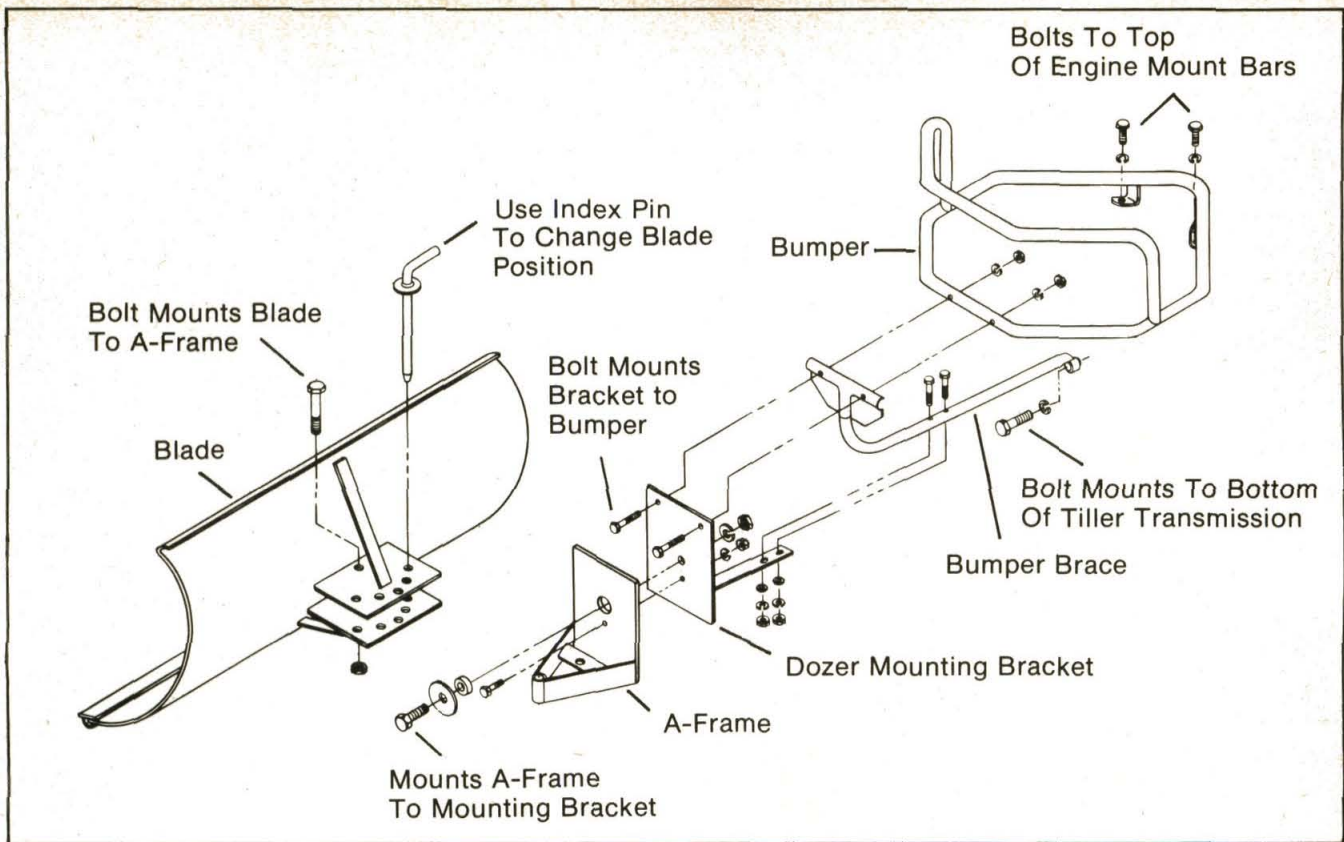

6

(Sketch 6/18) Dozer/Snow Blade components.

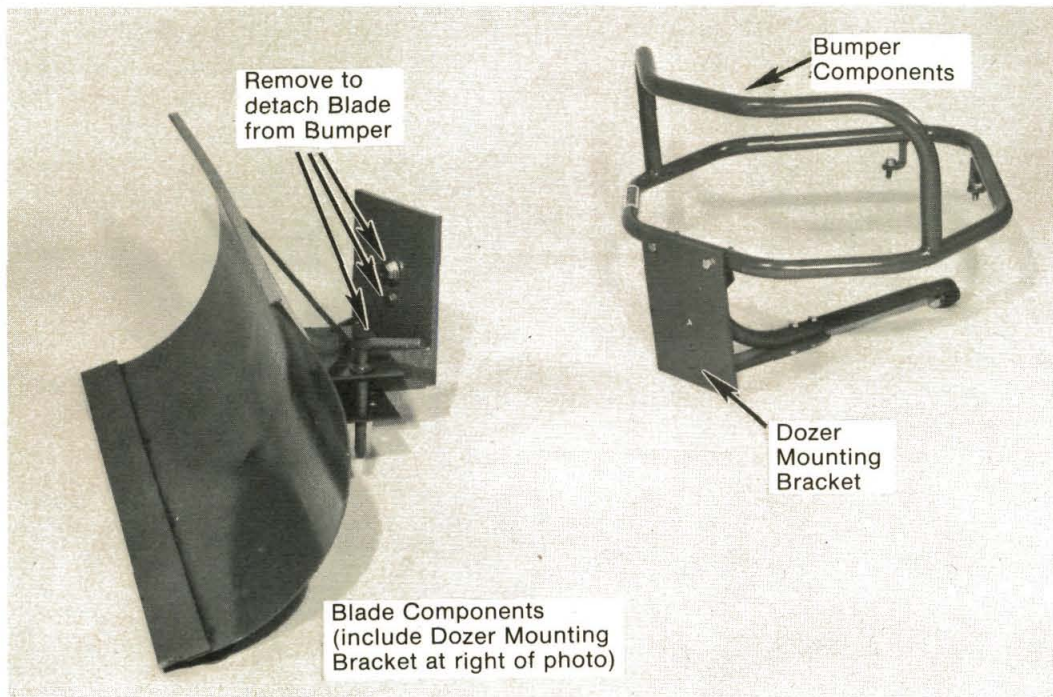

(Photo 6/19) Blade easily detaches from the tiller by removing two bolts and the index pin. It then leaves the useful Bumper and the blade attachment bracket on the tiller. The latter can be left in place, if desired.

ADJUSTING THE HANDLEBARS FOR EASY USAGE

When snowplowing or soil dozing, adjust the handlebars lower (slightly less than waist high) to give yourself more leverage to raise the Blade for banking, clearing obstacles and backing up.

If you lower the handlebars and find the crossbar interferes with your shifting into Reverse, as shown in Photo 6/20, switch inside ratchets shown in Photo 6/21 and that should give you a few more inches of clearance. If that doesn't work, you can bend the Forward/Reverse Lever a little by placing a wood 2x4 across the hood and pushing down on the lever. This will give you extra clearance and won't hurt the lever or its performance.

When dozing and plowing, keep your depth regulator on the tiller to protect the bottom of the tiller housing from the ground during banking operations and while clearing obstacles.

6

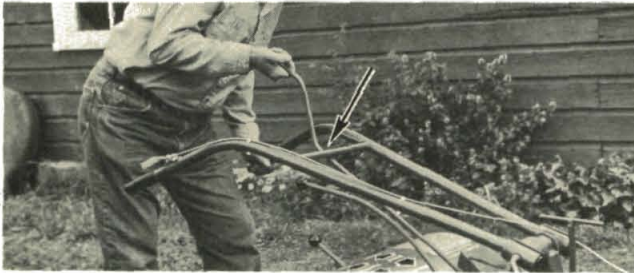

(Photo 6/20) If lever hits handlebar...

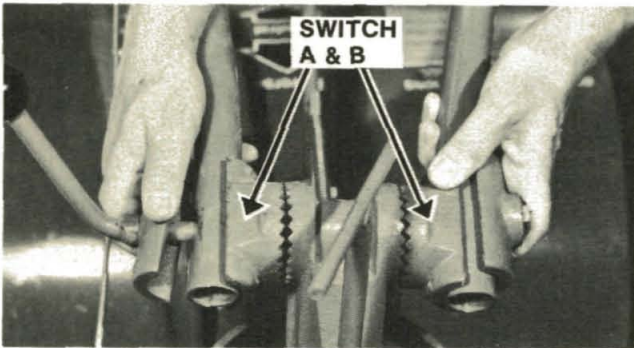

(Photo 6/21)—Switch the left and right hand inside ratchets with each other for added clearance.



(Photo 6/22) If needed, bend lever.

SAFETY NOTE: Remove tines in gangs while snow dozing especially. Icy drives are dangerous with revolving tines. It's best to remove when dozing dirt and stone too.

DIRT DOZING SUGGESTIONS

Your Dozer Blade is handy for lots of dirt moving jobs. In combination with the Hiller/Furrower and tines, you can make culverts, fill ditches, make a trench to bury cable, clean out barns, and do light grading, to name a few. Again, you'll get the most work from your Troy-Bilt Tiller and Dozer Blade if you use these hints...and then carefully experiment.

First, the Blade should be used for moving loose dirt...it can't dig into unbroken soil or hard packed piles like a big bulldozer. Thoroughly loosen soil with the tines (before you take them off for safety).

Next, the soil (or mulch, or manure) is best moved when it's nearly dry. If it's very wet, it can stick to the Blade, and the moisture's extra weight means you move less per pass. Also, when nearly dry, you can spread the material more evenly. It doesn't clump up.

Don't try to take too big a bite from a pile at once. Angle the Blade away from the pile and start at one edge. Then, spread the load evenly, with the Blade straight ahead. This way, when you "cut away" at a pile, the pile breaks itself up for you.

As for backfilling, that depends on how much you've dug up. Sometimes one or two passes will do it, with the blade angled toward the trench. Experimentation will help you find the best way.



(Photo 6/23) Tine removal permits you to raise the front higher, and the blade banks easier.

SNOWPLOWING SUGGESTIONS

Your Dozer/Snow Blade can move a remarkable amount of snow in a short time when you know how. Here are two snowplowing techniques we've developed that speed things up with a minimum of reverse maneuvering and Blade angle changing. Use the patterns as a guide and adapt them to your needs.

In deep snow, it is best to remove a top layer several inches thick in the first passes before attempting to remove all the snow. You might even start near the end of the drive in deeper snow and gradually work yourself back toward the house or garage.

For light snowfalls, make the first pass (Sketch 6/24) in the center of the area being plowed, with the Blade angled right. The Blade can remain in this position until the last pass, when the Blade is angled left as shown. Then you can finish off the job by building up snowbanks at the end of the cleared area by positioning the Blade straight ahead.

In moderate snow, begin plowing on the outer edge and work toward the middle (Sketch 6/25). The Blade should be angled away from the center for this operation. At the end of the last pass down the center follow the pattern for

light snow (Sketch 6/24). By moving the snow in this fashion, you will be duplicating some work, but deeper snows can be handled much more easily.

Another tip: If you bank snow down by the main road, in most towns, you should bank it on the right-hand side of the driveway. This way, when the town snowplow comes through, it won't push your snowbanks back into the entrance to your driveway, which it would if you had banked snow on the left.

Snowplowing should be done in high gear so you can "wing" the snow with the blade, and with the engine throttle cut back about 25 percent. Throttling down is very important. You should bank snow in low gear. Slowing down prevents too much buildup of momentum. If your Dozer Blade strikes an immovable object at high speed (which you're not likely to see under snow), the resulting shock could damage the gears in your transmission.

Also, don't try to drive the tiller when the wheels are frozen in the ground. Use hot water, for example, to free the wheels before you try to move the tiller under its own power and make sure that you've switched to SAE 90 gear oil in the tiller transmission.

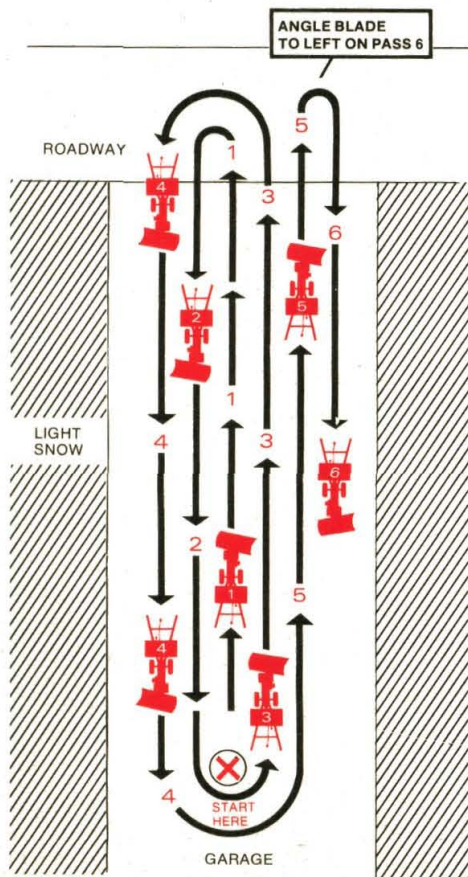

(Sketch 6/24)

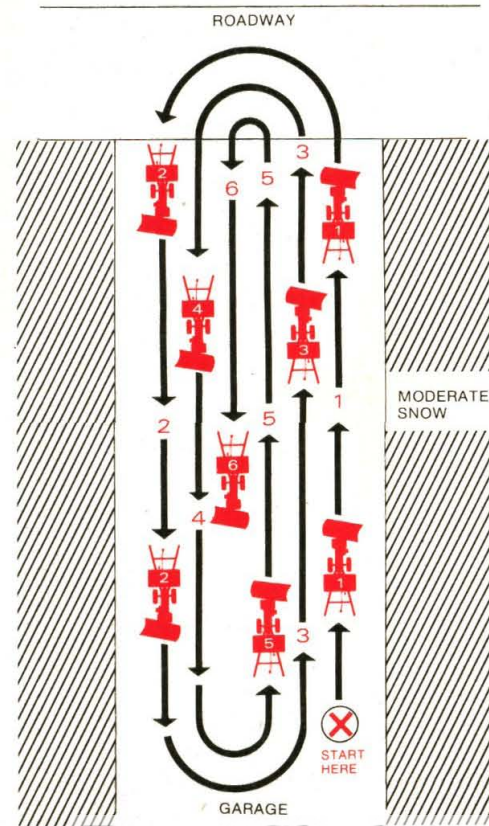

(Sketch 6/25)

BUMPER ATTACHMENT

The Bumper comes as an extra bonus when you buy the complete Dozer/Snow Blade Attachment, however, the Bumper is very useful in its own right. So, whether you purchase the complete Dozer/Snow Blade Attachment for the extra "two-in-one value," or just buy the Bumper alone, you will have a very useful addition to your Troy-Bilt.

Here's what it will do for you... **it will protect the engine against breakage from all sorts of blows** (we've even tested the Bumper and the tiller in the worst circumstances to make sure that it protects the carburetor and the blower housing, and it does).

The Bumper will protect your carburetor against mishaps such as bumping into trees, fences, posts (see Photos 6/27 and 6/28), garage and barn doorways, stone walls and parked vehicles. The cost of replacing a carburetor today is well worth avoiding a mishap.

6

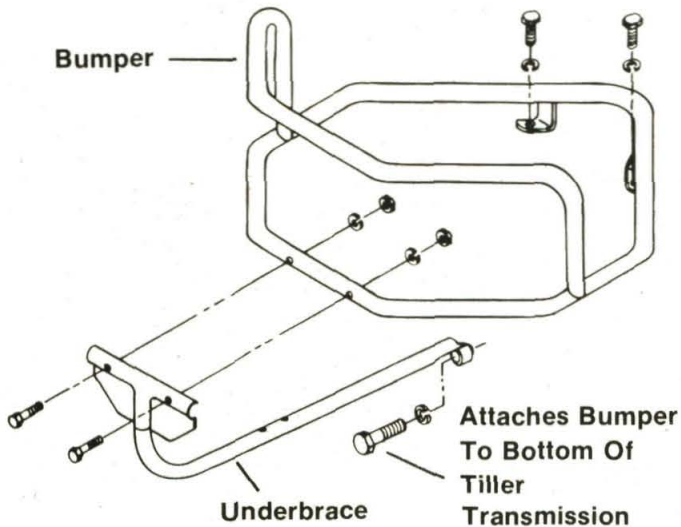

(Sketch 6/25A) Bumper Attachment

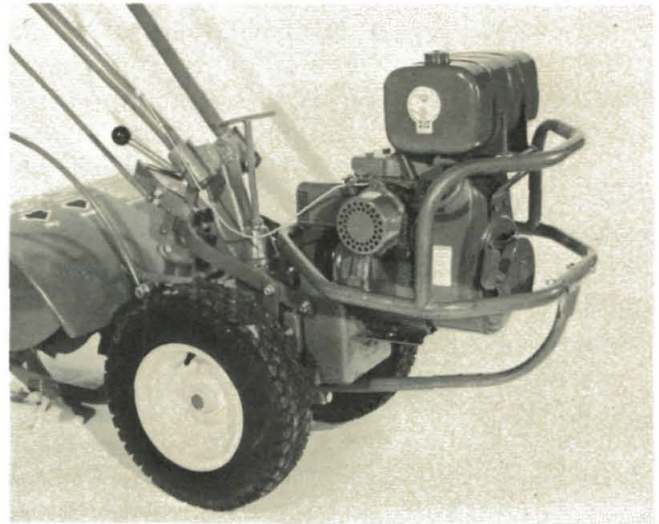

(Photo 6/26) The multi-purpose Bumper.



(Photo 6/27) Protects carburetor and engine from fences.



(Photo 6/28) Protects carburetor from fences, trees and doorways

The Bumper also protects your entire blower housing. You don't want to dent in the blower housing because the dented metal could rub or hit the flywheel, see Photos 6/29 and 6/30. The Bumper protects your tiller from that kind of damage. It also prevents a bent recoil starter cover which could interfere with the recoil starting mechanism—see Photo 6/31.

The Bumper will serve as a very handy tie-down in a trailer or a pickup truck. It will also give you a reliable handhold to pull or lift the tiller. If your attachment bolts are tight, don't worry, you can lift the entire tiller up in the air with the Bumper—we've tested that too. We have picked up tillers suspended only by the Bumper long enough to ensure that the Bumper would hold the weight for lifting the tiller into a pickup. Of course, we recommend simply driving the tiller up ramps into a pickup truck or van. It's a lot easier and more sensible.

If you decide to purchase a Dozer/Snow Blade after you have a Bumper—we have a special kit #1407 which includes easy-to-follow instructions for attaching the blade. All you'll need do is add a blade mounting bracket to your Bumper (see Photo 6/32) and attach the "A" frame to the blade and the mounting bracket.



(Photo 6/30) Solid obstacles like stone walls won't damage recoil starter.

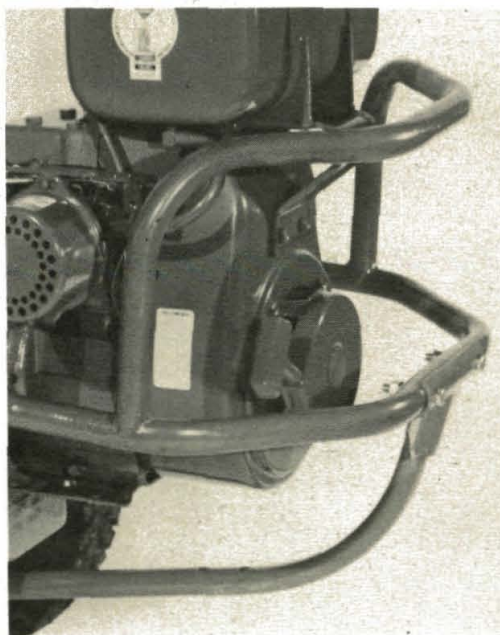

(Photo 6/31) Protects the recoil starter.



(Photo 6/29) Bumper protects engine while tiller is tilted for maintenance.



(Photo 6/32) It's easy to add the Dozer/Snow Blade to the Bumper—just add the brackets, the blade, and you're ready to go!

6

TROY-BILT HILLER/FURROWER

THE TROY-BILT HILLER/FURROWER COMBINES TWO TOOLS INTO ONE—WITH MANY WORKSAVING USES...

6

It Makes It Easier To:

- Drain wet garden areas to plant earlier.
- Make ditches for irrigation.
- Kill most weeds IN rows and BETWEEN plants.
- Mark rows to plant corn, beans, peas and many other vegetables and fruits.
- Transplant asparagus, strawberries, and most plants started indoors—like tomatoes, cabbages or melons.
- Grow better crops in wet or heavy soils by using “raised rows.”
- Plant potatoes. First furrow, then hill them.



(Photo 6/34) The instant on-off Hiller/Furrower speeds and simplifies planting of potatoes. It makes furrows up to 8 inches deep.

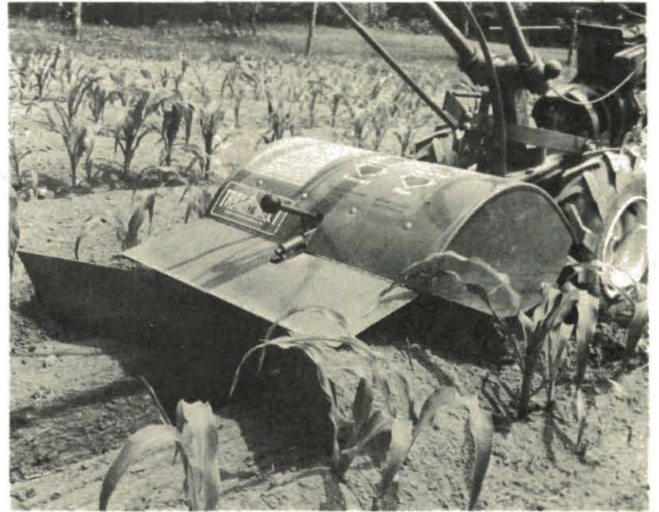

(Photo 6/33) The Hiller/Furrower “weeds” as it hills between the plants.



(Photo 6/35) When seed potatoes are in the ground, the labor saving Hiller wings will bury them. As potatoes grow, hill them as needed.

BrentChalmers.com

MAKE PLANTING CORN EASY

You can plant corn easily with the furrower. Just plant corn at the bottom and use chicken wire strips to keep the birds from eating the kernels you planted. Support the wire every 6 feet or so with sticks and hold the wire down with rocks—see Photo 6/36.

USE RAISED ROWS FOR WET SOIL OR HEAVY CLAY

It's easy to make raised rows with the Hiller/Furrower. Most crops can't grow in wet soil or heavy clay conditions because they can't get the air or nutrients they need for growth.

To correct these problem areas, make two parallel passes about three feet apart while the Hiller is angled upward. This will leave the middle area between passes as a "raised row."

TO GET BEST RESULTS FROM YOUR HILLER/FURROWER...

Tines should be left on the tiller when using the Hiller, or when furrowing. The tines throw soil at the Furrower and the Hiller wings move it ahead and to the side. So, make sure your soil is well broken up and loose before starting. If you plan to furrow in heavy clay or tough sod, till the soil thoroughly first. This will make it easier for you and your Troy-Bilt.



(Photo 6/36) Make an 8-inch furrow and plant corn and cover it with an inch of soil—gently tamped down. Then, cover the furrow with chicken wire strips.



(Photo 6/37) Raised rows help in wet soil.



(Photo 6/38) Some plants don't like to get their feet wet—"raised rows" avoid that.



(Photo 6/39) The Hiller/Furrower can save you back breaking work by eliminating much of your weeding chores.



(Photo 6/42) Dirt smothers weeds within row and also sturdies corn or other plant against storm damage.

6



(Photo 6/40) Hiller wings push dirt into plant rows.



(Photo 6/43) Furrower can dig drainage ditch to dry up an area for early planting in springtime.



(Photo 6/41) Wings and tines work together. Tines chop up growth between rows.



(Photo 6/44) In tackling tough sod, furrower can hold tiller back to allow tines more time to dig (use chains for traction)

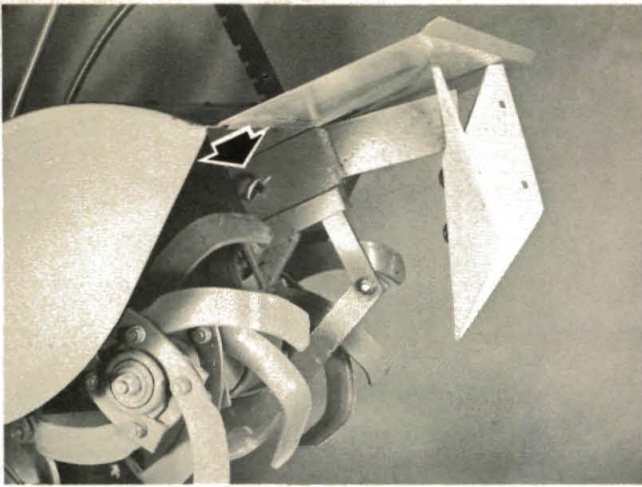

(Photo 6/45) The Furrower is held in place or released quickly by clinch pin (arrow).



(Photo 6/48) Push "U" shaped bracket over depth adjustment bar. Install clinch pin.

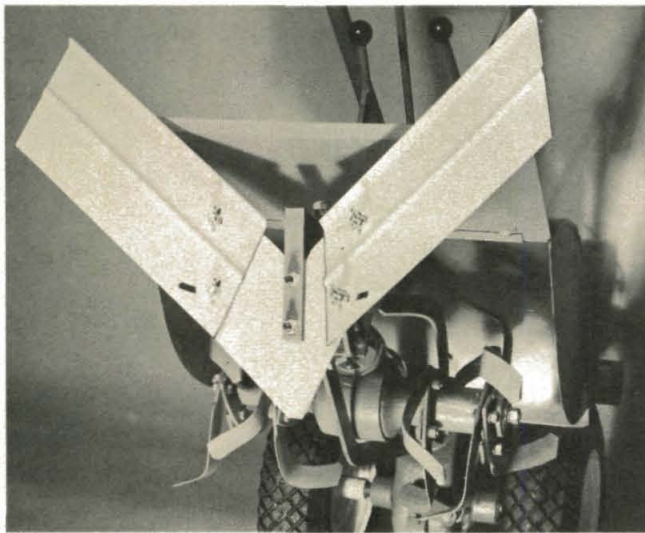

(Photo 6/46) Hiller/Furrower. Wings can be quickly adjusted or removed.

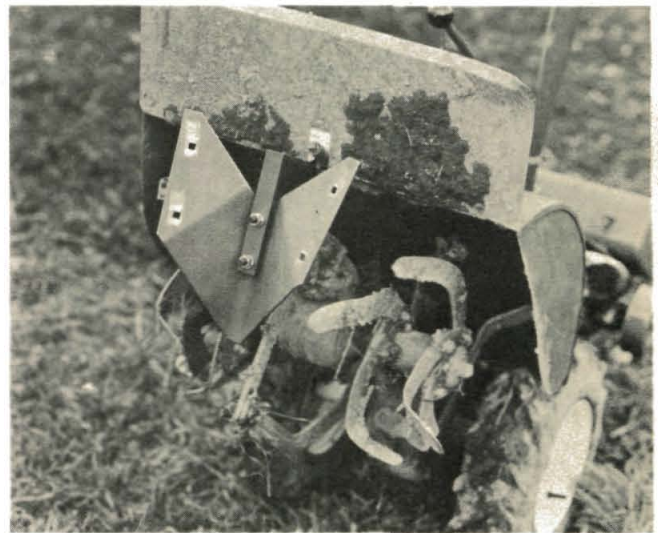

(Photo 6/49) Large carriage bolts go through blade first, then bracket.

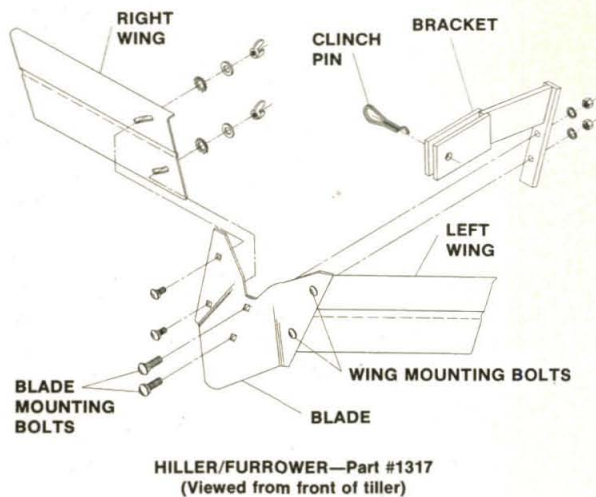

(Sketch 6/47) Complete attachment and its parts bolt together simply.



(Photo 6/50) Wings attach and adjust easily by hand. Wings go behind blade star washers up against wing.

TILLER & ENGINE MAINTENANCE

REGULAR MAINTENANCE SUGGESTIONS FOR THE TILLER

Lubrication points—please see Photo 7/1 and Photo 7/2 with the wheel removed to give you a closer view of some important lubrication points. The *numbered points* in Photo 7/1 show where you should apply some ordinary motor oil or other lubricating oil frequently; at least once a week if you are using your tiller quite often, or every two or three weeks if you are only using the tiller occasionally.

The *lettered points* indicate where you should apply a light grease occasionally to keep those parts well lubricated and working freely. The grease could be any general purpose grease, so long as it does the job of lubrication.

Next are descriptions listing those numbered points that need lubrication. Clean parts before lubricating.

LUBRICATE WITH OIL

1. Wheel speed shifting linkage, part #1231 and part #1033.
2. Oil hole in speed shift lever pivot point, part #1230.
3. Forward/Reverse Lever linkage and roller, part #1134 and #1042.
4. Yoke linkage (clutch control), part #1037.
5. Wheel axle (occasional spray of oil), part #1235.
6. Depth regulator bar, plunger and spring, part #1076, #1119, and #1120.
7. Handlebar height adjustment stud, thread and nut, part #1150 and #9805.
8. Throttle cable and casing.
9. Eccentric Shaft (outside).

LUBRICATE WITH GREASE

- A. Face of belt adjustment block, part #1133.
- B. Engine mounting bars, part #1034.

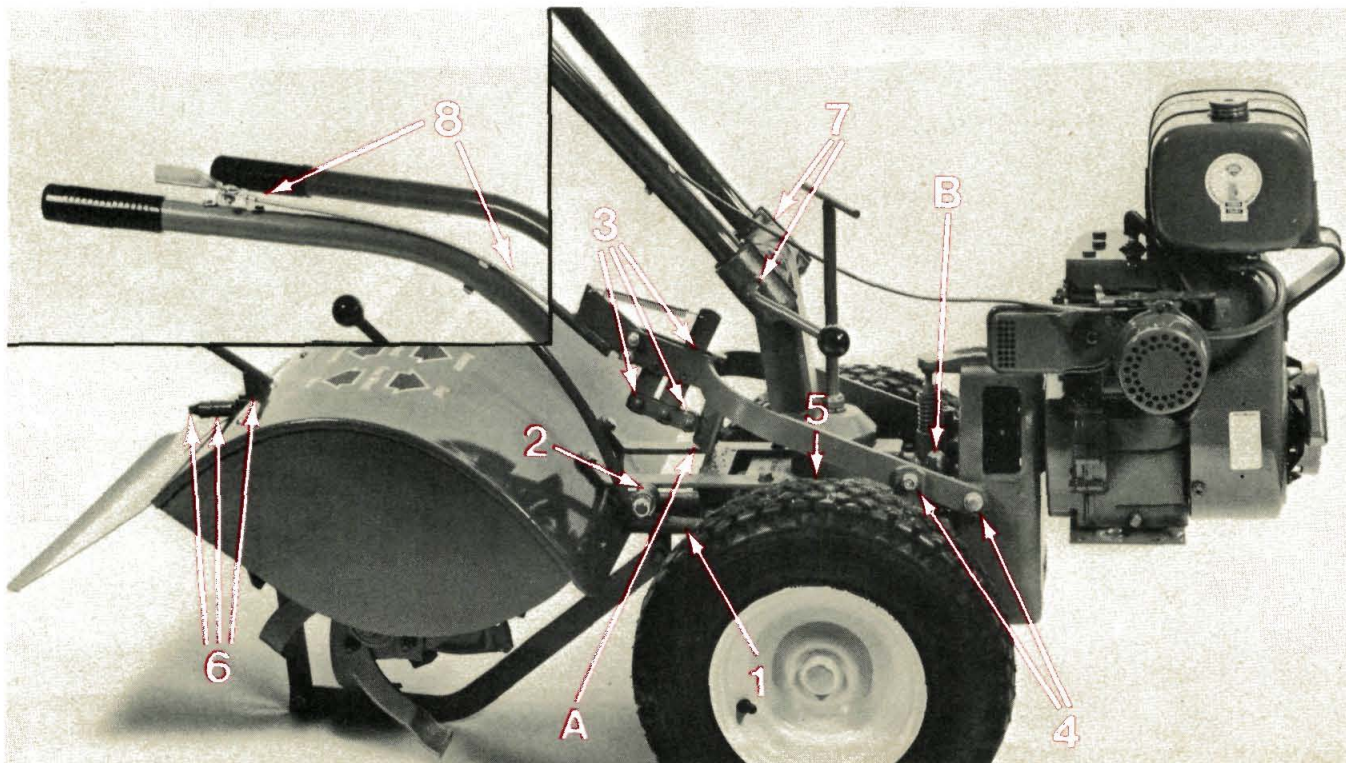

(Photo 7/1) Lubrication points on tiller.

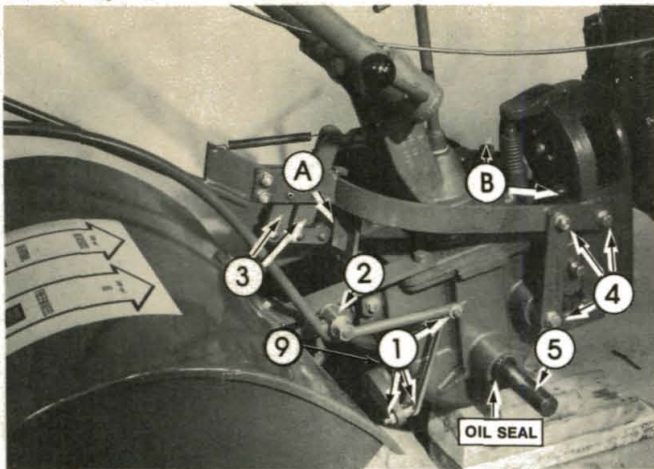

(Photo 7/2) Close-up of lubrication points.

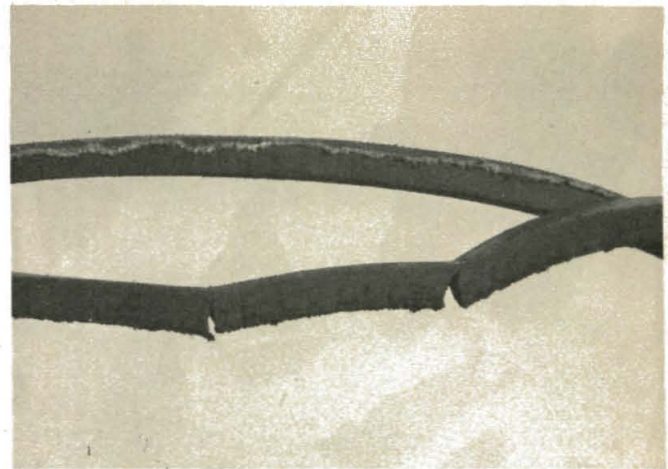

(Photo 7/3) Cracked and frayed belt.

BELT TENSION AFFECTS PERFORMANCE

Proper belt adjustment is necessary for good tiller performance. Tiller belts transfer power from the engine to the tiller transmission in order to drive the tiller wheels and tines forward.

Loose belts can lead to disappointing results. It is important that you check belt tension regularly and you look for signs of cracks, fraying and overstretching of the belts—see Photo 7/3. With reasonable care, the belts should last three or four seasons, perhaps even more, based on forty to sixty hours of normal use each season by the average home gardener. Take good care of your tiller and its belts. Do not jam the clutch lever in and out of Forward. Keep the belts properly adjusted, as described on page 95.

HOW TO TELL IF BELTS NEED TIGHTENING

Now, here's how to tell if the time has come when you must change your belts, or at least tighten them. If you put your engine under a load such as tilling deep, or chopping under thick heavy vegetation and notice that the tiller tines and wheels seem to slow down, seem to lose power, even though the engine continues to run smoothly and shows no loss of power, then this is a sign that the belts have stretched and begun to slip on the pulleys. For belt adjustment instructions, see page 95 of this section.

If you are in the process of adjusting belt tension and find that the previous belt adjustments have left the adjustment block (part #1133) as far down as it will go, and your belts are still too loose to do the proper job, then you definitely need a new set of belts.

Further evidence that the belts need tightening will be seen if the belts slip even during light or shallow cultivating, or *if you notice the belts slipping in Forward gear, but find tiller operation is perfectly normal in Reverse*. The tiller does not use the belts in Reverse. Instead, it uses the reverse disc to transfer engine power to the tiller transmission; therefore, *putting your tiller in Reverse will show you that the problem of slippage is not related to the gears, the engine, or the wheel drive, but to the belts alone*.

When the time to change belts comes, please order a matched set (one set) of belts (part #1128) from the factory. These belts are a special length, matched so that they will provide maximum transfer power from the engine to the tiller. They are also exceptionally durable belts made to last a long, long time (possibly as long as two or three tilling seasons). Please use a parts order form when ordering your belts.

TIGHTENING BOLTS AND NUTS

Troy-Bilt owners should make it a practice to regularly inspect and tighten bolts and nuts on their tiller. Please refer to the accompanying photos with arrows indicating nuts and bolts that should receive specific attention.

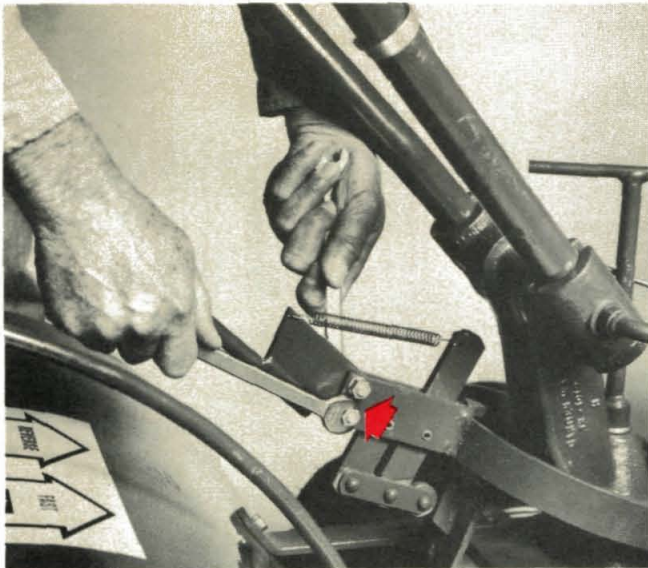

(Photo 7/4) Tighten Forward/Reverse Lever.

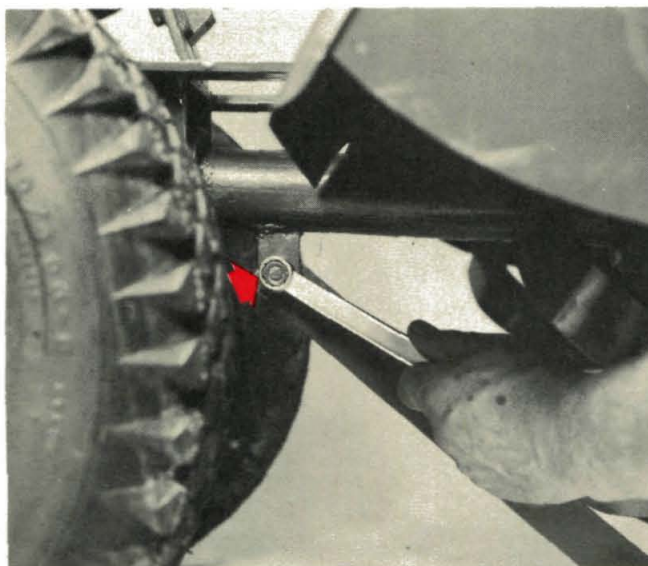

(Photo 7/5) Tighten drag bar to tiller.

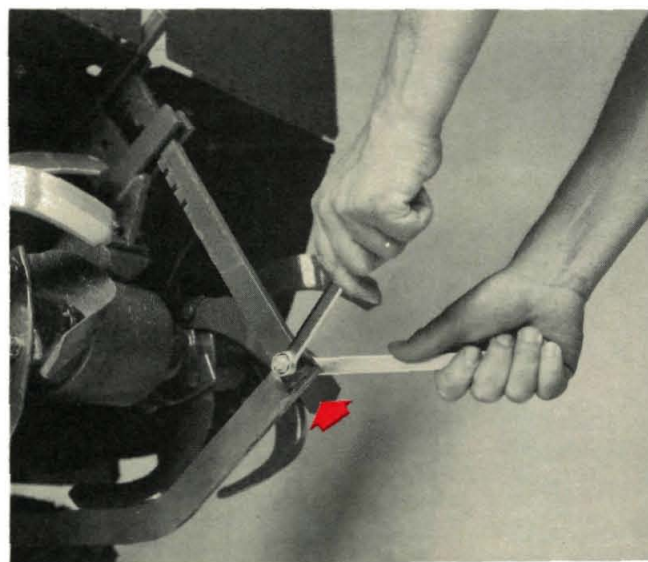

(Photo 7/6) Tighten drag bar and depth regulator.

Fairly frequently, check the two bolts and nuts that you use to fasten the Forward/Reverse Lever (part #1134) to your tiller—see Photo 7/4. Make sure that they hold without any wobble of the lever, but don't over-tighten and break the bolts. Also, check the linkage to the yoke (part # 1037) and the wheel speed shift lever (part # 1230).

Check the bolts fastening the drag bar (part #4763) to the tiller and to the depth regulator—see Photo 7/5 and 7/6. Check the bolts and nuts fastening the front and the rear hood bracket, see Photo 7/7

In the Spring and Fall, at least, check the end cap bolts under the rear hood bracket—see Photo 7/8. And, check the 3 hex flange bolts for tightness. Look for evidence of oil seepage between the end cap and the transmission tube. This will indicate that the shaft might need to be shimmed or that the 3 bolts have been loose. You can visually check for this condition by tilting the tiller forward and looking closely for wetness of oil that would attract dirt. As long as it looks like a tight fit and you see no oil, you can be fairly sure things are O.K. back there.

Finally, occasionally check the nuts and bolts that fasten the tines. Make sure they are tight.

On occasion, remove the tine holder on the left side so that you can reach the tiller housing cover (part #1023) and check the five socket head screws holding that cover in place—see Photo 7/9.

You especially should make certain that those five socket head screws are tight and that the cover is snug and shows no sign of any appreciable oil leak. A small amount of "wetness" with oil at that point on the cover is nothing to get excited about. A genuine loss of oil should receive attention at once.

It is also a good idea to check the reverse fiber disc (part #1072) and make sure that the mounting bolt attaching it to the pulley is firmly threaded in—see Photo 7/10.

CHECK THE PARTS FOR WEAR

The following parts should be checked regularly to determine if there is any adverse wear in the first few hours of operation. Thereafter, they should be checked regularly to make sure that they have not worn out. Check for wear of belts (see Page 93), the reverse disc (see page 104), the drag bar for the depth regulator, tiller tines (see Photo 7/11), and oil seals

for the wheel shaft (see Photo 7/2), and tiller shaft and the front seal on the drive shaft in the front of the transmission.

INSPECT THE TILLER AND TINES

Remove the tines and inspect the tiller housing cover on the left side for snugness of fit, the Allen screws for tightness, the keys in the tine shaft, the oil seal in the tiller housing cover, the oil seal on the right side, and the tines for excessive wear. Make sure that the tines are not bent so that any tines are touching the transmission housing.

When your Bolo tines become as badly worn as the tine shown on the right in Photo 7/11, you will begin to lose depth in tilling even though you adjust your depth regulator to the maximum depth. Also, when they become pointed, or sharpened, the tines will merely scratch the earth, but will not bury crop residues or sod like new ones. When this happens, it's then time to replace them. Also, as your tines become pointed and shorter with wear, they will leave a wide untilled middle section behind the tiller housing. Replace Bolo tines that have worn to a point.

When Pointed Pick tines become worn (see Photo 7/12), their pointed tips will wear and soon become much shorter. As a result, you will not get the digging capacity, nor the tilling depth. When the knife-like edge of the Cultivating tines become worn (see Photo 7/13), they will lose their ability to turn over soil. If the tines become as worn as those shown in Photo 7/12 and Photo 7/13, they should be replaced for more satisfying tilling results.

PROPER BELT ADJUSTMENT

It is *necessary* for good tiller performance to check tiller belts *regularly*! There are three ways to tell if your belts need adjustment or replacement.

1. If tiller wheels seem to slip—or don't drive forward well—check belt tension.
2. Look at belts for wear or frayed edges.
3. Look to see if belts are stretched—you won't be able to move the adjustment block any lower and belts will still be loose.

Loose belts can lead to disappointing results. That's why it's important that you check *regularly* for belt tension and for cracks, stretching and fraying. If a few strands from outer belt covering fray and come loose, trim them off with scissors.

On a brand-new tiller, wait until you have had

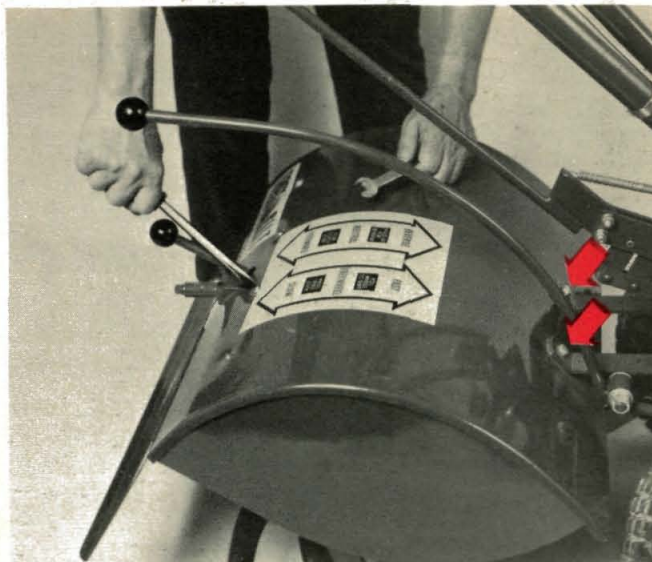

(Photo 7/7) Tighten bolts on hood brackets.

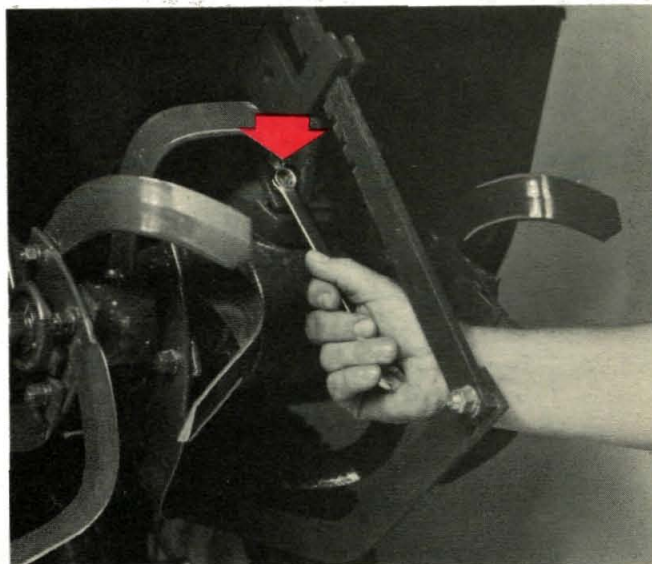

(Photo 7/8) Tighten bolt at end cap.

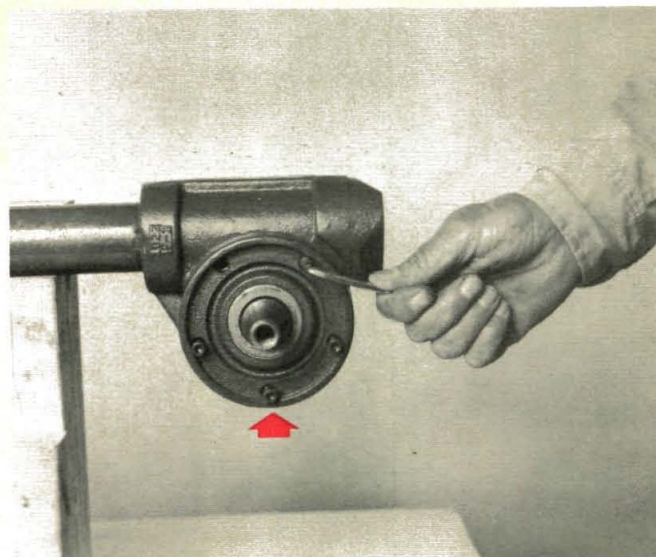

(Photo 7/9) Check tiller housing cover screws.

5 hours or more of operation before you consider *loosening the belts*. Give the parts and linkage enough time to wear-in and free themselves up.

If you take good care of your tiller and do not jam it hard in and out of forward, belts should last 3 to 4 seasons or more.

Belt adjustment—to check for belt adjustment, shift the Forward/Reverse Lever into **forward** gear while the engine is shut down. (Please disconnect the spark plug wire for safety.)

While the lever is in the **forward** position, take a ruler and use it to measure the distance from each belt to the inner side of the engine mount (part #1002) (as shown in Photo 7/14). Then, use moderate force to push each belt inward with the ruler and remeasure the same distance. The belts should deflect inward about $\frac{1}{4}$ ".

Please use the amount of belt deflection only as a guide. The performance of the tiller in the garden is a more reliable means of determining if belts are properly adjusted for the average gardener. Please refer to page 93 of this section under the heading, "How To Tell If Belts Need Tightening," for methods of detecting loose belts by tiller performance.

Belts should be an identical matched pair so that they both will transmit equal power to the pulleys. If the belts are so tight that you can't push them in with two fingers at all, or they are so loose that they go way in when you push them—while the Forward/Reverse Lever is engaged in the **forward** position, you'll have to make an adjustment.

TO ADJUST BELT TENSION

On the back of the adjustment block (part #1133) there is an adjustment bolt. Loosen the adjustment bolt, shift the Forward/Reverse Lever down into Forward position (as shown in Photo 7/15) and check the belt tension.

Stand alongside the tiller while holding the Forward/Reverse Lever down with your hand, and check the tension of the belts with your other hand by reaching through the hole on the side of the motor mount. Push the belts inward with two fingers—see Photo 7/16. (As a guide, the belts should deflect inward about $\frac{1}{4}$ ".)

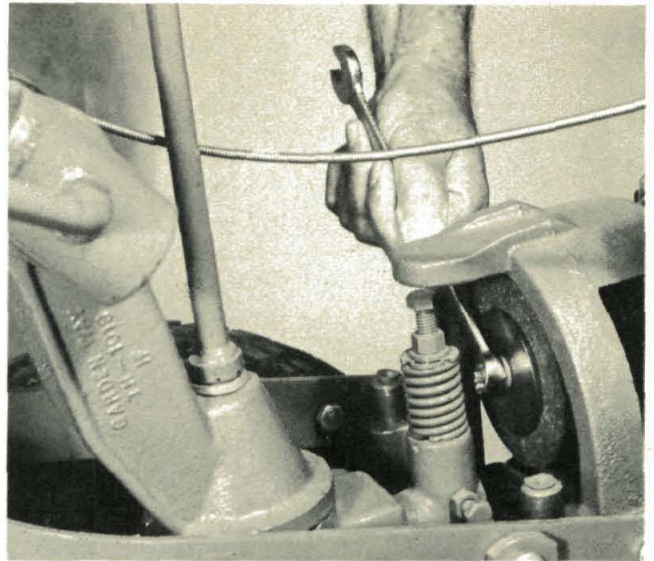

(Photo 7/10) Tighten reverse disc.



(Photo 7/11) Bolo Tines.



(Photo 7/12) Pointed Pick Tines.

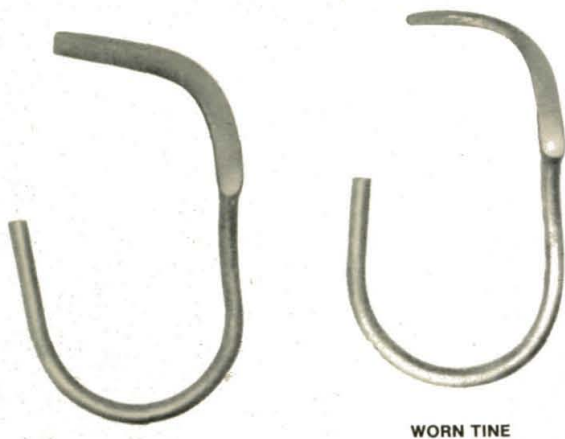

NEW TINE

WORN TINE

(Photo 7/13) *Cultivating Tines.*

If the belts are too loose, put the lever in Forward and slide the adjustment block down until the tension is enough to tighten them. Then, tighten the bolt a little more than finger tight. Put the lever in Forward and recheck the belt tension—see Photo 7/15. If you now have the right tension, tighten up the adjustment bolt and you are all set to go.

CAUTION: Do not set the belt *tension* too tight or your Forward/Neutral/Reverse Clutch Lever will keep jumping out of Forward. As you make succeeding adjustments in belt tension with the adjustment block (shown in Photo 7/15), the block will gradually be lowered in its mounting. **Another reason for a tiller “jumping” out of Forward is a weak clutch pawl spring, part #1122. Replace a weak spring.**

NOTE: The travel stop (arrow **E**) on the control yoke rests on top of the adjustment block (arrow **D**, shown in Photo 7/15). This prevents excessive belt stretching when shifting the clutch lever “in and out” of Forward.

It is worthwhile noting that the position that the clutch *roller* takes on the clutch adjustment block for *Neutral* will gradually work itself upward on the block. This happens gradually with each belt adjustment. When the block is all the way down to the bottom and the belts are still loose, it is time for a new set of belts. Write to our Parts Department for a new set of matched belts (part #1128).

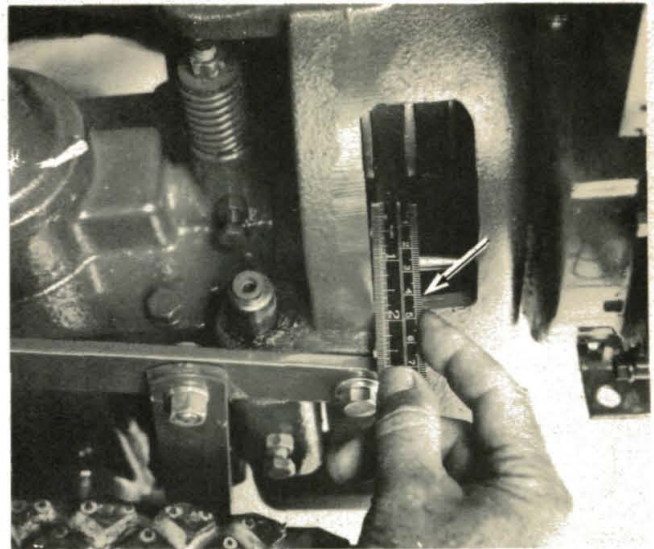

(Photo 7/14) *Measuring belt deflection.*

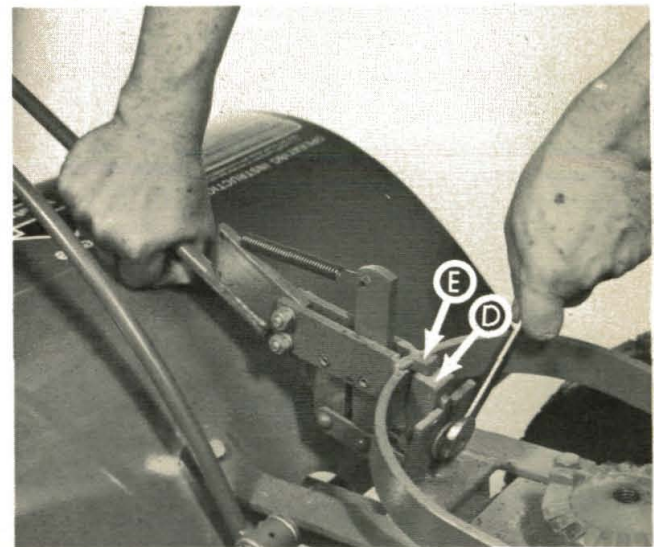

(Photo 7/15) *Adjusting tension of belts.*

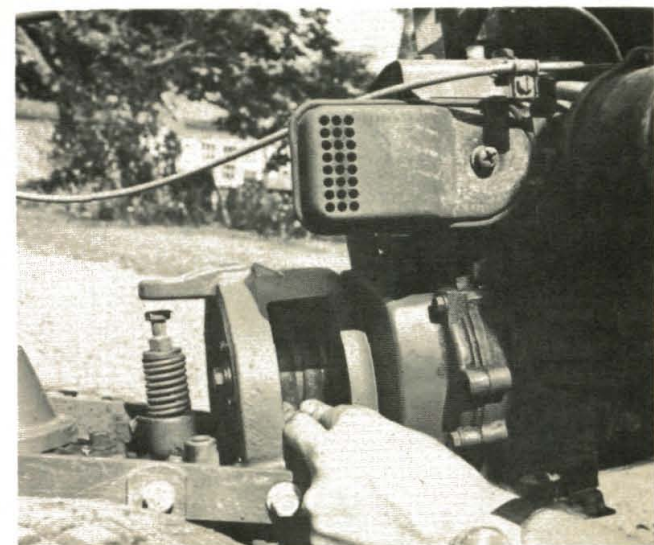

(Photo 7/16) *Checking belt tension.*

HOW TO CHANGE BELTS WITHOUT REMOVING THE ENGINE FROM YOUR TILLER

CAUTION: Before changing the belt, shut off the engine and disconnect the spark plug wire as a safety precaution.

It's easy to change belts on your tiller if you follow a few simple steps.

TO REMOVE BELTS

1. Shift the Forward/Reverse Lever (part #1134) into *Forward* position. Remove the mounting bolt and the metal plate in front of the reverse disc (part #1072)—see Photos 7/17 and 7/18.

To remove the top pulley mounting bolt, use a 9/16" closed-end wrench and a hammer. Stand on the left of the tiller, put the wrench on the bolt and give the wrench a sharp **tap** downward. This should loosen the bolt enough for it to come out easily. If the bolt doesn't loosen easily, insert a large screwdriver or wood stick between the upper pulley and the hole in the side of the motor mount. Pull up to prevent the pulley from rotating while you tap down to loosen the mounting bolt.

On the back of the shifting block (part #1133), there is a bolt used to make adjustments of belt tension (shown in Photo 7/19). Loosen the bolt enough so that the block itself moves up freely when you use the shift lever. When the block has been raised, retighten the bolt finger tight. Do not remove the bolt or block entirely.

NOTE: On electric start tillers, at this point, you should disconnect first the bolt and cable from the positive terminal of the battery and then disconnect the negative cable from the lower end of the 9 inch bolt on the bracket. While the nut is off the 9 inch bolt on the right, loosen the left hold-down bolt. Remove the battery and place it aside to give you working room. Be careful to note that the battery goes back on with the positive terminal on the left side of the tiller (viewed from operator's position).

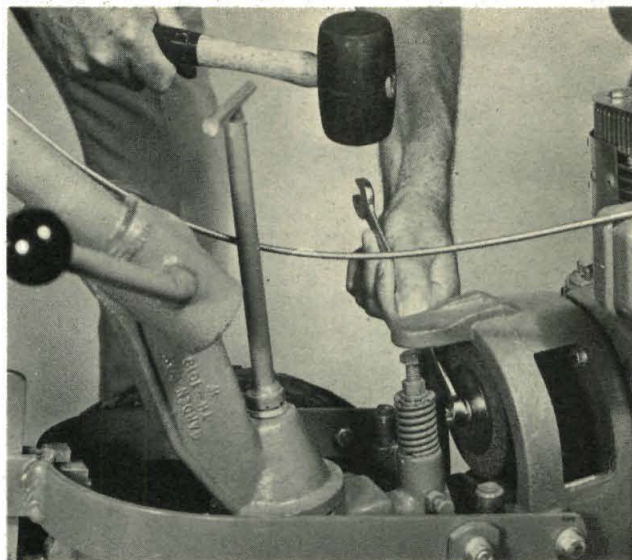

(Photo 7/17) Remove bolt in top pulley.

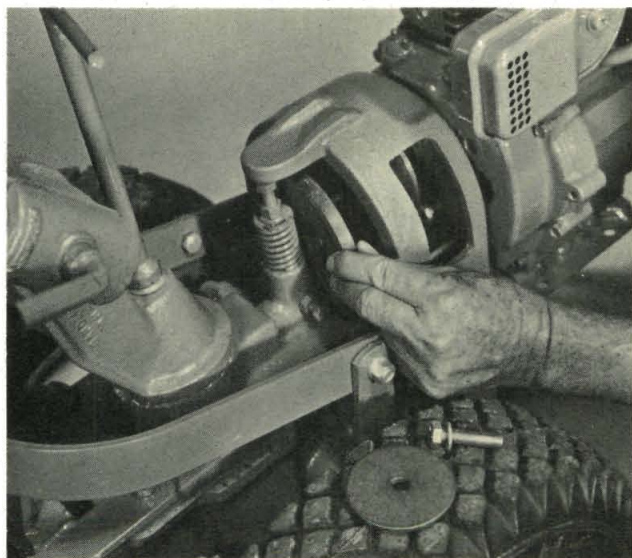

(Photo 7/18) Remove reverse disc.

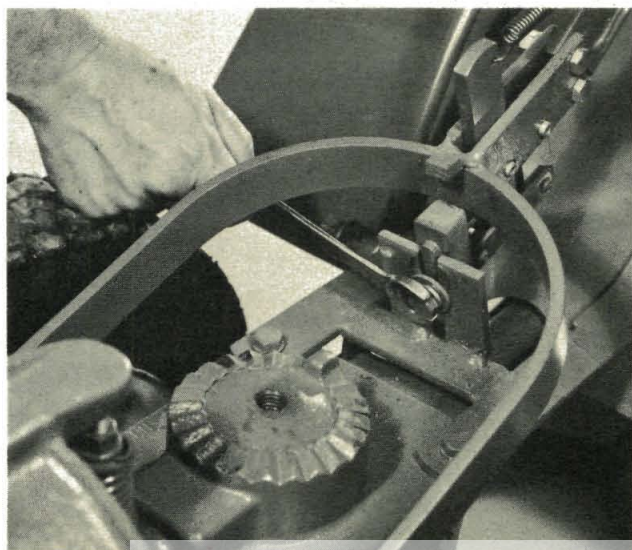

(Photo 7/19) Loosen bolt securing adjustment block.

REMOVING BELTS

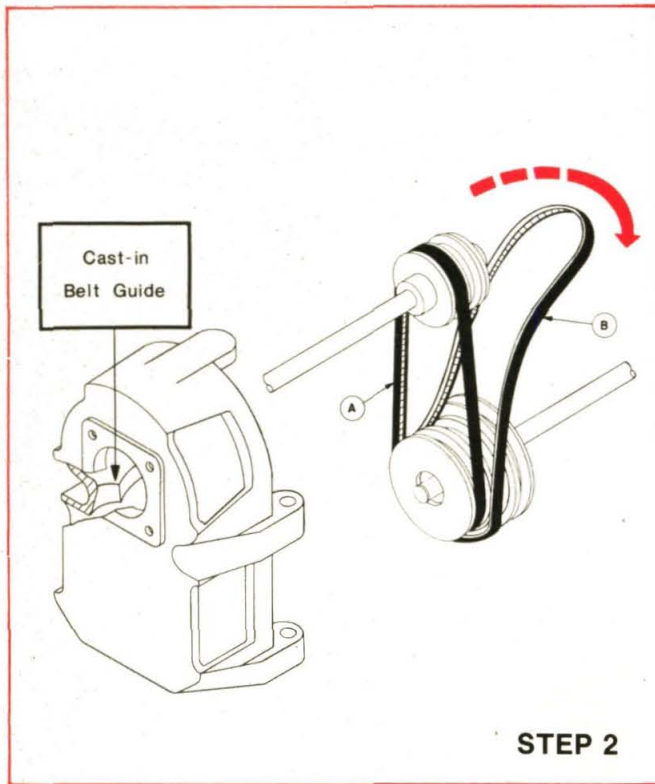

(Sketch 7/20-2)

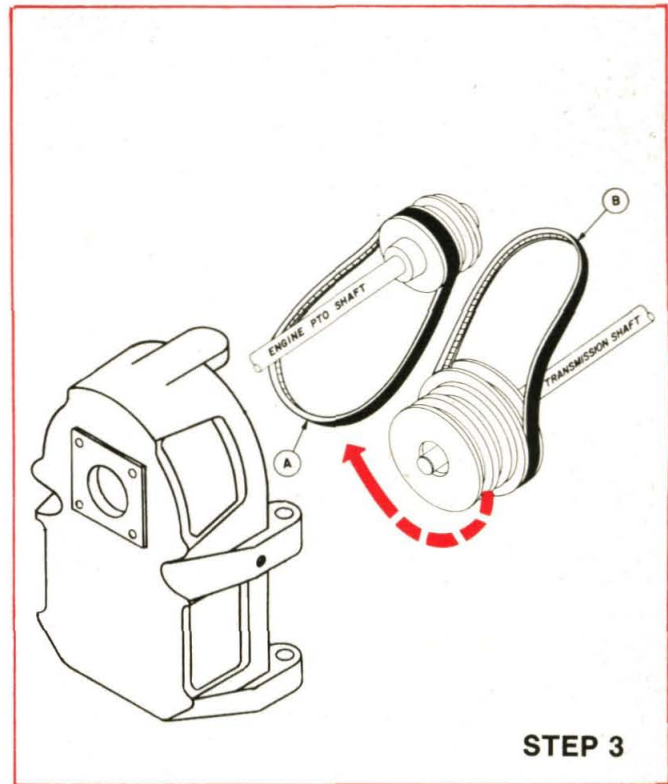

(Sketch 7/20-3)

2. Shift the Forward/Reverse Lever far enough toward *Reverse* to give slack to the belts. Move the belt marked **B** off the top pulley, in the direction of the handlebars. Let **B** remain there temporarily. (See step 2 in Sketch 7/20-2).

3. With the lever still in *Reverse*, free the belt marked **A** from the lower pulley and loop it under the lower pulley as shown. You may have to shift the lever toward *Forward* position to provide your hands clearance to work the belt upward over the pulley. (See step 3 in Sketch 7/20-3.)

4. Lift the belt marked **A** up over the top pulley and then shift the Forward/Reverse Lever into *Forward* position to provide clearance between the pulleys. (See step 4 in Sketch 7/20-4.) Now, you can pull belt **A** out between the pulleys. (Pull the belt toward the handlebars.)

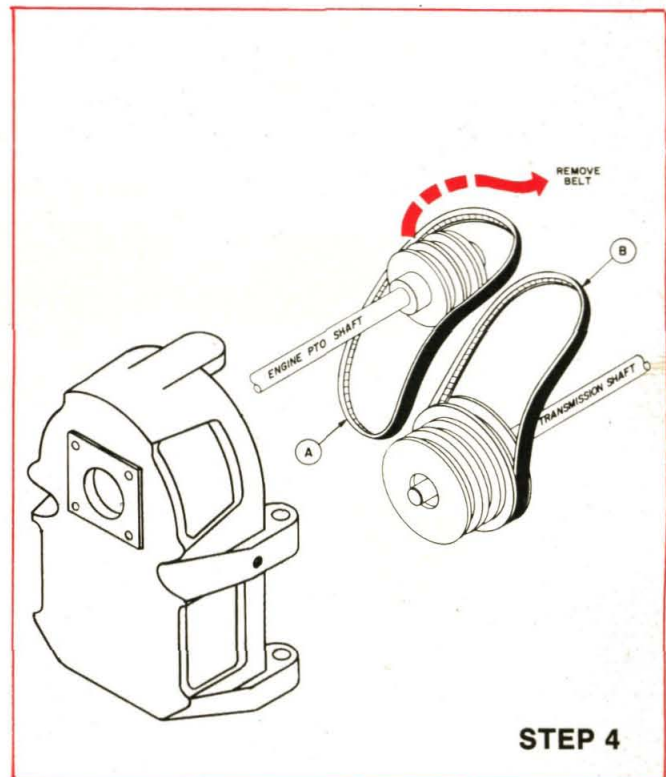

(Sketch 7/20-4)

REMOVING BELTS

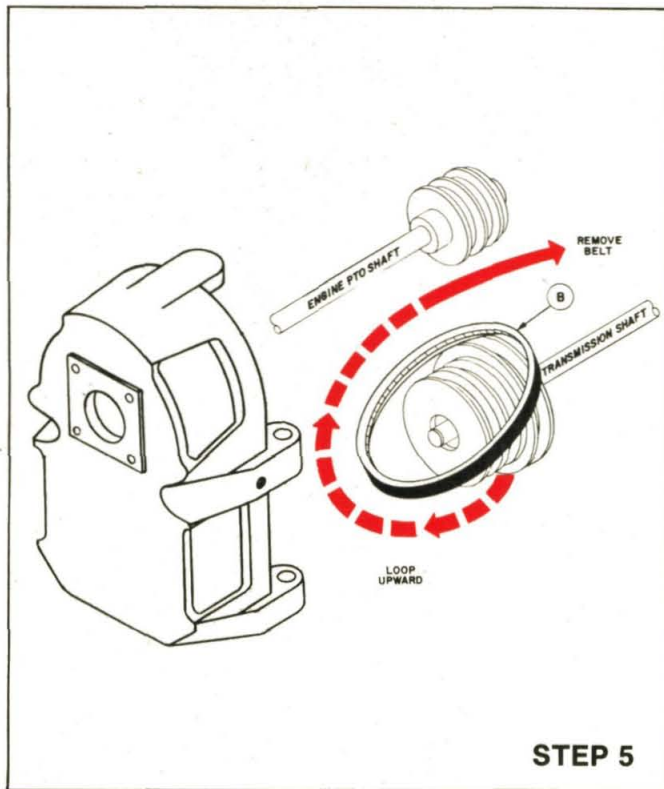

STEP 5

(Sketch 7/20-5)

INSTALLING BELTS

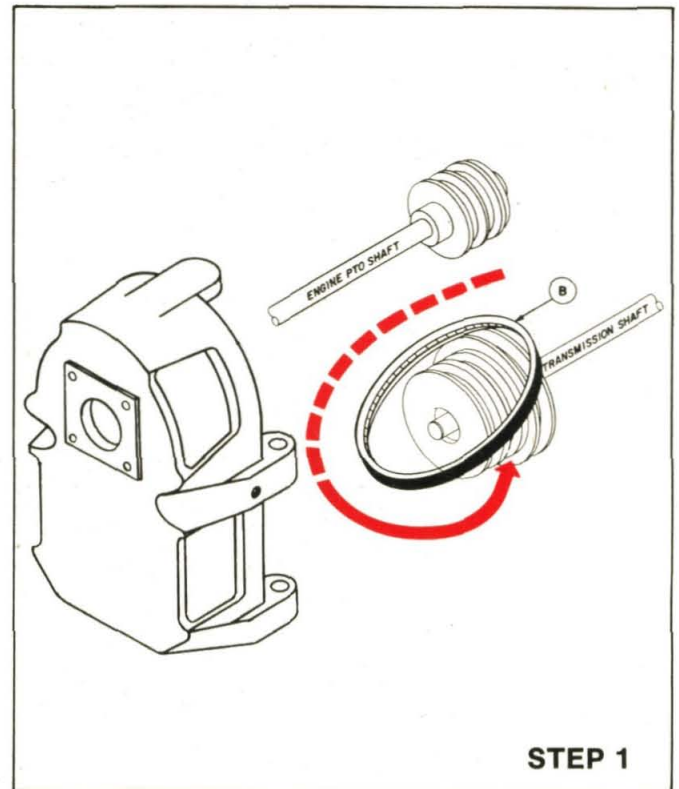

STEP 1

(Sketch 7/21-1)

7

5. Bring the bottom of belt **B** under the lower pulley and loop upward. Pull the belt out between the two pulleys, as you did in Step 4. Now you are ready to install the new set of matched belts (part #1128). (See step 5 in Sketch 7/20-5.)

TO INSTALL BELTS

To install new belts, use a matched set of belts only, because they deliver all of the engine power to your tiller. First, start with the shift block loosened and the reverse disc removed, as described in Step 1 of "To Remove Belts."

1. Shift the Forward/Reverse Lever into *Forward* position and move a new belt between the pulleys. Loop one end of the belt over the lower pulley. Bring the lower end of the belt toward the tiller—anywhere past the groove closest to the engine, as shown in Sketch 7/21-1. Let that belt lie there, out of your way.

2. Take the second belt and move it over the top pulley into the groove closest to the engine. Be careful to keep the belts near the cast-in belt-guides (shown in Sketch 7/21-2). **Keep the belts well inside the motor mount beyond the largest groove (for the Reverse Disc) of the lower pulley. This will avoid getting the belt jammed between the two pulleys.**

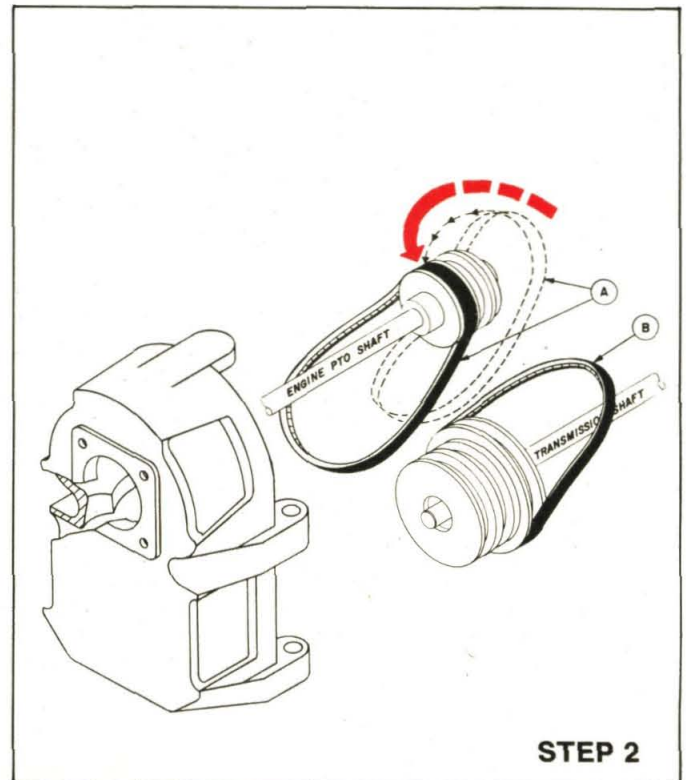

STEP 2

(Sketch 7/21-2)

INSTALLING BELTS

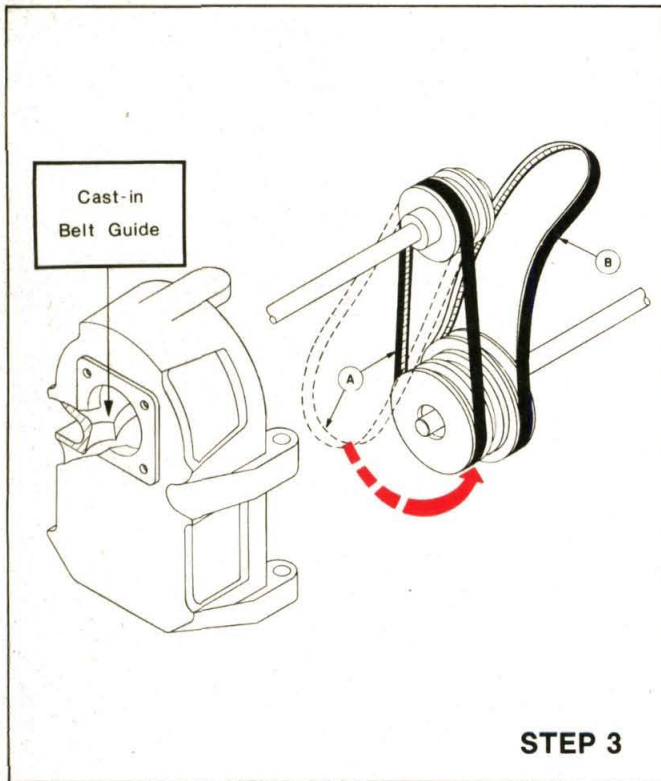

(Sketch 7/21-3)

3. Shift the Forward/Reverse Lever into *Reverse* position and move the belt marked **A** (in illustration) under the lower pulley. Place the belt in the grooves closest to the engine—see Sketch 7/21-3. To assist in seating the belt in the lower pulley, you can turn the lower pulley with your fingers. This will seat a belt that is almost in the grooves.

4. Seat belt **B** in the middle groove of the lower pulley and pull the top of the belt over the top pulley—see Sketch 7/21-4. To help get the second belt into the groove, you can put it in the lower pulley groove and then in the top pulley groove (on the carburetor and muffler side of

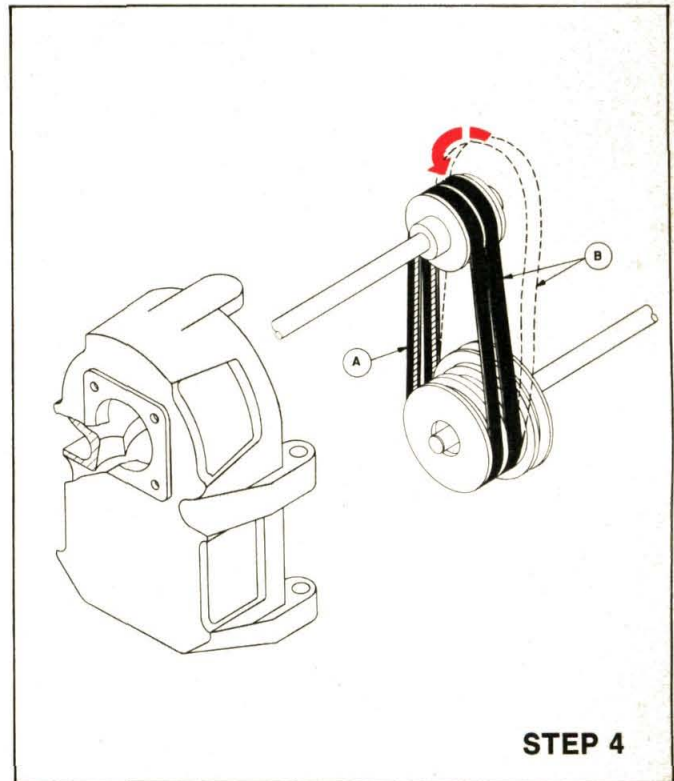

(Sketch 7/21-4)

the engine). When it is almost in the groove, pull the engine starter cord to seat the belt. (Remember, for safety, the spark plug wires should be disconnected).

5. Replace the reverse disc, the mounting plate and the large bolt. (Refer to Photos 7/17 and 7/18 under “To Remove Belts” for guidance.) Tighten bolt securely. Then, readjust the belt tension to $\frac{1}{4}$ ” belt deflection in *Forward* shift position as described in the preceding “Belt Adjustment Instructions.” First, position the block (shown in Photo 7/19) and tighten the bolt a little more than finger-tight, then, adjust the belt tension.

HOW TO ADJUST & MAINTAIN REVERSE

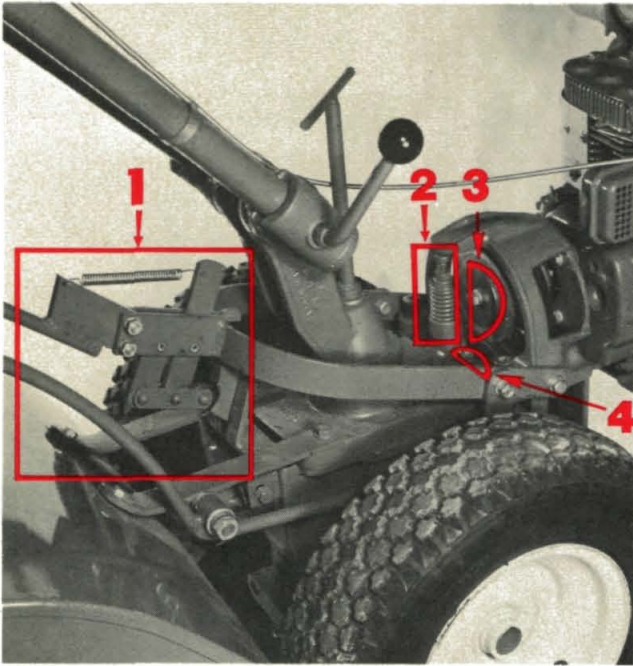

(Photo 7/22) To operate a Troy-Bilt, you know that you must **LIFT** and **HOLD** the Forward/Reverse Lever in upward position in order to reverse the tiller at all. When you do, this brings into play primarily four components that control the tiller's reverse action: (1) the Forward/Reverse Assembly, (2) the Reverse Spring and Plunger Assembly, (3) the reverse disc, and (4) the transmission drive pulley.

CHECK FOR PROPER REVERSE DISC ADJUSTMENT

7

Put the Forward/Reverse Lever in Neutral Position so that the clutch roller is resting within the indentation on the belt adjustment block (as shown by arrow in Photo 7/23). The lever should not be in Forward or Reverse.

If all is properly adjusted in Neutral, the cast-iron motor mount (part #1002) should be resting (as shown in Photo 7/24) squarely on top of the plunger bolt, or close enough to it so that you can hardly see daylight between them.

Neutral position does not have to be at any specific position within the indentation or on the face of the adjustment block (Part #1133) (as shown in Photo 7/23). The Neutral position that the roller takes on the adjustment block results primarily from the tension on the reverse spring and the overall length of the belts. As belts get older and stretch (sometimes not for a year or two), and as successive adjustments are made for belt tension, the Neutral position of the roller will gradually move higher and higher on the block—until the block hits bottom and there is no more adjustment room left because belts have stretched too much.

With the lever in Reverse and the motor mount pressing down on the reverse adjustment bolt

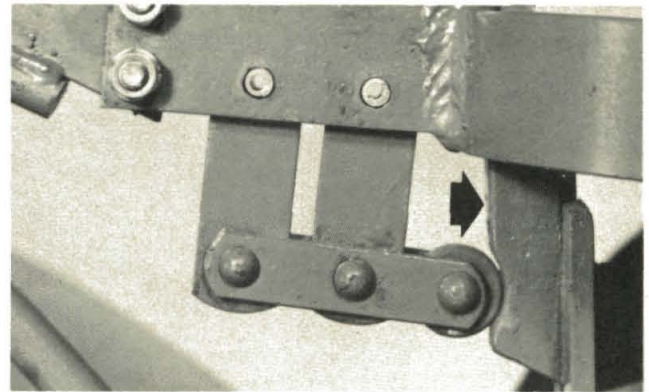

(Photo 7/23) New block has neutral position.

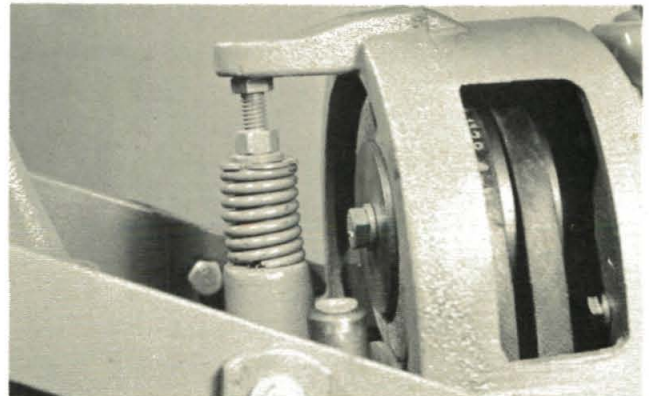

(Photo 7/24) Motor mount rests on plunger bolt.

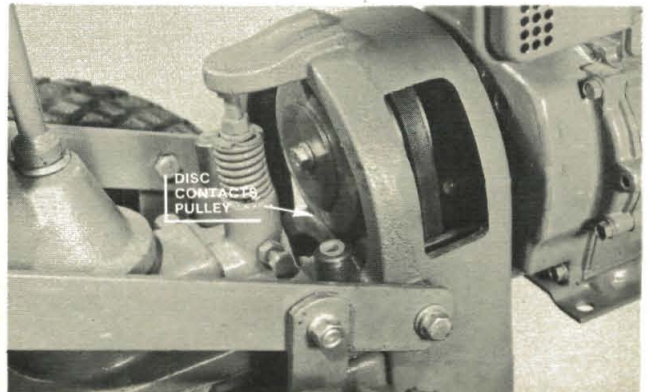

(Photo 7/25) With Forward/Reverse lever in reverse.

(on top of the plunger), the reverse disc should seat itself in the groove of the lower transmission pulley—see Photo 7/25. In Neutral, the reverse disc does not make contact with the pulleys (as shown in Photo 7/26, by arrow **A**). The distance the disc maintains above the pulley in *Neutral* varies with adjustment of the Reverse Spring and Plunger and the overall length of the belts. (Lubrication, or lack of lubrication of the yoke assembly and the engine mounting bars also influences the position of the roller on the block in *Neutral*).

WATCH ACTION OF REVERSE DISC & PULLEY

First, disconnect the spark plug wire from your engine. Then, squat along side the right side of your tiller to get a close-up view of the roller, reverse disc and lower pulley. Reach under the handlebar and pull the lever up into Reverse position (while you do, observe that the reverse disc is lowered into the pulley)—see Photo 7/25.

Now, while holding the lever in Reverse with your left hand, reach around in front of the engine with your right hand and pull the starter rope, briefly. You should see the reverse disc and lower pulley *both turn*—see Photo 7/27. Then, let go of the lever (the reverse disc will move a fraction of an inch away from the pulley) and pull the starter rope again. This time, the reverse disc will turn but the lower pulley *should not*—see Photo 7/28. If the lower pulley does turn, raise the reverse adjustment bolt upward a few turns until the pulley does not turn when the Forward/Reverse lever is released.

The Spring and Plunger Assembly is designed to prevent the reverse disc from making contact with the pulleys until the operator decides to shift into Reverse by lifting up on the Forward/Reverse Lever and holding it there. The lowering motor mount compresses the spring enough to “pop” the lever back into Neutral when it is released.

IF THE TILLER GOES INTO REVERSE BY ITSELF

If your tiller goes into Reverse by itself, here's all you do to correct it:

With two 9/16” wrenches (as shown in Photo 7/29), loosen the lock nut on the bottom of the reverse adjustment bolt. Then, adjust the bolt *upward* (counter-clockwise). This adjust-

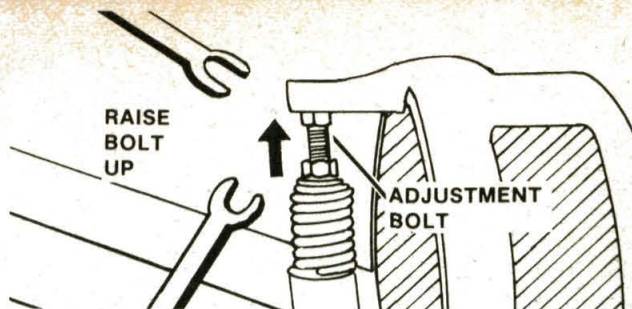

(Sketch 7/25A) If lever doesn't “pop” out of reverse, RAISE Adjustment bolt up until lever does “pop” out of reverse when you let go!

ment widens the gap between the reverse disc and the transmission pulley to the desired distance.

If it takes too much upward pressure to hold the lever in Reverse, or if your tiller will not Reverse at all, then turn the reverse adjustment bolt *downward* (clockwise) until your tiller “pops” out of Reverse when the lever is released, but does not require exceptional strength to hold it in Reverse. While you are adjusting the reverse adjustment bolt downward, make sure that the plunger inside the heavy spring is not turning with the bolt. If the plunger turns, hold it with a pair of pliers so that you can thread the bolt further in the threaded hole—see Photo 7/30. When you have found the proper reverse adjustment on the adjustment bolt, hold the bolt in position with one wrench and turn the lock nut below it to lock it in that position.

REVERSE DISC AND LOWER PULLEY ALIGNMENT

The reverse disc should rest directly over the center of the groove in the lower pulley. The lower pulley has a tiny amount of “float” built into it so that it can move back and forth between two snap rings to automatically center itself when it is driven by the reverse disc—see **B** in Photo 7/26.

If the pulley will not easily move a tiny fraction of an inch back and forth, squirt some penetrating oil on the shaft behind the lower pulley (shown at arrow **B**). The oil should free the pulley. Follow that up with a little lubricating oil.

If proper alignment between the reverse disc and the pulley is *still* a problem after you get the pulley free, check the reverse disc for unusual wear on the front and back edge, or even for nicked and broken edges—see Photo 7/31. You may have to replace the disc with a new one or shim the upper pulley or reverse disc from the front or the rear. See the instructions below for procedures to shim up the reverse disc or to change or replace a new disc.

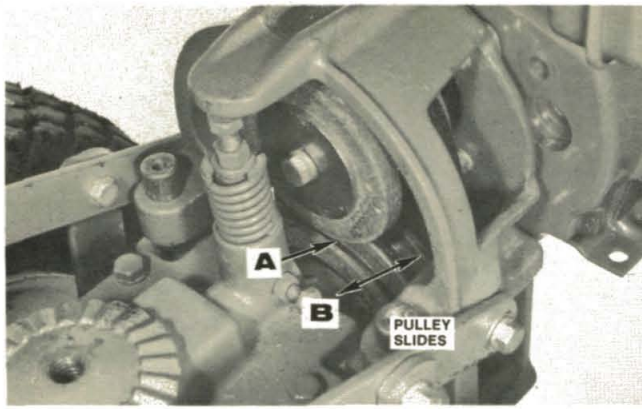

(Photo 7/26) With clutch lever in neutral.

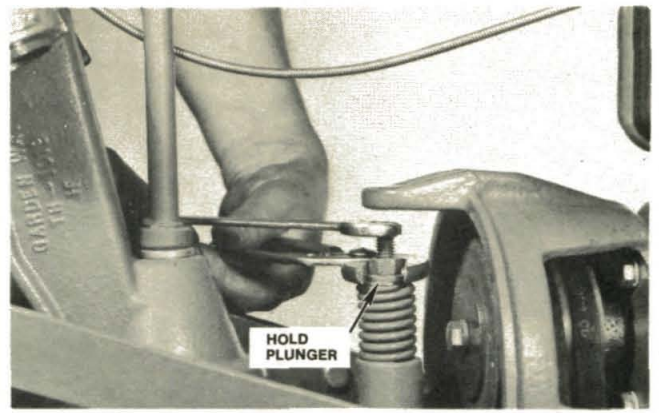

(Photo 7/30) If plunger turns, hold with pliers.



(Photo 7/27) Hold clutch lever in reverse.

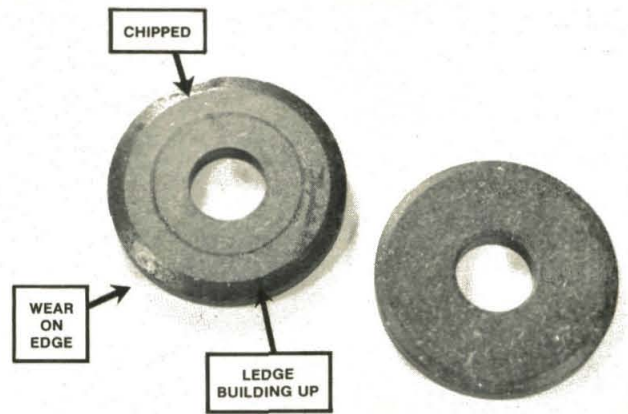

(Photo 7/31) Check condition of reverse disc.



(Photo 7/28) With clutch lever in neutral.

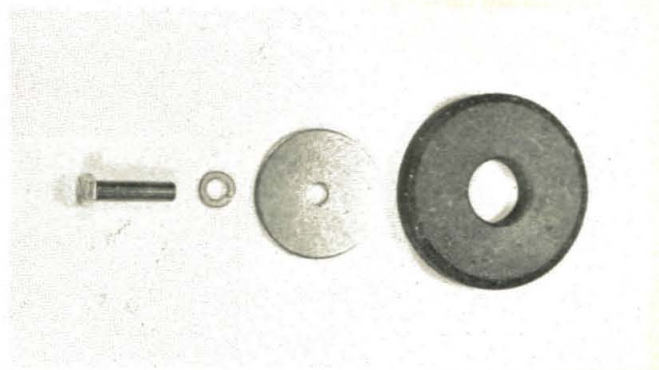

(Photo 7/32) Mounting bolt, lockwasher, mounting plate, and fiber reverse disc.



(Photo 7/29) Loosen locknut on adjustment bolt.

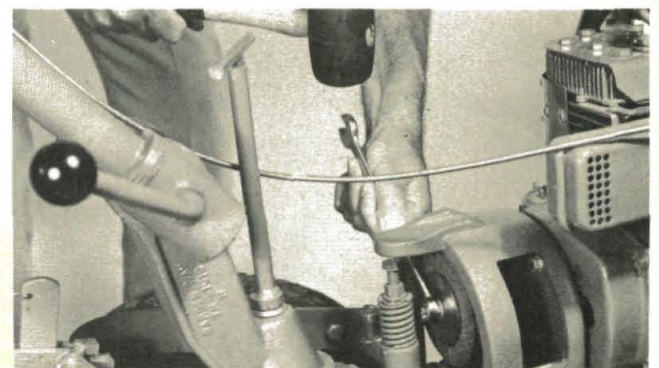

(Photo 7/33) Loosening upper pulley bolt.

REVERSE DISC REMOVAL AND REPLACEMENT

Improper alignment of your disc and pulley causes uneven wear and noise. It will require early disc replacement. Often, when the disc is misaligned, the operator must exert undue upper pressure to hold the lever in Reverse. The reverse disc is made of an asbestos fiber similar to that used in brake linings; it will normally wear out with use.

HOW TO REMOVE THE REVERSE DISC

1. Turn the engine off and shift the Forward/Reverse Lever into FORWARD position.
2. Loosen the bolt for the reverse disc mounting plate by placing a 9/16" closed-end wrench on the bolt and giving the wrench a sharp tap downward with a mallet—see Photo 7/33, Page 104. Remove the bolt, mounting plate and the reverse disc. If necessary, wedge a hammer handle, a screwdriver, or a small board between the upper or lower pulley and the motor mount to loosen the disc mounting bolt. This will prevent pulleys from turning. Remove the disc as shown in Photo 7/18.

PLEASE NOTE: After you install a new reverse disc, take the following steps to "break it in" properly. Place the depth regulator in travel position to keep the tines off of the floor. Put the Wheel Speed Shift Lever in Free Wheel position and start the engine. Then, using the Forward/Reverse Lever, lower the reverse disc into the pulley groove and up into Neutral several times. This will form a glaze on the reverse disc which will minimize further problems.

If you are removing or replacing the disc because you have an alignment problem, look carefully at both edges of the disc—see Photo 7/31. Severe wear on the edge nearest the engine, but no sign of wear on the edge closest to the operator, means that the reverse disc is not quite far enough away from the engine. A small shim or a second part #1073 (early) reverse disc face plate behind the disc will move it forward enough to get the proper alignment.

If your reverse disc shows exceptional wear on the edge facing the operator, you must remove the engine pulley and take out a shim that is behind the engine's pulley. The shims behind the engine pulley are usually about 1/16". In this instance, a shim behind the pulley of half thickness would suffice. The inner diameter of shims (part #1138) is 49/64 inches.

NOTE: On a tiller that has had twenty-five or more hours of use, if the upper pulley can't be aligned with the lower pulley (part #1008-1) properly, it could be that the main drive shaft has become loose. (See page 134 for "How to Shim the Tiller Transmission Drive Shaft.")

To remove one shim or more from behind the engine pulley (part #1007-1), here are the steps you will have to take. First, you probably have already removed the mounting bolt securing the reverse disc and the engine pulley as described in Step 2 above and shown in Photo 7/33. If not, remove the bolt and the reverse disc.

After you have loosened the pulley mounting bolt, remove the belts (refer to belt changing instructions on page 99 of this section). With the reverse disc removed, take out both motor mount bars (part #1034) by backing off the bolt **B** (shown in Photo 7/34) and tapping the bar down with a hammer and a 1/2" rod or dowel (as shown in Photo 7/35). With the motor mount bars and belts removed, it will be possible to lift the motor mount and the engine off the tiller. Please refer to "Removing the Engine from the Troy-Bilt Horse Model" on page 148 for detailed information.

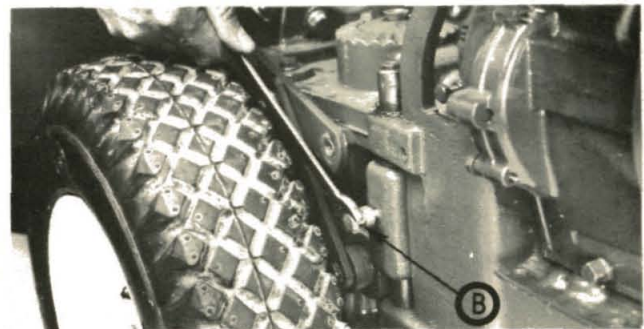

(Photo 7/34) Back off motor mount bar bolt **B**.

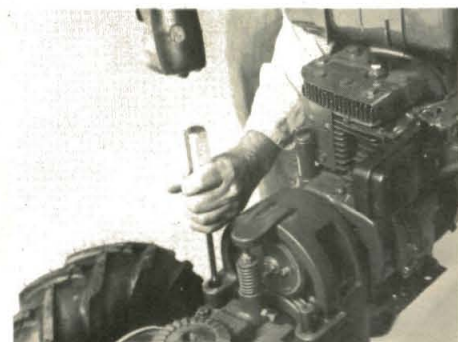

(Page 7/35) Tap bar down and out.

When the engine and the engine mount are removed as an assembly, you can turn your thoughts back to the reverse disc alignment problem. Next, remove the engine pulley by putting a pry bar or a large screwdriver through the opening in the motor mount, as shown in Photo 7/36, and tap the bar toward the front of the engine to loosen the pulley. When it is loose, carefully take the pulley off the engine power takeoff shaft.

REMOVING ENGINE PULLEY SHIMS

As you remove the engine pulley (part #1007-1), take careful note as to how many shims (thin washers) are between the pulley and the engine. Write down the number of shims between the end of the engine crankshaft and the pulley—see Photo 7/37. The written note will help you return to the original shim distance, if desired. There may be one, two or three shims used. If you add a shim behind the pulley, it will move the pulley toward the operator by the thickness of the shim. If you take out a shim, it will move the pulley toward the engine.

Replace the shim behind the pulley (with a thinner one, or none at all, if need be) and then put the pulley in place and tap the key back in the pulley (Photo 7/38). Clean off the motor mount bars and grease them lightly. Lift the engine and place it back into position.

Then, insert the bars in the top hole of the motor mount. As soon as a motor mount bar gets through the lower hole, stop tapping it down. Then, back off the jam nut and install the locking bolt for the bar. Turn it until it is finger tight and you feel it strike the bar. Take a wrench and apply a very slight pressure on the bolt while you continue to tap the bar down—see Photo 7/39. When the groove in the bar reaches the bolt, the pressure on the bolt will be relieved. Thread the bolt all the way in. Then, back the bolt off one-half turn and lock the jam nut with a second wrench while you hold the bolt in position. Install both engine mount bars.

Next, replace the belts and the reverse disc.

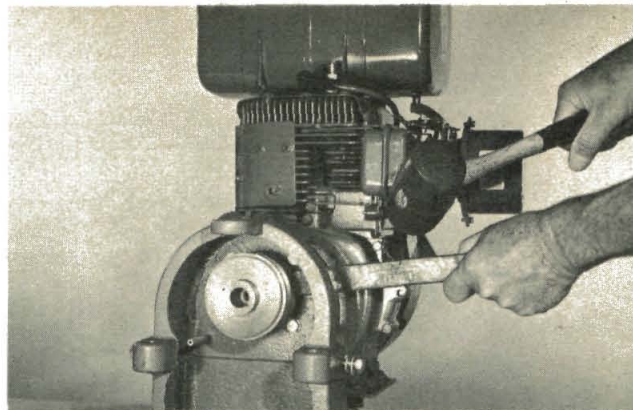

(Page 7/36) Loosening engine pulley.

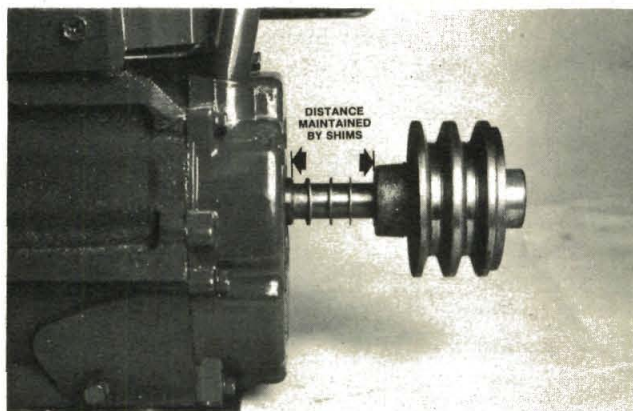

(Photo 7/37) Shims between pulley and engine.

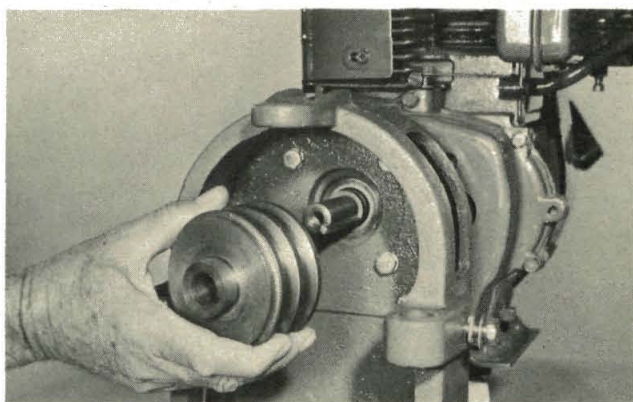

(Photo 7/38) Replacing the engine pulley.

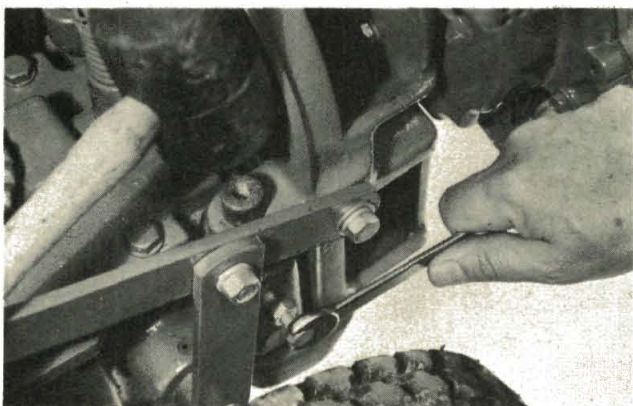

(Photo 7/39) Keep pressure on bolt and tap bar.

6 HP TECUMSEH-LAUSON ENGINES

Put on the disc mounting plate and the pulley mounting bolt. Secure the bolt tightly. Check out the disc and lower pulley alignment, **reverse** operation and belt tension.

If you have any problems whatsoever in aligning your reverse disc or getting proper shims, or understanding which way to shim the reverse disc to get the proper clearance, please get in touch with us right away here at the factory. We will send you the proper shims and give you further instructions to help you get the proper alignment.

While you're replacing the reverse disc, take the time to use the oil can on the lower pulley to keep it lubricated. Also, make sure that all of the linkage for the Forward/Reverse Lever is well oiled and lubricated.

If the reverse spring adjustment (described on page 103 of this manual) does not result in a properly functioning Reverse, please check these points: Make sure that new belts have had an hour or two of tiller operation to "break in" before going any further. Check the alignment of the reverse disc and the lower pulley. Inspect the reverse disc for wear or damage.

If these checks have not determined a cause for your improper reverse action, please write to us at the Service Department in Troy, New York and let us know the difficulty and what you have tried to correct it. If it's urgent, call us on the telephone. [The number is (518) 235-6010. Ask for the Service Department.]

THROTTLE CABLE HOOKUP, ADJUSTMENTS, AND MAINTENANCE

Even though your Tiller's throttle cable was hooked up at the factory before it was shipped to you, it may need adjustment at a later time.

For instance, your engine could be difficult to start or stop, or it may not respond immediately when you move the throttle lever. Such symptoms could be due to a need for throttle cable maintenance or replacement. There's no need to put up with this sort of nuisance. Now, you can learn how to make proper adjustment easily for the best Tiller performance.

Photo 7/40 shows the throttle cable and its casing running right down the handlebar and crossing over to the engine. At the engine, the casing is fastened with a mounting clip and the throttle wire continues over to attach to the remote speed control lever. A close-up of these connections is shown in Photo 7/40A.

On all Troy-Bilt Horse Model Tillers, the throttle cable has been clamped to the handlebar with two spring clips—see Photo 7/40. On all engines, *engine shut-off* and a full range of engine speeds can be selected remotely by moving the speed control lever on the handlebar—see Photo 7/41.

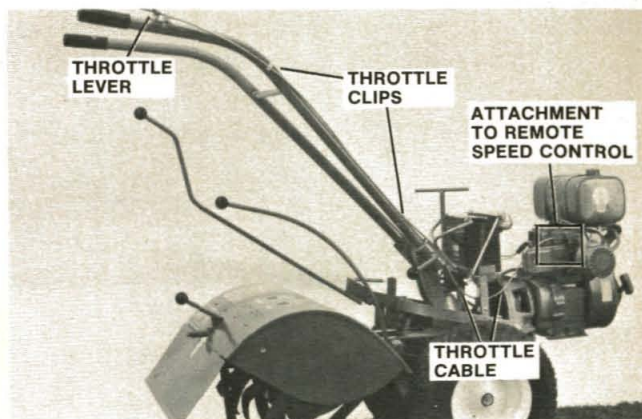

(Photo 7/40) 6 HP engine with throttle cable.

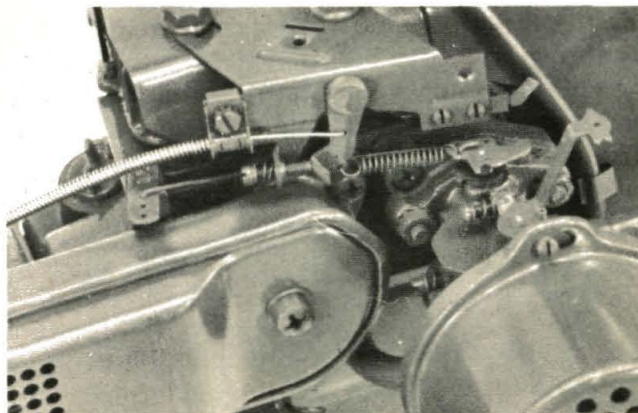

(Photo 7/40A) 6 HP throttle cable hook-up.

When the speed control lever on the handlebar is all the way forward, the engine shuts off by touching a short-out clip. See Photo 7/42.

In between *engine shut off* and *high speed* is the full range of the throttle speed. If you move the lever to the left (back) the engine runs faster. Moving it to the right (forward), makes the engine run slower, or stop.

NOTE: Occasionally, through normal use, throttle cables become "kinked," from being twisted or snagged in some way, caught on something, or bent when the tiller handlebars bump against some obstruction. Rarely, if ever, can cable "kinks" be straightened properly to give satisfactory positive throttle control. If you have a badly kinked cable, you'd better order a **new** throttle cable wire from us at the factory. Please use your Troy-Bilt Parts Order Form to do so, and include the make and horsepower of your engine.

ADJUSTING THROTTLE CABLE ON THE 6HP ENGINE

To adjust your throttle cable (if you don't get engine *shutoff* by moving the lever on the handlebar), loosen but do not remove the clamp (as shown in Photo 7/40B, arrow **A**). Just move the speed control lever on the handlebar all the way forward toward the engine. Then, move the casing and all so that the remote speed control lever makes contact with the *shutoff* clip (Photo 7/42, arrow **E**), tighten the clamp, holding the casing at arrow **D**.

Now, try the lever on the handlebar once more. All the way back is *full speed*. All the way forward should be *shutoff*. Idle and slow speed are in between.

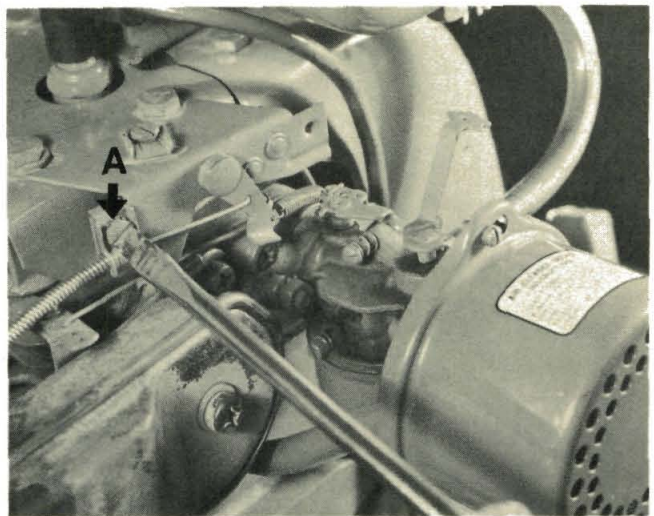

(Photo 7/40B) 6 HP remote speed control.

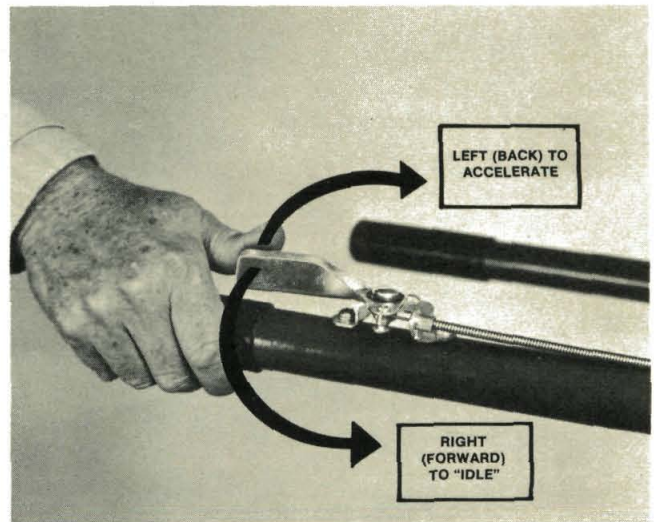

(Photo 7/41) Throttle Lever.

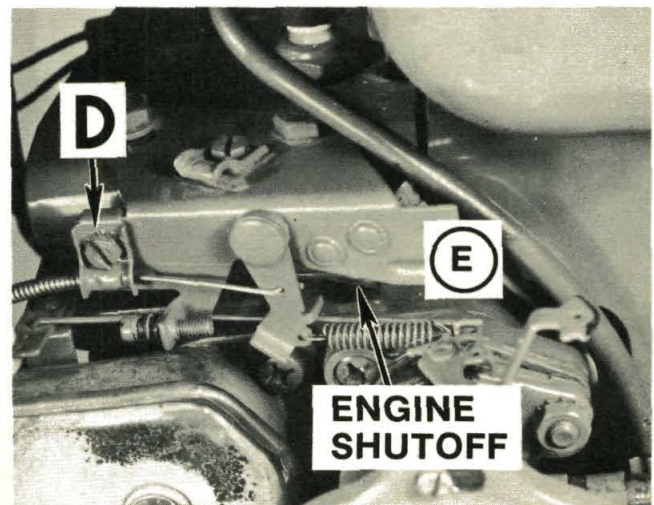

(Photo 7/42) Adjusting throttle cable—6 HP.

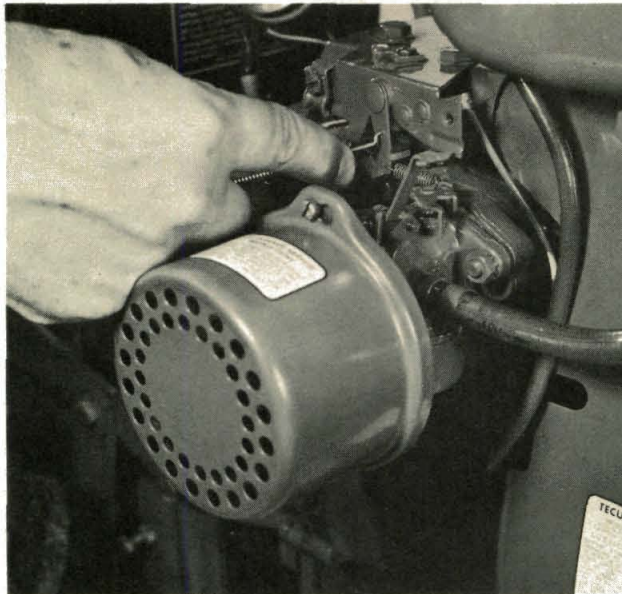

(Photo 7/43) Connect wire to speed control lever.

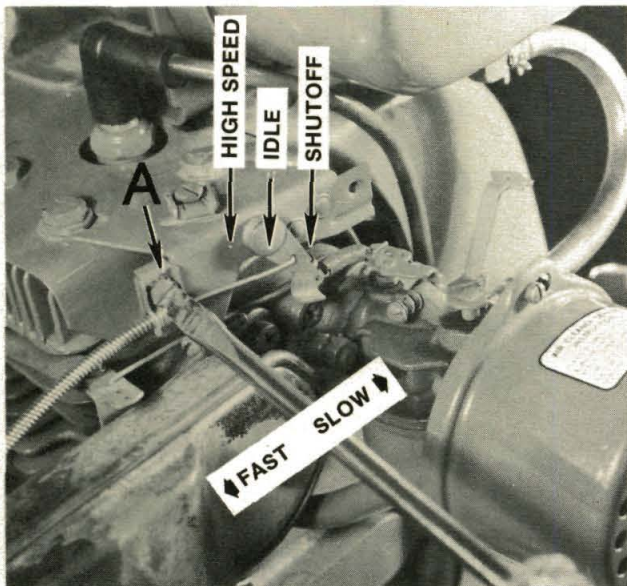

(Photo 7/44) Allow overhang (6 HP).

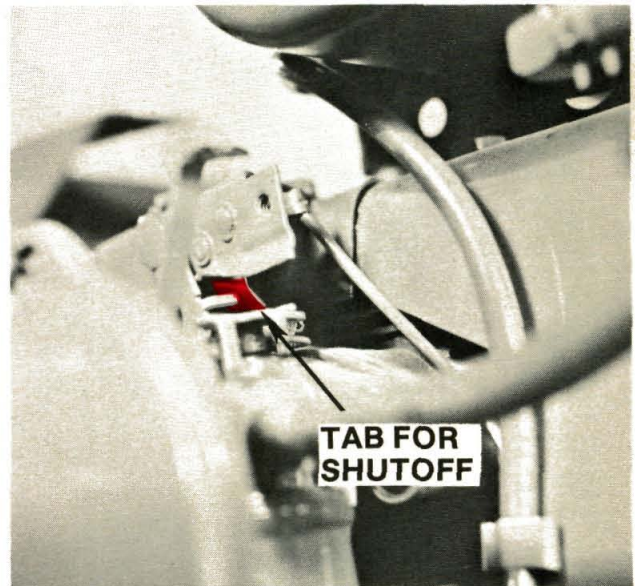

(Photo 7/45) Throttle control touches tab.

TO INSTALL A NEW CABLE

Lay the throttle cable casing down the length of the handlebars to the remote speed control lever (shown in Photo 7/40).

On the standard recoil start or electric start engine, route the throttle cable straight down the handlebar. Put one cable clip above the top

bend of the handlebar and one clip about 10 to 12 inches above the height adjustment stud.

Connect the crimped end of the throttle wire at the remote speed control as shown in Photo 7/43. Then, place the cable in the clamp shown in Photo 7/44 and tighten the clamp. Now, test the cable for proper throttle and shutoff settings—see Photo 7/42 and 7/45.

CABLE HOOK-UP AND ADJUSTMENT FOR 7 HP KOHLER ENGINE

There really isn't very much adjustment required on the throttle cable for your 7 HP Kohler engine. Once it is properly hooked up, all you're likely to require is some regular maintenance, such as making sure that the full length of the throttle cable is oiled and well lubricated. Be sure to squirt some oil inside the casing at both ends. Then, make sure that the clamp screw is tight and in the proper position so it doesn't permit a bend in the wire to occur. See Photos 7/46 and 7/47 for the correct throttle wire connection to the governor control disc.

When hooking up a new throttle wire (or replacing your old wire after engine removal) make sure the wire doesn't take an extreme bend. You should connect the wire in the first practical hole of the disc. You'll note that the full range from low speed to high speed is covered with very little throttle lever movement. So keep that in mind while operating your Troy-Bilt. The 7 HP Kohler engine "lugs" along very well at relatively low speed—that is it provides quite enough power to do most tilling jobs at relatively slow engine speeds. It sounds like the engine is operating so quietly that you hardly realize that it is doing so much work so easily.

7

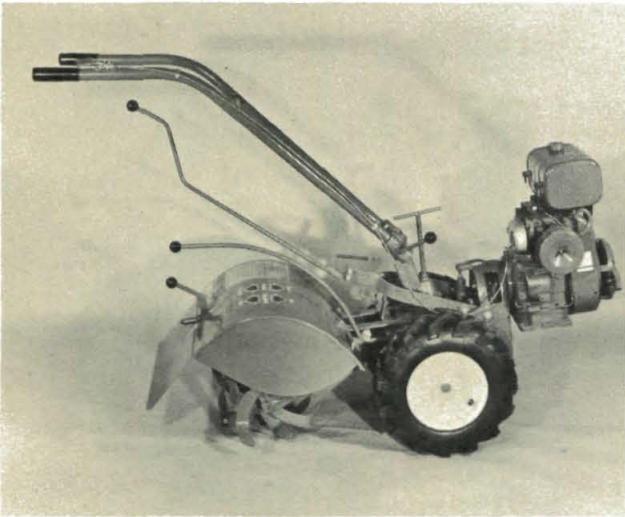

(Photo 7/46) Throttle cable on 7 HP tiller.

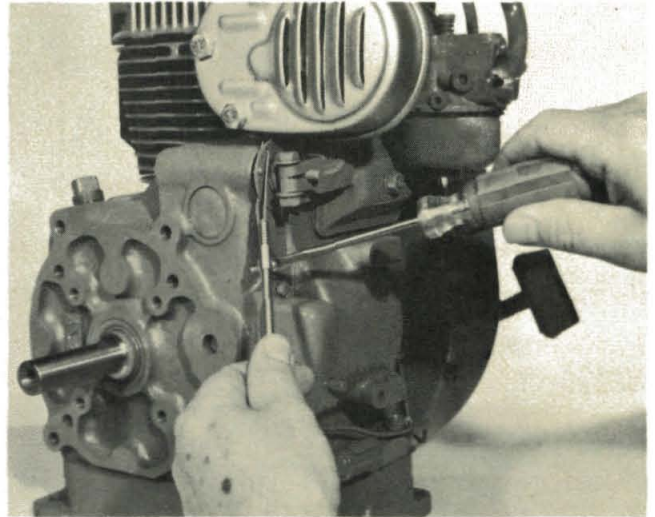

(Photo 7/47) Put wire in nearest hole.

NOTE: For both the 6 H.P. Tecumseh-Lauson and the Kohler engines, clips are not designed to fit all the way around the handlebars.

Since your throttle wire connects directly onto the governor control disc, you should be alert to the fact that the nut and bolt clamping the governor arm (in Photo 7/47) should not be loosened or fiddled with. It takes a trained serviceman to readjust a governor if you loosen that bolt or the wide nut in front of the governor control disc. So please don't fool with them unless you get some knowledgeable help first.

Just make sure the throttle cable is lubricated on that end. A rusty throttle cable is the most common reason for having to put too much pressure on the throttle lever to move it—which ultimately leads to a bent wire and the start of tinkering with the governor linkage.

PERIODIC LUBRICATION

Frequent lubrication of the throttle cable works wonders. Remember to oil the throttle cable regularly with engine oil, grease, silicone oil spray, or graphite. All work well. Brush or spray the lubricant on the entire length of the cable casing. Lubricate the external moving linkages of the throttle lever, speed control and governor assembly.

Lubricate them at least every few times you go out with your tiller—at least once every few weeks. Lubrication of the throttle cable components prior to winter storage can also be quite helpful in the performance of your tiller in the spring.

QUICK ENGINE MAINTENANCE REMINDERS

1. Engine Oil

- Use SE rated oil right from the start.
- Check the oil level and make sure it is clean.
- Check the oil level with the dipstick prior to each use of the tiller.
- Check the oil level every 2 hours, if you are tilling all day long.
- Check the oil in the engine every 10 hours or less.
- In dusty conditions, change the oil whenever it becomes dirty.

2. Check and service the air cleaner frequently. Every time you till for more than 1 hour, check the air cleaner at intervals during tilling.

3. Clean the debris from the cooling fins on the engine.

4. Check the governor and carburetor linkages for operation and ease of movement. Oil them occasionally.

5. Inspect the spark plugs.

6. Check the carburetor and air cleaner fit for tightness and good gaskets. Make sure that there are no movements, indicating looseness.

7. Check gasoline for presence of water.

8. Inspect the engine shroud for dents or interference with the flywheel.

9. Engine power loss (not due to faulty carburetor adjustment or bad fuel):

- Check the engine compression immediately after the engine stops running. Pull gently on the starter rope to feel the compression.
- Where there is a loss of compression, check for a sticky valve or valve lifter, or for loose head bolts or a blown gasket. See an authorized service dealer.
- Have the compression tested for suspected worn rings.
- Worn rings can be caused by dirty oil or a dirty air cleaner.
- Don't use non-detergent oil for long periods, then switch to detergent oil. Use SE rated oil right from the beginning. Prolonged use of non-detergent oil prior to use of detergent oil can cause excessive ring wear.

IMPORTANT SERVICE MESSAGE ABOUT ALL ENGINES

HOW TO GET THE VERY LONGEST ENGINE LIFE

1. CHANGE THE OIL **MORE OFTEN** THAN RECOMMENDED BY THE ENGINE MANUFACTURER!
2. SERVICE AIR CLEANER REGULARLY!
3. KEEP THE ENGINE COOLING FINS **FREE FROM DIRT AND DEBRIS!**

It is important to change the engine oil more often than the engine manufacturer recommends, to regularly check and service the air cleaner, and to always clean away dirt and debris from the engine cooling fins, if you want to get the very LONGEST life from your Troy-Bilt Tiller Engine and avoid costly engine repairs.

Unlike other engine driven equipment around your home, your tiller will be used under the *most adverse* operating conditions, often for extended time periods, with continual exposure to abrasive, dry dust, dirt and small particles. All of this can enter your engine cylinder and crankcase through the air cleaner if you do not service it regularly.

Dirt coming in through improperly installed or poorly serviced air cleaners can wear out an engine much sooner than many long hours of tiller operation. Your engine consumes about 8,000 gallons of air for every gallon of gasoline it burns. With that kind of ratio, it's just common sense to keep the air cleaner clean.

Dirty oil also causes engine failure. Please change the oil every 10 operating hours—or even sooner if conditions are dry and dusty. Section 4 of this manual gives directions for changing oil for the first time on a new engine. Use clean oil of a good quality that is rated SE or SD by the American Petroleum Institute (API). Look for the rating stamped on the top of the can or printed on the label. Also, for tilling, be sure the oil is No. 30 viscosity, if available, or 10W-30 multi-viscosity.

CLEAN COOLING FINS

In order to keep your engine cool, it is important that the cooling fins on the engine be cleaned to remove all dirt and debris. If your engine becomes overheated due to obstructed air fins, it could cause serious damage to the engine.

IF YOUR AIR CLEANER IS THE POLYURETHANE (PLASTIC SPONGE) TYPE:

Check the air cleaner for cleanliness before using the tiller each time. Check it at least every two hours during operation if you are tilling for long periods, or even every half hour if conditions are extremely dusty. If the sponge is dirty, here's how to clean it:

Remove the element (as pictured in Photo 7/47A). Wash it by squeezing it in a detergent and water solution, or a solvent such as gasoline, kerosene or mineral spirits. It's just like a sponge. Rinse it, and squeeze out the cleaning solution. Then re-oil it by applying about two tablespoons of motor oil to the element. Work it into the element. Squeeze out any excess oil and wipe it off with a paper towel or clean cloth. Then put the element back in the case.

If kept clean, polyurethane elements will last almost *indefinitely!* But, when they can't be cleaned anymore, replace them with an air cleaner element (Tecumseh part #31700) which can be obtained at the Tecumseh Service Dealer's shop or from our Parts Department.

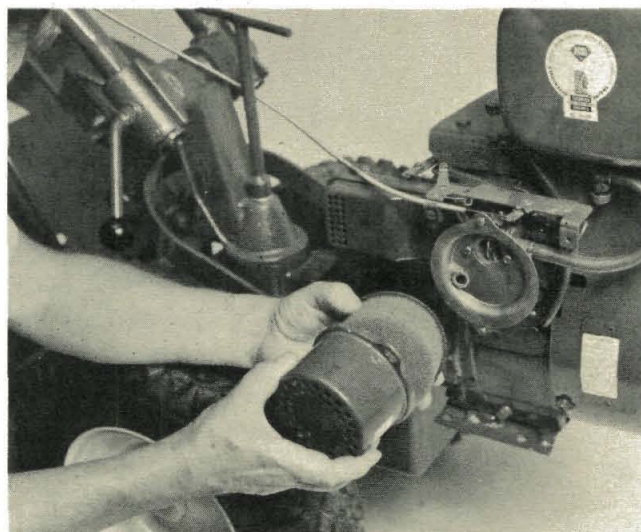

(Photo 7/47A) Clean the air cleaner.

IF YOUR AIR CLEANER IS OF THE DRY ELEMENT TYPE (7 HP ONLY):

Check the element at the start of each day that it is used, and at least every 2 hours of operation when it is used continuously. Vacuum clean the element after every 10 hours of operation. Change it every 50 hours, or whenever it can't be cleaned, or if it is torn—see Photos 7/48 and 7/49. Refer to the *Kohler Engine Owner's Manual* for instructions (page 5) on servicing and removing the air cleaner.

FOR ALL ENGINES

HOW TO ADJUST THE CARBURETOR TO CORRECT POOR TILLER PERFORMANCE (DUE TO ENGINE STALLING, SPUTTERING, SMOKING, OR TO LOSS OF ENGINE POWER).

If you abruptly open the throttle, especially after the first few hours of operation, your engine might happen to “stall,” “sputter,” or “skip.” This could mean one of several things. It could result from a cold engine, a dirty air cleaner, an improperly adjusted Idle Adjustment Needle (rare), or more likely, a fuel-to-air mixture that is too rich.

In either situation the adjustments are simple. First, make sure that your air cleaner is not clogged up with dirt. Clean it if it is. Do this before you ever make any adjustments on your carburetor. Also, make sure that the spark plug is clean, properly gapped and its porcelain is not cracked.

The carburetor adjustments are simple too; just take the steps below.

Please refer to the photo of the carburetor on your engine as you read these instructions (see Photos 7/50 for the 6 H.P. and 7/51 for the 7 H.P. engine).

First, find the *power adjustment screw* which is located at the bottom of the carburetor bowl (see **A** in the photo) for the 6 H.P. engine and on the top of the carburetor for the 7 H.P. engine.

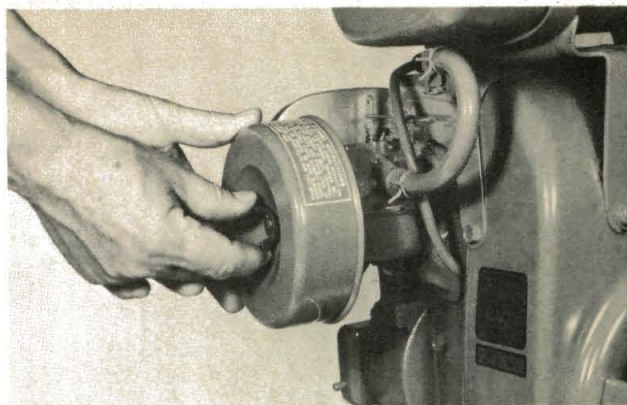

(Photo 7/48) Remove wing nut.

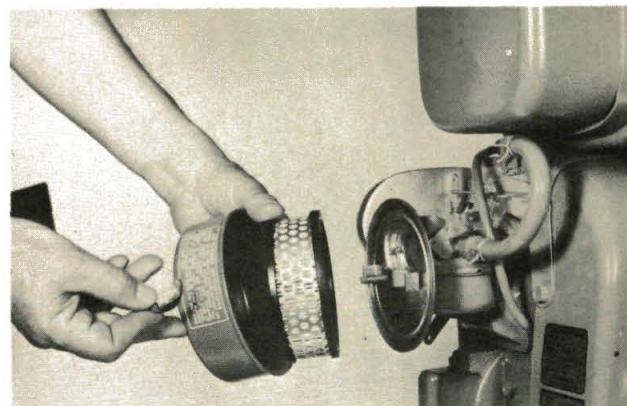

(Photo 7/49) 7 HP engine. Clean the paper element.

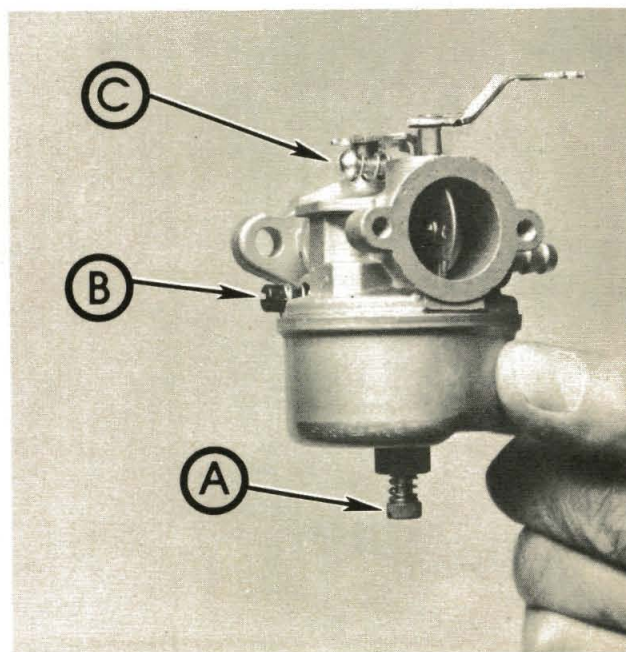

(Photo 7/50) 6 HP engine carburetor.

On the 6 H.P. engine, it is set in the center of the hex nut that holds the bowl in place. On the 7 H.P. engine it is on top of the carburetor.

Power adjustment screw **A** regulates the fuel-to air mixture for *high speed* or power. If the mixture is too rich or too lean, no engine will run properly. An engine cannot develop *all* of its power unless it is properly adjusted. Keep the throttle wide open during adjustment.

Therefore, adjust **A** by turning it to the right, *clockwise* (see Photo 7/50) one-eighth to one-quarter ($\frac{1}{8}$ to $\frac{1}{4}$) turn more for a *leaner* mixture ...or to the left, *counter-clockwise* one-eighth to one-quarter ($\frac{1}{8}$ to $\frac{1}{4}$) turn for a *richer* mixture.

Please remember to pause for 10 to 15 seconds after each adjustment to determine how the last adjustment changed engine operation.

If your engine seems to have enough power before you start tilling, and then loses power the minute you engage the tines deeply in the soil, it probably means that you have to open the power adjustment screw with about a $\frac{1}{4}$ to $\frac{1}{2}$ turn (counter-clockwise).

7

ADJUSTING THE POWER ADJUSTMENT SCREW

To determine the proper power adjustment screw setting, run the engine at full power (without choke engagement) and open the power adjustment screw (**A** in Photo 7/50 or 7/51) counter-clockwise until you see black smoke or notice the engine "coughing." Then, counting the number of turns, turn the screw back towards *lean* (clockwise) until the engine slows down or sputters. Then, go back counter-clockwise half way between the two positions. That final position, or $\frac{1}{2}$ turn further counter-clockwise, should be the proper setting for tilling. You might find in actual tilling that you still have to open up the screw another $\frac{1}{2}$ turn for enough power. But don't run the engine so richly that it smokes—normally, you won't even see the exhaust.

IDLE SPEED ADJUSTMENT

To *increase* the idling speed of the engine, turn screw **C** to the *right*. Turn it to the *left* to decrease idle speed (see **C** in Photo 7/50 or 7/51).

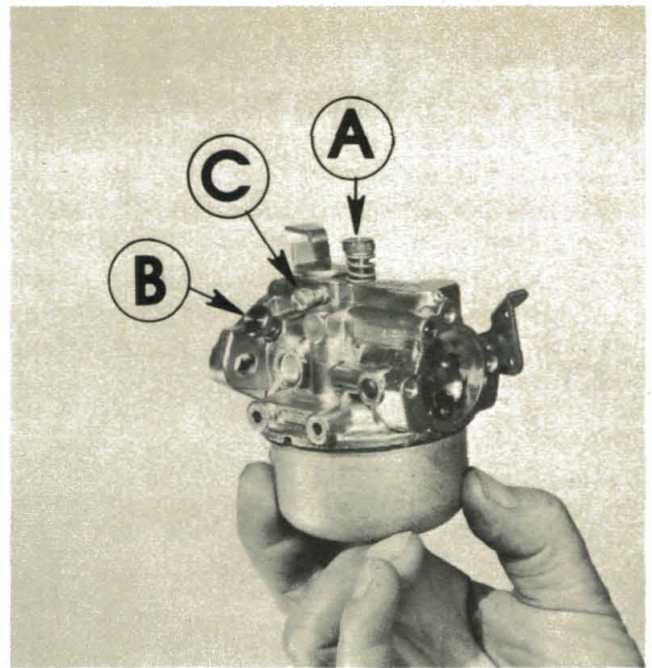

(Photo 7/51) 7 HP engine carburetor.

IF YOUR ENGINE WON'T START

When you can't start your engine to readjust the carburetor, you should return the power adjustment screw back gently to the original setting as described on page 115.

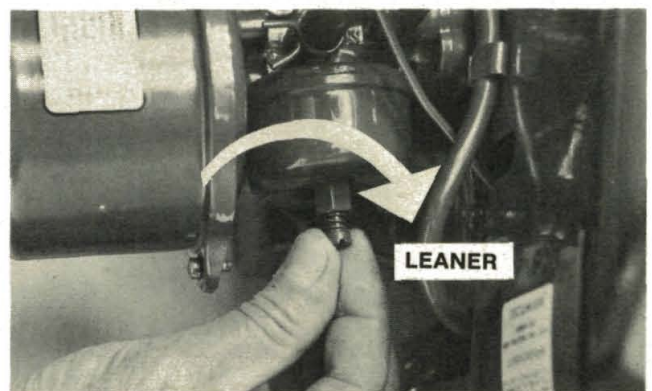

(Photo 7/52) Turn clockwise to lean fuel mixture.

IDLE ADJUSTMENT NEEDLE

Make sure that the speed control lever is in *slow* or *idle* position before adjusting this screw (needle). Also, please don't tinker with it—it normally is set properly (see **B** in Photo 7/50 or 7/51).

One way to tell if the idle needle needs adjustment is to move the throttle lever abruptly from the *idle* position to *fast speed*. If there is a hesitation or "miss" before the engine goes into high speed, the idle adjustment needle can be opened up (counter-clockwise) until the engine runs smoothly in idle and does not pause when the throttle is opened abruptly. Once you have adjusted the idle adjusting needle (allowing the engine to react to the change) and have it idling smoothly, recheck the adjustment on the power screw setting. It may need to be readjusted.

It is true that every single engine is tested at the manufacturer's factory and that the carburetor is properly adjusted and set for good operation before shipment. But even so, the power adjustment screw **A** cannot be guaranteed to be 100% right—because of variation in locality and atmospheric pressure (due to differences in altitude)—besides the necessary hours the engine needs to "break in."

ENGINE WON'T RUN AT ALL—SETTING THE POWER ADJUSTMENT SCREW BACK TO THE ORIGINAL SETTING

6HP Tecumseh:

1. Turn clockwise towards *LEAN* carefully until it stops. **DO NOT FORCE, OR YOU WILL DAMAGE THE NEEDLE AND SEAT.**
2. Turn counter-clockwise (open) for one full turn. This should be close enough to operating position to start the engine.

7 H.P. Kohler:

1. Turn clockwise towards *LEAN* carefully until it stops. **DO NOT FORCE, OR YOU WILL DAMAGE THE NEEDLE AND SEAT.**
2. Turn counter-clockwise (open) 1½ turns. This should be close enough to operating position to start the engine.

OTHER THINGS TO REMEMBER

Please allow 10 to 15 seconds between each adjustment for the engine to react to new settings.

Also, look for clean exhaust (no black smoke) as further evidence that your carburetor is set *just right*.

If these adjustments do not get the engine running smoothly again, study the engine maintenance manual you received with the tiller. It covers engine operation and service in *greater* detail.

If you need further help, please contact your nearest authorized service dealer for your make engine. You'll find him listed in your telephone directory *yellow* pages. Or write to us at the factory, if you prefer. We'll put you in touch with your nearest authorized dealer, and also do *anything else we can* to help you get it fixed *right!*

Please remember, proper care and attention at regular intervals only takes a few minutes. It's the best investment you can make to assure longest possible life and trouble-free service. Your engine is of the best construction, all cast iron, precision built for long life. It deserves the best care.

NOTE: Adjusting screw **B** (shown in Photo 7/50 or 7/51) affects the idle mixture only. Please do not tinker with it unless you want it adjusted.

Adjusting screw **C** (shown in Photo 7/50 or 7/51) affects only the idle speed. Only change its setting if you want to make the engine idle faster or slower. The screw holds the throttle open a little for idle, threading it inward makes it idle faster.

CLEANING OUT DEBRIS AND INSPECTING THE ENGINE

Regularly inspect the engine and clean out dirt and debris from in between the engine's cooling fins on the top and on the side facing the operator—see Photo 7/53. Particularly make sure that the hole above the governor lever is free from dirt and debris.

Look over all of the throttle and governor linkages to make sure that they are free to move easily in order to perform their control functions properly. With the throttle lever in the off position, work the governor lever back toward the

operator position several times to see that it is free to move (as shown in Photo 7/54).

Notice, at this time, that the governor spring completely relaxes its tension when the throttle closes completely. Also, watch the action of the governor spring when you open the throttle on the handlebar. As you begin to go faster than idle speed, the tension on the spring will increase and therefore open the throttle shutter on the carburetor.

Check the action on the carburetor's choke. Moving the spring in toward the engine should close the choke completely. When you let go, it should spring back by itself. Make sure that the throttle wire is free to move the full length of the throttle cable. Apply some oil over the cable's entire length to make sure that it remains free.

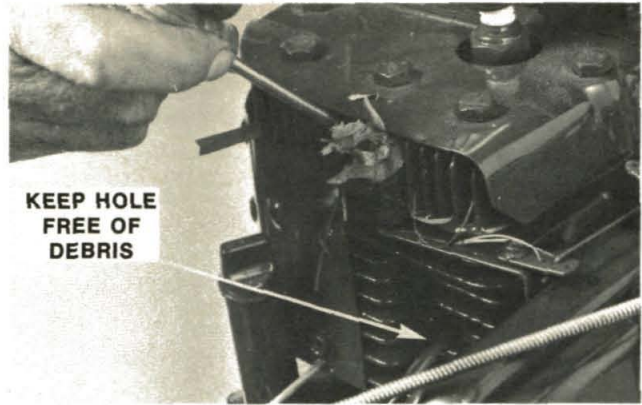

(Photo 7/53) Clean cooling fins.

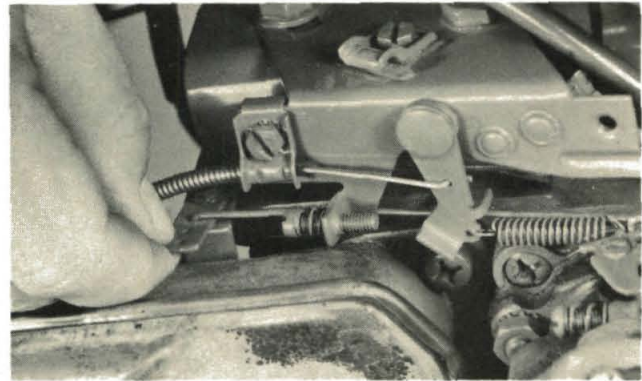

(Photo 7/54) Check governor lever freedom.

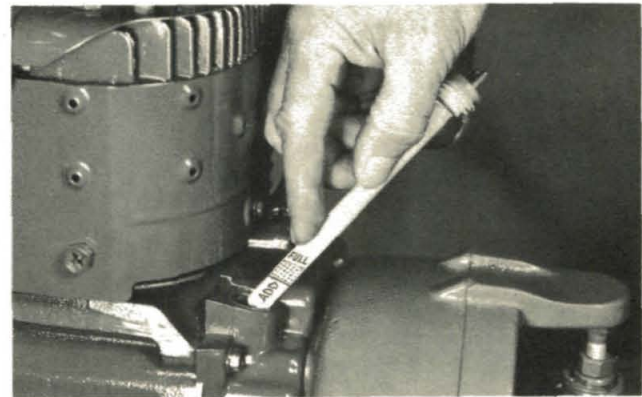

(Photo 7/55) Check oil level on 6 HP engines.

THE ENGINE CRANKCASE BREATHER

If your engine constantly needs replacement of oil, or if oil constantly drips from your sponge air cleaner after the engine stops, one source of the trouble could be the crankcase breather.

First, make sure that your engine oil level has not been overfilled. On new 6 H.P. engines, make sure that you fill the engine oil only up to the *full* mark of the dipstick (see Photo 7/55) when the tiller is in its normal sloping position at the travel setting (that is, with the depth regulator up to the top notch and the tines just a few inches off the ground) for dipsticks marked 65 or 55.

If instead of having the depth regulator properly set, you have leveled out the engine base and filled the oil up to the *full* mark with a new engine, you have overfilled it with oil. This oil will be drawn up through the breather into the air cleaner where it will drip out. However, either a faulty functioning reed valve in the breather, or dirt in the breather could cause the same conditions.

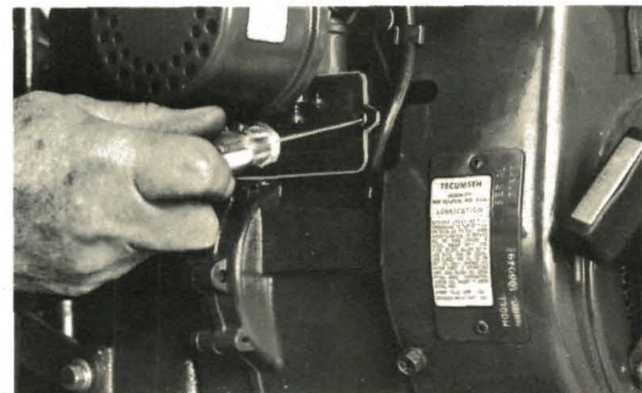

(Photo 7/56) Remove valve cover, check breather.

It is a simple matter to check and see if your crankcase breather has been clogged with oil and has not been able to function properly because of it. Underneath the carburetor you will see (Photo 7/56) that there is a plate fastened to the side of the engine with two Phillips screws. It has a rubber hose coming out of it leading directly up to the air cleaner. This is the valve cover, which also covers the crankcase breather. Removing the two Phillips screws and the plate will reveal the crankcase breather underneath it. **When removing the plate, make sure that you take care not to damage the gasket under the cover. Be prepared to replace it with a new one, if necessary.**

Inside the tub-like steel breather assembly, you will probably find an amount of oil. If you look closely in the bottom center of the breather assembly, you will find a small hole (shown in Photo 7/57). This hole and a hole on the back side, in the left corner, are oil drain holes.

Oil that comes into the breather assembly is supposed to drain back into the engine crankcase through these holes. Therefore, these holes must be kept clean and open so that the oil can return to the crankcase. If they are clogged with dirt, clean them out with gasoline, and see that the sponge underneath is also clean.

CAUTION: Make sure that the breather goes back into the engine with the hole on the bottom. If oil has been dripping from your air cleaner, remove and clean the oil from the sponge. Also clean the excess oil from the air cleaner cover and the air cleaner base before you run your engine again. Then, replacing the cover on the breather assembly with a good gasket and snugly tightening up the screws to allow no air leaks should take care of your problem, if that is all that it was.

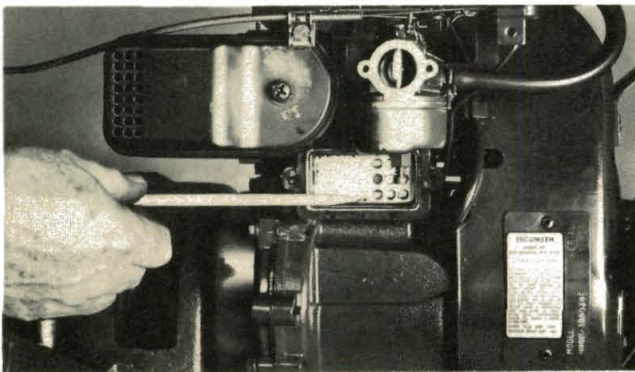

(Photo 7/57) Pencil points to drain hole.

However, if this does *not* solve your problem, get in touch with your authorized engine service dealer to determine whether or not you have problems with your piston rings, or if your engine breather assembly needs to be replaced. Please note that one simple but often overlooked item that can lead to oil breather problems is a badly damaged gasket on the dipstick which makes it impossible for you to tightly seal your dipstick when you thread it in. So, check the gasket to make sure that it is a good gasket and doesn't allow any air to leak in.

CARE AND MAINTENANCE OF THE 12-VOLT ELECTRIC START SYSTEM (6 HP ENGINES)

Never run the engine on a battery electric start system with the battery disconnected or one of the battery terminals disconnected unless you remove the fuse from the system's recharging line and tape the fuse holder—see Photo 7/58. Regularly inspect and check all wires for tightness and to make sure none of the wires touch any bracket, cases or metal parts on the tiller or engine. If you think there is a short in your system, the first thing to look for is all of these wire connections.

Check each cell in the battery for acid level regularly. Don't let the acid level drop below the ledge of each cell. If it does go down, use distilled water to bring it up to level and then run the engine for about ten minutes to help recharge and recirculate the acid.

CHECKING FOR FAULTY KEY SWITCH OR ITS WIRE

If you turn the key switch to start and nothing happens, and you know the battery is adequately charged, test to see if the fault is in the key switch or its wires. Take a short length of heavy insulated wire (#10 or larger) and replace the negative battery cable with it as shown in Photo 1/25. Then, use the battery cable to "jump" the solenoid between the right post and the center post as shown in Photo 7/59.

First, make sure that your Forward/Reverse Lever is in Neutral position, hold the other end of the wire on the insulated portion several inches from the end and touch it firmly to the center post of the solenoid. Make sure that you touch only the end of the post and not any of the side casing of the solenoid.

If the starter motor energizes and tries to start the engine, or in fact does start the engine, then you know that your problem lies within the wires of the key switch or the switch itself.

Perhaps the connection between the wire terminal and the key switch was loose. Check that it is a firm connection. Then use another jumper wire (such as your #10 wire) to jump the wires between the left and right side of the terminal as shown in Photo 1/28. If your starter turns over it tells you that the key switch wires are good and the solenoid is good.

Next, you might remove the key switch from its panel with an adjustable wrench to test the switch itself. Use 1 or 2 flashlight batteries and a bulb to test the switch as shown in Sketch 7/60. When you turn the key to START, the light should light up, as long as your little battery tester wires are securely attached to the battery and bulb.

If you can't get the flashlight bulb to light up then you probably have a faulty key switch. Get in touch with us at the factory and let us know.

If faulty wires or a faulty key switch is not the problem, then you must determine whether or not the solenoid is at fault. Merely disconnect the positive cable from the right side of the solenoid. Then reach around and touch the wire to the starter button post on the left side of the solenoid— see Photo 7/61. If that energizes the motor or starts the engine, then you have a faulty solenoid. A replacement can be obtained from the Parts Department at the tiller factory.

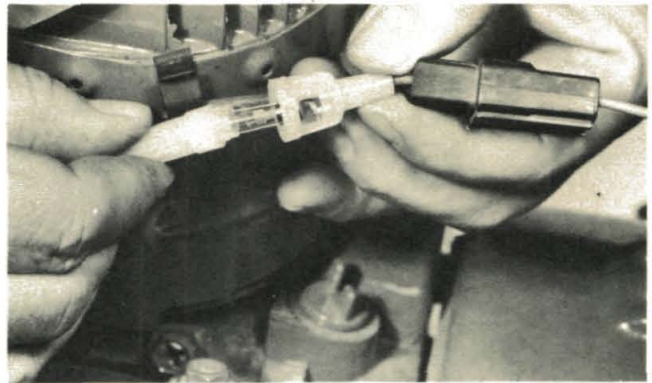

(Photo 7/58) Remove fuse and tape.

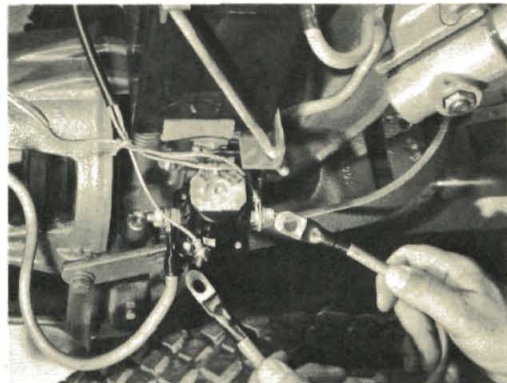

(Photo 7/59) Touch jumper to right post.

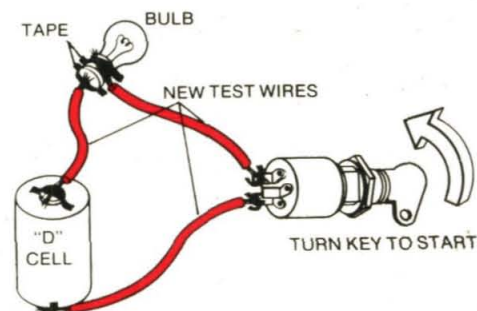

(Sketch 7/60) Test key switch with light.

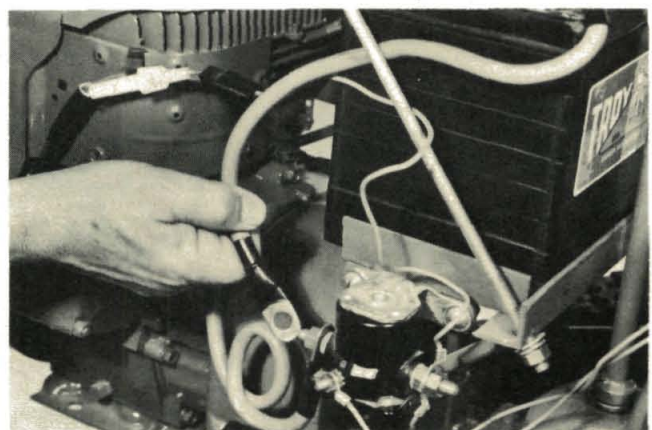

(Photo 7/61) Testing solenoid.

You will see that there is a fuse on the battery recharging line coming from the engine, as shown in Photo 7/58. Remove the fuse and look at it carefully. (Push the two halves of the fuse holder together and turn the top half counterclockwise to separate the two halves.) If the fuse is okay, then there is a fair chance that it is either your diode not recharging your battery (causing your battery to be run down), or that the fault is with the electric start motor on your engine. If you feel it is the electric start motor on your engine, it would be best for you to have an authorized Tecumseh service dealer look at your engine to solve the problem.

If your electric start motor turns over but does not start the engine, it may be that you should be looking toward other engine functions for the answer to your problem. Check for problems with the fuel, ignition or carburetor.

ENGINE STOP SWITCH (6 HP TECUMSEH)

If you cannot start your engine for any apparent reason, one thing to do is to check the action of the engine shutoff switch (shortout clip) underneath the speed control assembly bracket by the carburetor. As shown in Photo 4/14 in Section 4 (on engines), the shutoff switch is a bent tab underneath the bracket to which is attached a wire leading into the engine's magneto. If the spring clip is bent so that it touches the bracket at all times, it will be doing the same thing as stopping the engine; and therefore, preventing you from starting the engine.

A simple way to check this is to disconnect the terminal at the clip and put some electrical tape on the wire's end to make sure it touches no metal at all—see Photo 7/62B. And then, try to start your engine. If your engine starts right up, you know that the tab was grounding the engine out and preventing it from starting. All you have to do is bend the tab out a little way and then make sure that the remote control lever completes the connection and stops the engine as it should. See Photo 7/63.

A short somewhere else in this wire would be more serious and would have to be taken care of by a service dealer. This, however, is a very rare occurrence.

IGNITION SYSTEM

If your engine won't start, the most common causes are ignition, electrical (for battery start engines), fuel or carburetion problems. Many of these causes can be corrected easily and quickly, once they are determined.

If your carburetor is adjusted correctly, and you have enough compression to run the engine, and your fuel is fresh, clean and without any water in it, then not being able to start might well be the fault of your ignition system.

The first thing to investigate in checking ignition problems is your spark plug and its wire. Make sure that the connection to the wire is secure and there are no breaks or bare spots on the wire.

Then, remove the spark plug and look at it. If the plug is dirty, encrusted with deposits and corroded, you'd best replace it. Look at the gap to be sure that it is within tolerance. See the specifications table for your engine (at the end of Section 9) for the spark plug gap. If there is wet oil on the plug, look for the source of the oil problem (which is most likely your *real* problem). Is your oil too full, are the rings worn on the piston, is the crankcase breather clogged?

If you have a good or a new spark plug (removed from the engine), attach the lead wire to it and lay the plug down on any metal part of the engine. Then, pull the starter rope with a firm pull and observe the gap in the spark plug while you do it. If you see a strong, bright spark, your ignition system seems to be in working order, so look in other directions for your failure to start the engine. If you don't get a spark or get a very weak spark with a good or new plug touching metal, you can expect a problem with the ignition system itself or with the engine shutoff switch and wire.

The engine shutoff switch can be easily checked by prying the terminal wire off the shutoff switch and taping the metal with electrical tape as shown in Photo 8/62A and B. The tape won't allow the switch wire to touch metal. Then, if you pull the starter rope and the engine starts, you know that the shutoff was touching the carburetor mounting bracket and preventing engine startup. Simply bend the switch away from the bracket slightly so that it doesn't touch anything except the prong on the throttle lever when engaged—see Photo 7/63.

Incidentally, to shut off an engine that is running while you have the short out wire taped up, either remove the tape and touch the wire to any part of the engine's metal—away from the rotating flywheel for safety—or simple move the lever on the carburetor to the full choke position. **Only stop the engine with the choke in emergencies, since repeated use of it can be harmful to your engine.**

If your engine does not start with the shutoff wire detached, you'll most likely need an authorized engine service dealer to help you since you'll need the coil checked, the condenser and points checked, and possibly, the flywheel checked. Don't attempt to make these checks yourself unless you have experience and training in doing so.

If you have a battery electric starting tiller, refer to page 16 and those that follow for the possible answer to your problem.

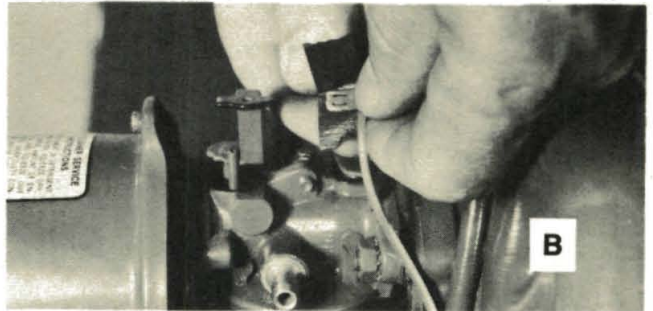
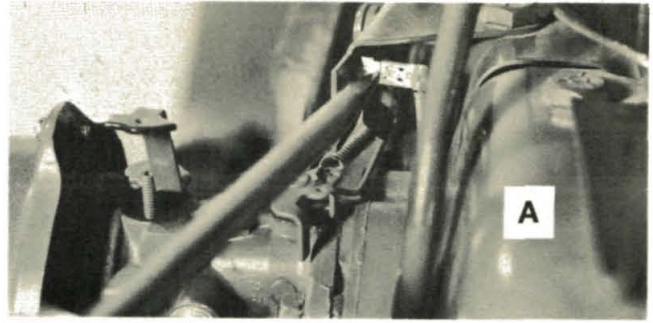

(Photo 7/62A and B) A. Use screwdriver to pry wire terminal off switch. B. Tape metal terminal for test.

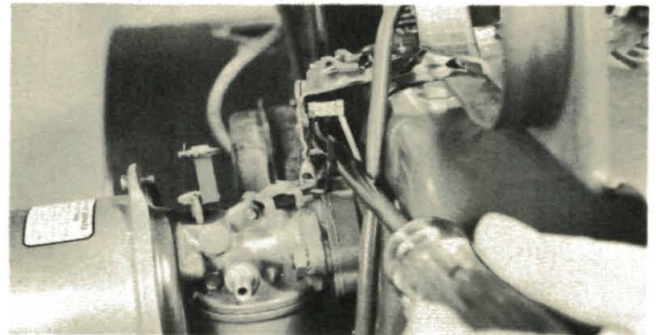

(Photo 7/63) Bend shutoff switch away from bracket a little way.

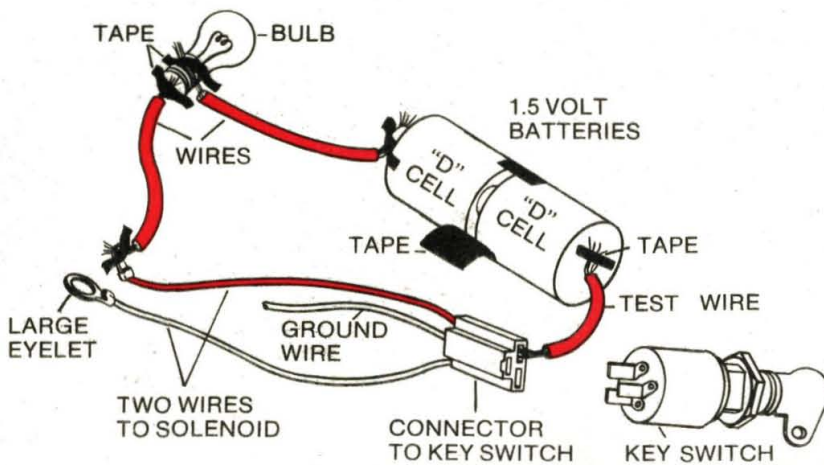

(Sketch 7/64) Use 1 or 2 flashlight cells, 3 wires and tape to test wires.

Testing Key Switch Wires

To test the wires leading to the key switch if your electric starter fails to turn over as described on page 118 (jumping the key switch wires), use some tape, two pieces of wire, two "D" cell flashlight batteries and a flashlight bulb to test each wire. If the bulb lights up, the wire is good.

TILLER SERVICE SCHEDULE

Transmission Service

1. On a new tiller or transmission, check the transmission oil level after 2 hours of operation, then every 10 hours thereafter.
2. Check for oil leaks at oil seals, gaskets, front and rear bearing caps, tiller housing cover, transmission cover, pipe plugs and "O" rings after the first 2 hours of operation, then every 20 hours thereafter. (Refer to page 10 of the **Master Parts Catalog** for locations.)
3. Check the tightness of the tiller covers and the front and rear cap mounting bolts every 20 hours of operation. (Remove the left tine holder to check the tightness of the tiller housing cover mounting bolts.)

Belts and Disc

1. Check "V" belts for wear and proper tension every 20 hours of operation. Replace them after three seasons of tiller use, or whenever they are overstretched.
2. Check the reverse disc for wear and alignment with the lower pulley every 20 hours of operation, or whenever it is exceptionally noisy.

General Tiller Service

1. Oil and grease the new tiller after the first 2 hours of operation, then every 10 hours. (See Photo 7/1 at the beginning of Section 7 for a lubrication chart.)
2. Check bolts, nuts and screws throughout the tiller for tightness after the first 2 hours of operation, then every 10 hours thereafter.
3. Check the tires for equal pressure occasionally.
4. Check the tines for wear every 30 hours.
5. Check the freedom of controls prior to each use.

ENGINE SERVICE SCHEDULE

Oil Service

1. Check the engine oil level prior to each day's operation and at least every 2 hours during continuous use.
2. Change the oil after the first 2 hours during the initial break-in period and every 10 hours thereafter. Change it more frequently in dusty, dry conditions.

Air Cleaner Service

1. Sponge Element Type (Tecumseh): Check it daily, or every 2 hours during continuous operation. Clean the element every 10 hours, or more often in dusty, dry conditions.
2. Dry Element Type (Kohler): Check it daily, or every 2 hours during continuous operation. Vacuum clean the element every 10 hours of operation, and replace it every 50 hours or whenever it can't be cleaned, or when torn.

Cooling Fin Service

1. Check and clean dirt and debris from the cooling fins prior to each daily operation and every 10 hours of engine operation.

Ignition Service

1. Check the spark plug for carbon deposits or wetness (caused by oil) and for the electrode gap every 25 hours. Replace the spark plug every 100 hours, or at least once during a season.
2. Ask for our tune up instructions to check or change the breaker points every 100 hours. Bad points will be burnt, pitted, oxidized, dirty or oily.

General Engine Service

1. Check screws, nuts and bolts (particularly the head and crankcase bolts) for tightness every 40 hours. (See the bolt torque in engine specifications, page 175 and 176.)
2. Check the carburetor linkage for freedom of movement every 10 hours.
3. Check the engine gaskets (head, oil pan, breather and dipstick) for leaks every 20 hours.

4. Check the hole in the gas cap after each use of the engine to make sure that it is unobstructed.
5. Check the starter rope occasionally to make sure that it is secure and in good condition.

NOTE: For further details, see the engine manufacturer's owner's manual.

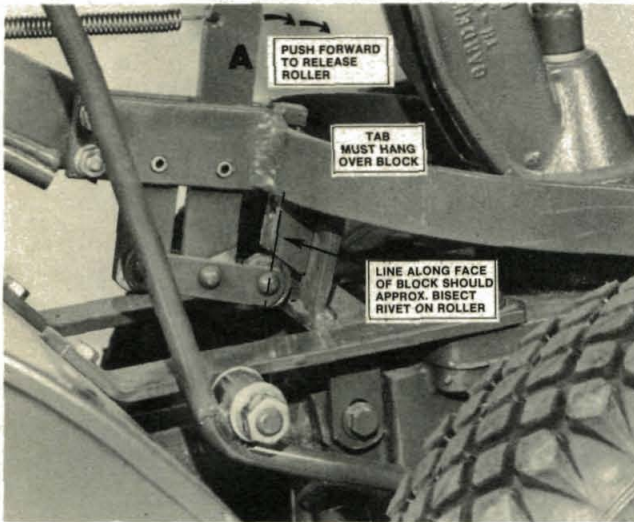

(Photo 7/65) If the tiller locks in Forward, push Lever **A** forward to release the roller. Inspect the roller. It might have a flat spot.

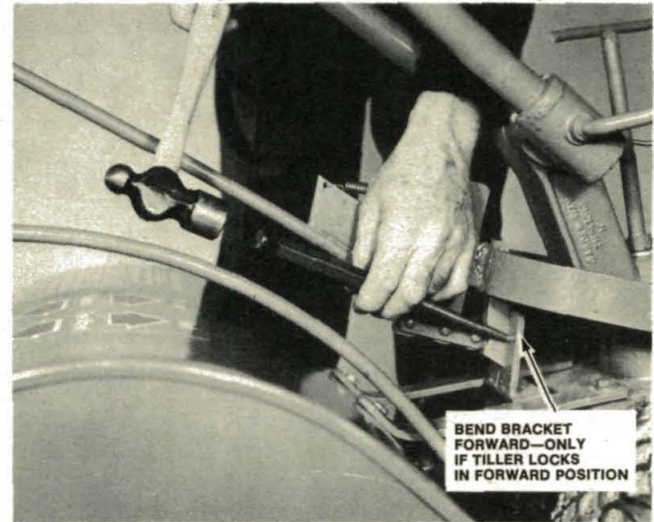

(Photo 7/66) Grease the block and roller. Bend the bracket forward **only** if the roller goes more than half-way under the block.

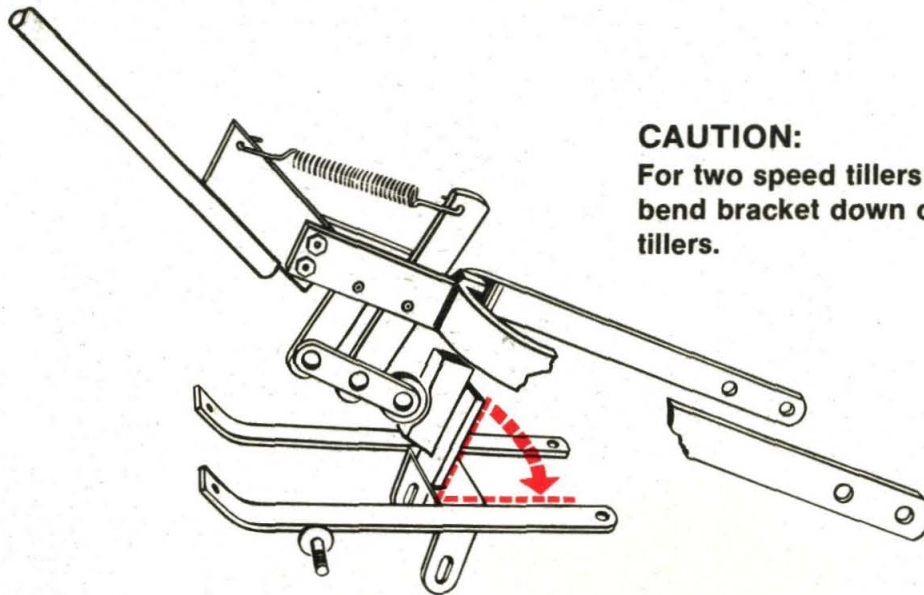

(Sketch 7/67) Reduce angle shown by bending block down a very small distance.

CAUTION:
For two speed tillers only. Do not bend bracket down on four speed tillers.

HOW TO REPLACE COMMON PARTS

REMOVING AND REPLACING WHEELS

In order to perform numerous service tasks on your Troy-Bilt Tiller, you will need something strong enough to put under the transmission to hold the wheels up off the ground an inch or two. We have found that making a block out of three short lengths of 2" x 4" pieces of wood is a very handy thing for such maintenance. See Photo 8/1 for the block in use.

Nail a 7", an 11½", and a 13" piece together, like steps, so that the ends are flush with each other. In this way, you can prop up different parts of the tiller, using the same blocks.

REMOVING 4:00x8 SINGLE-PIECE STEEL WHEEL

To remove your single-piece steel wheel from your tiller, all you need to do is prop up the transmission of your tiller and drive the roll pin down through the wheel hub to free the wheel—see Photo 8/2. To do this, you can use a ¼" diameter steel rod, a 16d nail with the pointed end blunted, or a 3/16" tapered, or ¼" untapered drift pin. Then you merely squirt some penetrating oil on the wheel shaft and pull the wheel off to change it, or do whatever maintenance is required. You can then put the wheel back on and tap in the same roll pin to hold it securely. Use an Allen wrench or screwdriver to help you align the holes while you drive in the wheel pin—see Photo 8/3.



(Photo 8/1) One method of holding wheels up.

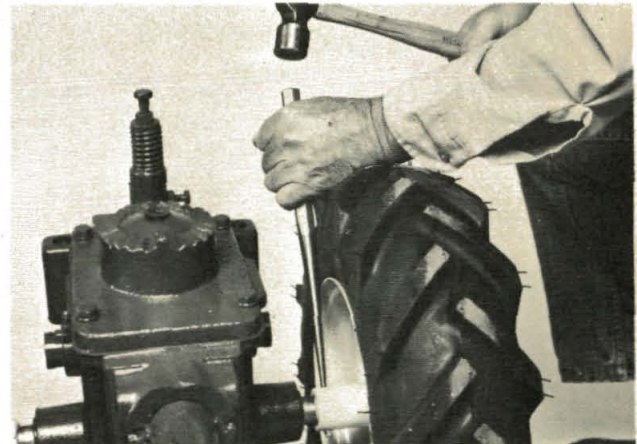

(Photo 8/2) Drive out roll pin.



(Photo 8/3) Align holes with hex wrench.

HOW TO REMOVE AND REPLACE A WHEEL SHAFT OIL SEAL

It's easy to replace a wheel shaft oil seal. All you need to do is follow these simple step-by-step instructions.

Before you remove the seal, check the wheel shaft by trying to "wiggle" it up and down, and then from side to side. If the shaft moves more than 1/4" when you do this, please call your Customer Service Representative at the Tiller Factory!

Step 1—Prop up your tiller and remove the wheel as shown in Photos 8/1 and 8/2. Squirt some penetrating oil on the wheel shaft before removal.

Step 2—Place a pan below the seal to catch any oil drips. Next, drive the tip of a screwdriver into the seal at a slight angle, as shown in Photo 8/4. After puncturing the seal on one side of the axle, drive another hole in the side opposite the first hole. Take care not to drive into the wheel axle itself.

Step 3—Tap down on one screwdriver and force the seal to rotate as shown in Sketch 8/5. This will break any grip the gasket sealant has formed between the seal and the transmission bore.

HELPFUL TOOLS YOU'LL NEED

- 2 medium screwdrivers
- Hammer
- 3/8" wrench or adjustable wrench
- A 16-penny (16d) nail with the end blunted, OR a 3/16" tapered or 1/4" untapered drift pin, OR a 1/4" diameter steel rod
- Penetrating oil
- Fine metal file or 400 grit paper or cloth
- A 4 1/2" x 4 1/2" sheet of thin, flexible plastic similar to photo album page protector sheet
- Axle grease or lubricant
- Pieces of board to block up tiller
- A 6" length of 1" (inner diameter) Standard black pipe. Available at hardware or plumbing stores.
- Part No. 9601 wheel shaft oil seal*
- Non-hardening gasket sealant**
- Large, flat 1" washer***
- Shallow pan to catch oil drips

*Available separately, or in special Seal & Gasket Parts Kit No. 1309

**If not available locally, order special Seal & Gasket Parts Kit (Part No. 1309)

***If not available locally, order special Washer Parts Kit (Part No. 1344)

8

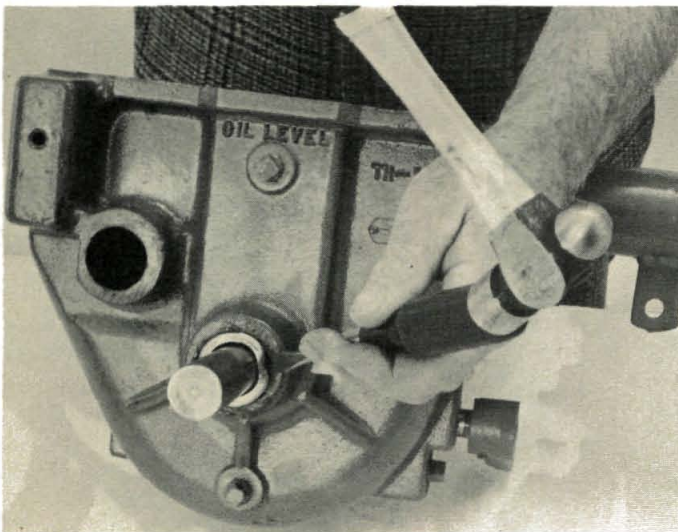

(Photo 8/4) Drive tip into both sides of seal.

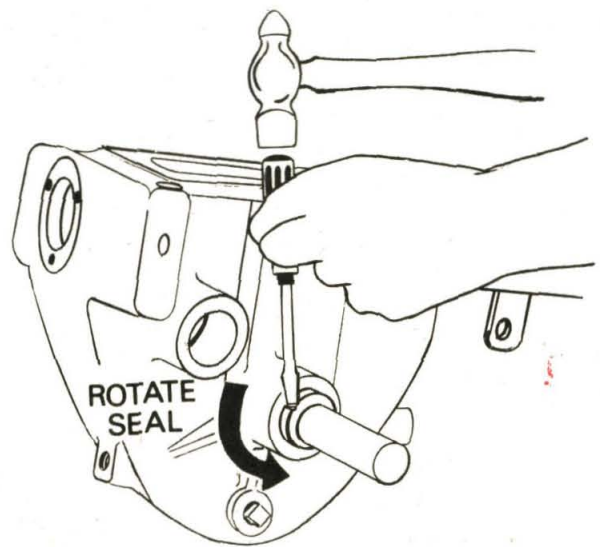

(Photo 8/5) Rotate seal in bore to loosen it.

Step 4—With both screwdrivers firmly embedded (Photo 8/6) pry the seal outward by pressing the blades against the transmission case.

CAUTION: Be careful not to scratch or gouge the shaft or the inside of the bore as you remove the seal.

Step 5—With the seal removed, carefully clean the surfaces of the wheel shaft and the transmission bore. Then, using a fine file or 400 grit paper or cloth, smooth off any burrs or sharp edges on the end of the shaft or around the hole for the roll pin. Clean off any metal particles.

Now, replace the same number of shims (they look like thin, flat washers) that were on the shaft, or add one if none were present. The shim protects the oil seal from scraping against the snap ring inside the bore.

Before discarding the old seal, check that one of the shims is not still stuck to the back of it.

Step 6—Use the thin, flexible plastic to protect the seal from cuts when you slide it over the shaft. If you can't find the plastic, use a sheet of letter paper stationery or at least cover the end of the shaft and the roll pin hole with transparent tape.

As shown in Photo 8/7, roll the plastic or paper into a tube and insert it halfway through the seal. Slide the tube and seal over the shaft and up to the bore opening.

IMPORTANT: The side of the seal having writing on it must be facing outward on the wheel shaft.

Step 7—Coat the outer edge of the seal with *non-hardening* gasket sealant, as shown in Photo 8/8. The sealant (such as Permatex or Plasgon) helps to prevent oil leaks between the seal and the bore. After coating the seal, remove the plastic from the wheel shaft.

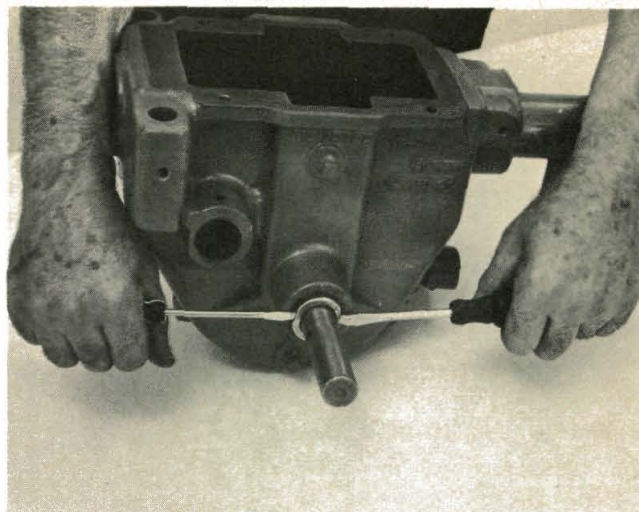

(Photo 8/6) Pry oil seal out.

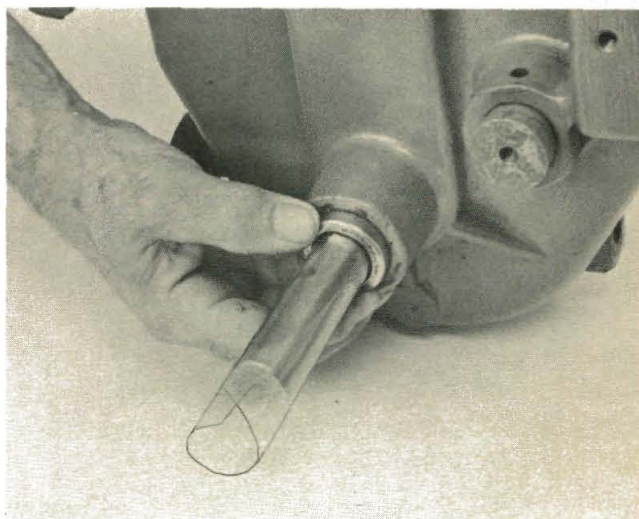

(Photo 8/7) Name and number on seal face out.

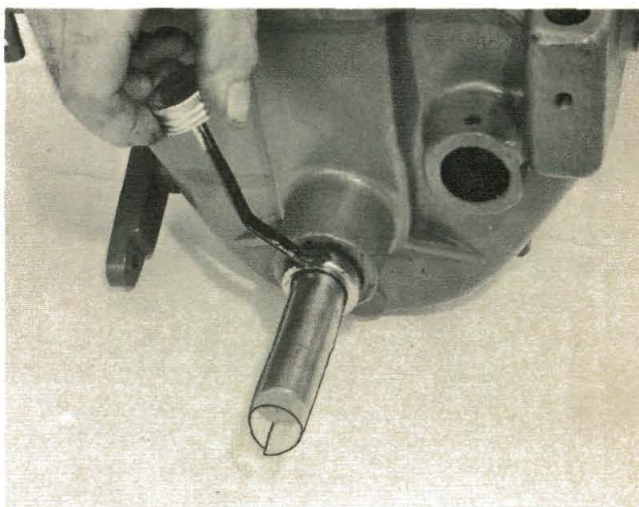

(Photo 8/8) Apply sealant to outer edge of seal

Step 8—The best way to seat the seal in the transmission bore is to use a thick, flat 1" washer (with a 1-1/16" diameter), and a 6" length of 1" (inner diameter) Standard Black pipe, as shown in Photo 8/9.

When you tap the pipe with a hammer, the washer will apply equal force around the face of the seal. This will prevent it from going into the bore at an angle or caving in at the center. Now, gently tap the seal in until it is *almost* flush with the transmission bore. The little edge you leave protruding will make it easier to remove the seal at a later date, if necessary.

Please be sure that the seal enters the bore straight and without bending. If it goes in crooked, it will most likely tear and leak badly.

SPECIAL NOTE: In an emergency, and if you're careful, you can also use the tiller wheel to seat the seal—see Photo 8/10. Just slide the hub of the wheel up against the oil seal, and gently tap the seal into place—a handy trick that a Troy-Bilt Owner showed us!

Apply some grease or oil to the shaft and replace the wheel. Tap in the roll pin until it is flush with the wheel hub.

Check the level of the transmission gear oil. Replace gear oil if the level is below the oil level plug, which is three inches above the wheel shaft on the left side. Use SAE #140 or SAE #90 gear oil if available. You may use a multiviscosity #85-140 gear oil if the other gear oils are unattainable.

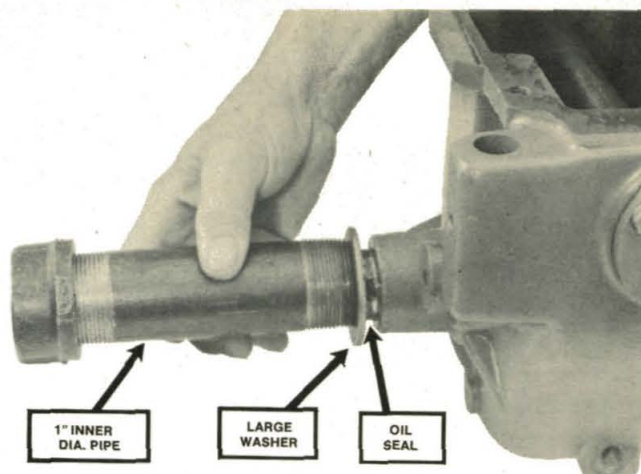

(Photo 8/9) Use 1" washer between pipe and oil seal

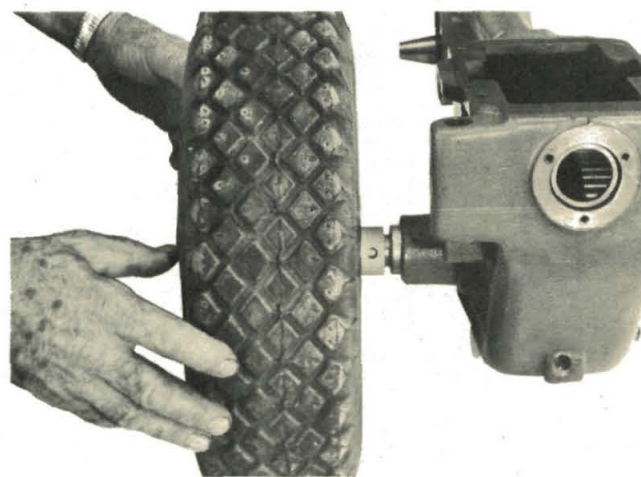

(Photo 8/10) Use wheel to seat oil seal.

PLEASE NOTE: A properly installed oil seal should give you long and trouble-free service. Please don't be overly concerned if a newly installed seal leaks. It may take several hours of tiller operation for the seal to become completely effective.

TILLER SHAFT OIL LEAKS

Oil might leak from the area of the tiller housing because of a damaged oil seal, a loose tiller housing cover, loose cover mounting screws, or screws which had no sealant put on their threads. To replace the tiller shaft oil seals, you

will have to remove the tines from your tiller. First remove the tiller hood, as described on page 136 in this section, then see the instructions on tine removal on page 141 in this section of the manual.

REPLACING THE TILLER SHAFT OIL SEALS

HOW TO CHECK AN OIL LEAK

First of all, if you suspect that you have an oil leak at the tiller shaft, you should determine exactly where it is coming from. It might be that it is leaking through the shaft seal. Otherwise, the oil may be leaking through the gasket (part #1129) and around the tiller housing cover (Part #1023) on the left hand side of the tiller shaft. (Please see page 10 of your Master Parts Catalog for the location of these parts.) Please be sure that you had #90 or #140 gear oil in the tiller transmission. A lighter oil, such as motor oil, will leak badly.

If you suspect that the oil seal is leaking, wipe all the oil off the parts and run the tiller for a short while (without tines installed). Then, look and feel with your fingers to determine which area has oil on it.

To save yourself unnecessary work, make sure that the oil is leaking through the oil seal—that is, between the tiller shaft and the oil seal—before you go to the trouble of changing it. A leak between the gasket and the tiller housing cover can often be misinterpreted as a leaking oil seal.

REMOVING THE LEFT-HAND TILLER SHAFT OIL SEAL

If you are sure the tiller shaft seal on the **left-hand side** is leaking, the easiest way to replace it is to first remove the tiller housing cover (part #1023). The seal will remain in the cover and can be removed and replaced more easily. (Instructions for removing the **right-hand** seal are given further on in this section.)

To remove the tiller housing cover, first remove the five socket head mounting screws with a 3/16" wrench—see Photo 8/11. Before you remove them, note whether any of the screws are loose, particularly the two on the top. It might be an indication that the oil is leaking past the cover. When the screws are removed, try to remove the cover with your fingers. Note how snugly it fits and whether or not there is any movement from side to side. If you have to tap the cover off lightly with a hammer, or find it difficult to pry it off with your fingers, the cover probably fits properly. It should be snug.

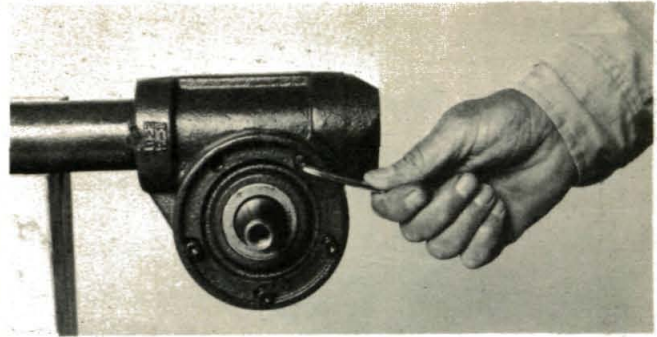

(Photo 8/11) Remove tiller housing cover screws.

Once the cover is off, you will see that the cup for the tiller bearing and the oil seal remain intact in the cover. To replace the oil seal, you should carefully tap the seal out of the cover from the inside outward. The easiest method is to use a 6-inch length of 1½" (inner diameter) pipe to drive the seal out of the cover.

Do this by placing the cover upside down between the two blocks of wood. There is nothing to prevent the seal from coming out the other side—see Photo 8/12. Tap it gently out from the inside, being very careful not to score the internal side of the cover, or the bearing cup.

It is possible to remove the seal in this manner from one cover and reinstall the same seal in another cover without doing any damage to the seal. But, it is best to use a new seal each time. Don't reinstall the seal in the cover until after you have removed the seal in the *right side* of the tiller housing, if that is to be replaced as well. You will use the cover to center your tiller shaft if you are going to replace the right oil seal.

REMOVING THE RIGHT-HAND TILLER SHAFT OIL SEAL

Removing a seal from the right side of the tiller housing will require you to remove the tiller shaft and gear cluster. *It is much harder to try to pry the tiller shaft seal out of the right side than it is with a wheel seal.* Once the cover on the left side has been removed, simply tap the right side of the shaft inward hard enough to drive the shaft, bronze gear and bearings toward the large hole on the left (that had been occupied by the cover). Lift up the shaft on the left side to align the bronze gear with the hole as you hit the shaft—see Photo 8/13.

Don't worry about the bronze gear; it won't be damaged. Once the bronze gear is free from the steel worm, lift the gear assembly out and put it safely aside. (If you do have difficulty removing this gear, see the note on page 129.)



(Photo 8/12) Carefully tap seal out of cover.



(Photo 8/14) Drive oil seal outward.

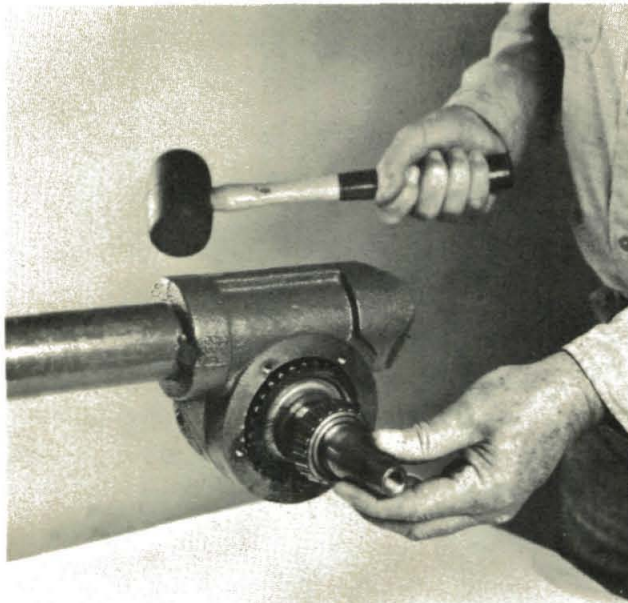

(Photo 8/13) Lift and align gear with opening.



(Photo 8/15) Check key that drives bronze gear.

When you reinstall the shaft and gear cluster, it doesn't matter which side you put in the tiller first. But, you may want to reverse the direction of wear (to even it out) by putting the opposite side in first. Mark one side, if you wish to do this.

Now, drive the tiller housing oil seal (on the right side) outward, by placing the 1½" pipe carefully inside the housing against the seal—see Photo 8/14. Make sure that you don't unseat the bearing cup on that side. Tap the seal out.

When the seal is out, inspect the opening on the right side of the tiller housing and the bearing race (cup) for any sign of damage.

Inspect the keyways for the tine holder keys in the tiller shaft and gear cluster. If there are any sharp edges, file them down, or use emery cloth. Make sure there will be no sharp edges to cut the new seal.

Look carefully at the bronze gear and the key in the keyway. If the key is exposed more on one side of the bronze gear than the other (see

Photo 8/15), put the cover on a surface that will allow you to put the tiller shaft in the cover and pound it with a mallet—see Photo 8/16. Just put the bearing cone and the shaft in the cup (mounted in the cover, part #1023, with no seal installed). Make sure that the shaft has enough clearance to be driven down. Then, hit the shaft down until it stops moving. Turn the shaft over and repeat the process. This will cause the bronze tiller worm gear to align itself in the center of the tiller shaft. The key should not protrude out of the keyway any further on one side than it does on the other—see Photo 8/17.

When this is done (if it is even necessary, because most times the tiller shaft will come out of the housing without disturbing the position of the worm gear), replace the tiller shaft inside the tiller housing, as shown in Photo 8/18.

Please Note: If you have difficulty and find that you **cannot** drive the bronze tiller gear cluster out the left side of the tiller housing, the steel worm on the main drive shaft is probably blocking your way. Simply pull up on the left side of the tiller shaft, while you simultaneously press down (hard) on the right side. This action should deform the oil seal on the right side and provide the added clearance you need to extract the tiller gear cluster.

HOW TO REPLACE TILLER HOUSING SEALS

Before replacing the right or left tiller shaft seals, carefully inspect the keyways in the tiller shaft (part #1026) to make sure that there are no sharp edges. Here too, file lightly to avoid cutting the new seal being installed. Apply a non-hardening Permatex, Loc-tite, or Plasgon gasket sealer to the outer metal surface of the new tiller shaft seal before you install it.

A mechanic's thin walled metal sleeve is the best way to protect the seal from being cut and to seat it properly. If you have no metal sleeve, you can cover the keyway with transparent tape. You should install a right tiller shaft seal extremely carefully, by tilting the seal on the bottom side of the shaft as you pass it above the keyway on the top of the shaft, then pivoting the seal up over the keyway, as shown in Photo 8/19. This will keep the seal away from the keyway during the process. Then, put gas-

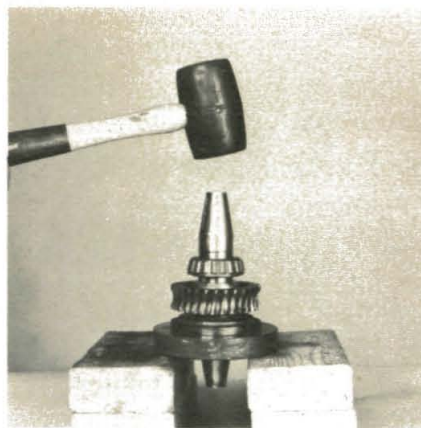

(Photo 8/16) Hit with mallet.



(Photo 8/17) Key properly in place.



(Photo 8/18) Replace tiller shaft.

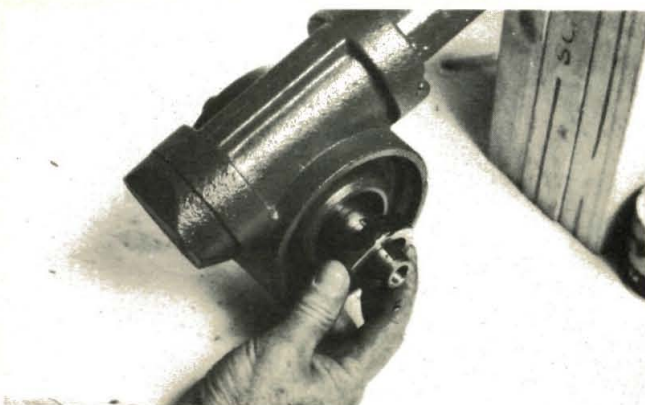

(Photo 8/19) Keep seal away from keyway.

ket compound on the outer metal of the seal and drive it into the bore of the tiller housing. Be very careful to never allow the rubber to touch the tiller shaft around the keyway, since the slightest sharp edge could cut it and cause it to leak.

You can gently tap the right seal on the tiller shaft into the housing bore with a small piece of 1½" pipe. If the pipe is threaded on one end, so much the better. Just put a cap on it and it will give you a surface to tap on more firmly and squarely—see Photo 8/20. Otherwise, tapping the seal into place with two hammers—one on each side of the seal—is a method that works out quite well. As you tap with a 1½" pipe, work the pipe to the outside edges of the seal. Alternate from one outside edge to another. This will prevent the pipe from centering on the seal and caving it inward.

REPLACING AN OIL SEAL IN TILLER HOUSING COVER

PLEASE NOTE: If you are checking the tiller housing cover (part #1023) for a proper, snug

fit, you should make your check while the bearing cup (part #9402) is installed in the cover, but *before the seal has been installed*. This way, you can determine how well the cover fits.

To replace the seal on the left side, you merely turn the tiller housing cover back over (with its outside facing up) on the blocks of wood and use the 1½" pipe cap, or another block of wood, to tap the seal in place, gently and evenly. Or, if you wish, you can tap the seal on the shaft with the 1½" pipe after the cover has been fastened in place—see Photo 8/21. (Please read further for instructions on replacing the tiller housing cover.) Remember to put a gasket sealer (like Permatex) around the outside of the seal before installing on either side of the transmission. Drive the seal in until it is nearly flush with the casting. **Don't center the 1½" pipe as you drive the seal in. Keep moving it from one outside edge of the seal to another.** This is to prevent the seal from caving in at the center and peeling the seal's metal back as you drive it in the housing. To reinstall your tiller cover, see the following instructions on tiller cover installation:

8

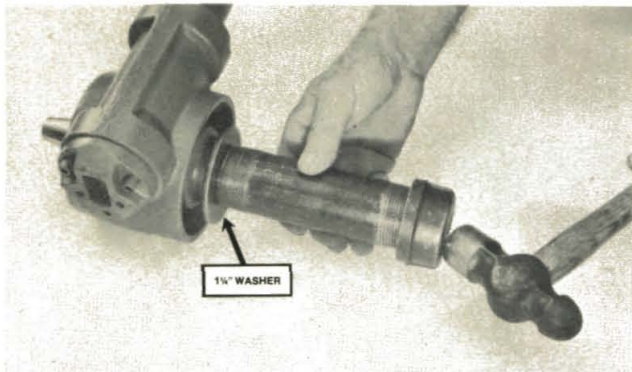

(Photo 8/20) Use 1¼" washer between pipe and seal.



(Photo 8/22) Turn shaft forward and backward.



(Photo 8/21) Replacing seal with cover on.

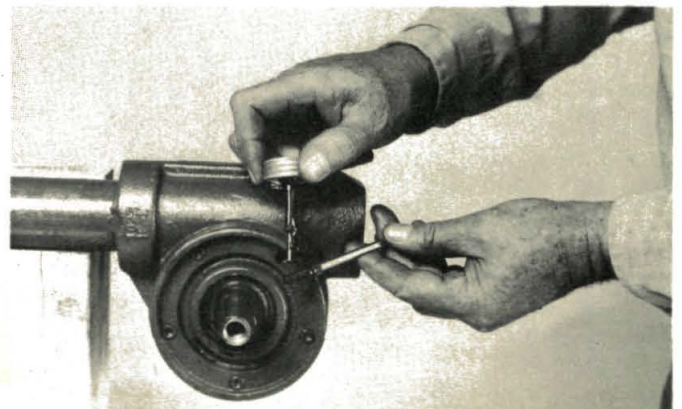

(Photo 8/23) Apply sealant to screw threads.

BrentChalmers.com

HOW TO REPLACE A TILLER HOUSING COVER (PART #1023)

Remove the tines and tine holders if they have not already been removed—see page 141. Then, remove the five socket head screws (Allen screws) from the tiller housing cover on the left side of the tiller—see Photo 8/11 in an earlier portion of this section.

Try to pry off the cover with your fingers; note how difficult it is to remove.

Place a thick gasket (part #1129-2) on the cover and put the cover in the tiller housing. **Put two socket head screws in and tighten them up firmly in holes opposite each other on the cover.** With these screws down tight, you should be able to tell whether the cover is a good fit. There should not be a great amount of side-play in the tiller shaft from left to right. But, the cover should not be so tight that there is absolutely no give at all, or it will bind up on the bearings.

If you push or pull on the tiller shaft and can feel virtually no movement, then grab the tiller shaft in your left hand and on the other side in your right hand—see Photo 8/22. Try to turn the tiller shaft forward or backward and see if you can feel a little bit of backlash (a tiny bit of movement that stops suddenly) in your right hand. If these two conditions are met, the tiller cover is a good fit.

Lack of any side-play of the tiller shaft or backlash (explained above) indicates the cover is in too close to the tiller housing. Remove the cover and add to the gasket thickness—.040 inch total thickness should relieve the pressure on the bearings. **Too much shaft side-play** calls for less gasket thickness under the cover. Then, .020 inch total gasket might do it.

When you've determined the proper gasket combination, put Permatex **on the threads** of the remaining three socket head screws and tighten them down snugly to hold the cover in place. Then, remove the first two socket head screws, put Permatex compound on them and replace them—see Photo 8/23.

After carefully sliding it over the keyway, put Permatex on the outer edges of a seal (part #9602) and drive it in place with a 1½" pipe, as shown in Photo 8/21. You can also put the oil seal in the cover before you install the cover, but be careful not to cut the seal on any sharp edges of the keyway. A flat block of wood will drive the seal into the cover lying on a bench quite nicely. (See the preceding instructions for replacing a seal in the cover.)

HOW TO REPLACE THE FRONT OIL SEAL ON THE TILLER TRANSMISSION

If you suspect that you have transmission oil leaking from the front end of your tiller, check it out before you go through a lot of trouble and work. It could be that there is an **engine oil** leak at the power take-off (PTO) shaft of the engine. However, if that is the case, it also might flow down between the engine and the engine mount (part #1002).

If you suspect a leak in the front end of your transmission, the best way to be sure is to look through the cut-out on the left-hand side of the engine mount. There is a ledge on the bottom of the engine mount and oil will collect there. *Of course, the oil could still be coming from the PTO shaft of the engine, but this will be evident when you remove the engine.*

Also, if you have too much oil in the transmission of your tiller, it can fool you into thinking that there is a front end oil seal leak. Check to make sure the oil is not coming out of the hole for the reverse spring and plunger (on top of the transmission) and running down the front when you tilt the tiller up. Feel around the hole where the spring is located for oil. If this is the case, don't worry about the seal. Check your tiller transmission oil level. Be sure it is no higher than the oil level plug 3 inches above the left wheel axle.

Another possibility is that transmission oil may be leaking through the gasket between the transmission cover and the transmission case when you tilt the tiller up. If you suspect this, put your finger around the front of the transmission cover and feel for excessive oil. If

it is wet with oil there, don't worry about the oil seal in the bearing cap. The tiller was designed to relieve a little excess oil pressure there in certain circumstances. (See "Oil Leaks" under "Trouble Shooting" in Section 9 of this manual.)

Before removing the front seal on the tiller transmission, you must remove the engine (see engine removal instructions, page 148, Section 8 of this manual) and the lower drive pulley (part #1008-1)—see Photo 8/24. You must also remove the two snap rings retaining the lower transmission pulley, the drive shaft key, and the three hex head bolts securing the front bearing cap (part #1114).

REMOVING THE PULLEY SNAP RINGS

To remove the snap rings (retaining rings) that limit the front-to-back movement of the transmission pulley, you will need a pair of small, **external** snap ring pliers—see Photo 8/25. They can be obtained from a good hardware or auto supply store. They also can be purchased from many lawn and garden equipment distributors.

It makes good sense to have an extra set of retaining rings (part #9500) on hand before you start. If you don't use snap ring pliers to remove them, you will spoil the ring's spring tension. Of course, **snap ring pliers will also be needed to replace the retaining rings in their proper grooves.** The front snap ring can be removed with two screw drivers, but you must be careful to avoid scratching the surface of the drive shaft.

To use two screw drivers to pry the **front snap ring** out of the groove on the shaft (see Photo 8/26), hold pressure on the ring with one screw driver while you "peel" the snap ring out of the groove with the other. Removing it this way will probably ruin the snap ring, so be sure you have another one available. There is substantial risk in removing the rear snap ring with two screw drivers. You could scratch the surface of the drive shaft. This scratch could cut your front seal when you install it. It could also give you problems in installing a worm, spacers and shims.

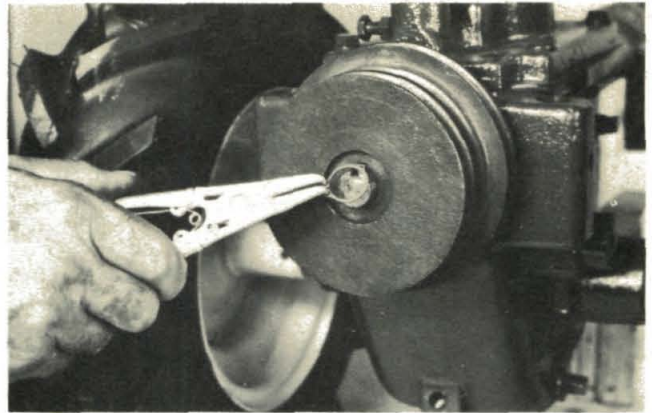

(Photo 8/24) Removing snap ring on lower pulley.

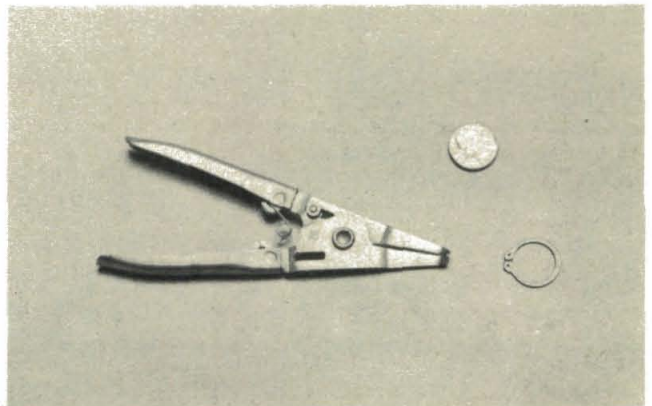

(Photo 8/25) External snap ring pliers.

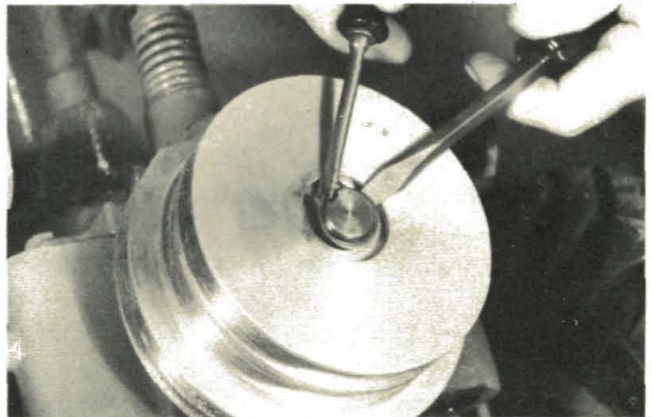

(Photo 8/26) Remove front snap ring.

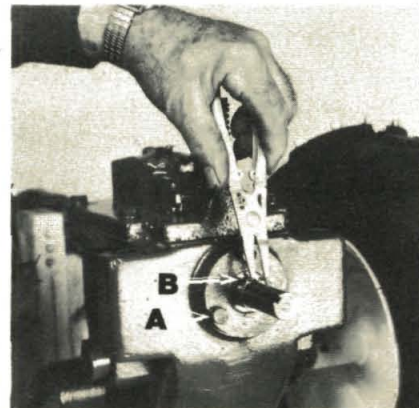

(Photo 8/27) Remove snap ring.

Whenever you change the front seal, it's a good idea to replace the front gasket (part #1124) as well. Once you have the front bearing cap off, you can pry the front oil seal out of it—see Photo 8/27. Remove the bearing cap by removing the three bolts, shown as **A** in the photo. The rubber seal is marked **B** in the photo.

Then, simply put on a new gasket (part #1124), replace the cap, and you are ready to reinstall the seal over the shaft. When you do, take great care and make sure the keyway for the transmission pulley and the grooves on the shaft for the snap rings don't have any sharp edges that will cut the seal. Either roll up a piece of letter paper stationery to cover the keyway, or wrap the keyway in transparent tape before pushing the seal over the shaft—see Photo 8/28. Then, install the seal evenly and flush all around the cap, with the closed end outward and the spring facing the transmission—see Photo 8/29.

ADJUSTING THE PLAY ON THE DRIVE SHAFT

When the engine has been removed, it is the perfect time to check for forward-backward play or movement of your drive shaft—see Photo 8/30. There should be practically no play, but it should not be so tight as to bind the bearings. This is also a good time to check the shaft around the pulley mounting location to make sure there is no rust. If there is, clean it off with a #400 grit paper or cloth and lubricate the shaft well.

If there is any play, shim the drive shaft from the rear.

SHIMS ARE LIKE THIN WASHERS

For those who are unfamiliar with the term "shim," a shim is a very thin piece of material, usually metal, that is used to fill the gap between two parts to get a snug, or proper, fit. In this instance, the shims look like very thin washers. If there is too much "play" in the drive shaft when you move it back and forth, you merely add the right combination of shims to leave just a trace of "play." Too much movement of the shaft will cause misalignment of the worms and the worm gears. Too little movement will cause the bearings to heat up. If the shaft is *too tight*, you take out shim thickness between the bearing cup and the end cap. If it's *too loose*, you add shim thickness.

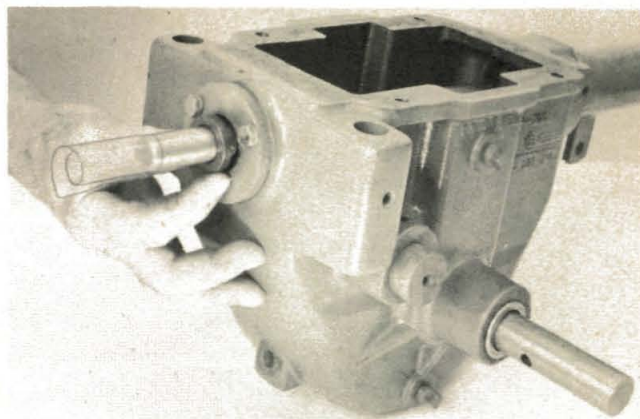

(Photo 8/28) Shaft wrapped with thin plastic.

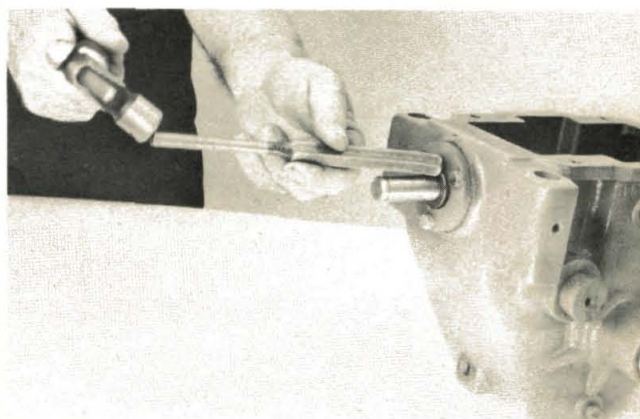

(Photo 8/29) Install seal evenly.



(Photo 8/30) Check for play in drive shaft.

IMPORTANT: It's best to test shaft movement at the front (with the lower pulley removed for gripping the shaft) because it's very difficult to detect drive shaft movement from the rear. As a test for looseness and during shimming operations, you can drain a few pints of gear oil out of the transmission, remove the handlebars and the top transmission cover to reach the drive shaft. Then, you can move the shaft (near the steel worm) back and forth to determine how much shimming is needed.

HOW TO IDENTIFY YOUR DRIVE SHAFT STYLE

Your tiller is equipped with either the single piece welded drive shaft shown in Photo 8/31, or with the assembled drive shaft shown in Photo 8/33. Both style drive shafts are equal in performance and dependability. You can easily identify which style you have by comparing your drive shaft with the photos.

View of welded drive shaft (Photo 8/31) with transmission cover removed and gear oil drained. If your drive shaft has a weld bead as shown, or if the worm measures 2" in length, you have a welded drive shaft. Photo 8/32 shows that the front worm (2 inches long) of the welded drive shaft is between the two welds. The shims and two bearing cones shown in the photo must be ordered separately when purchasing parts.

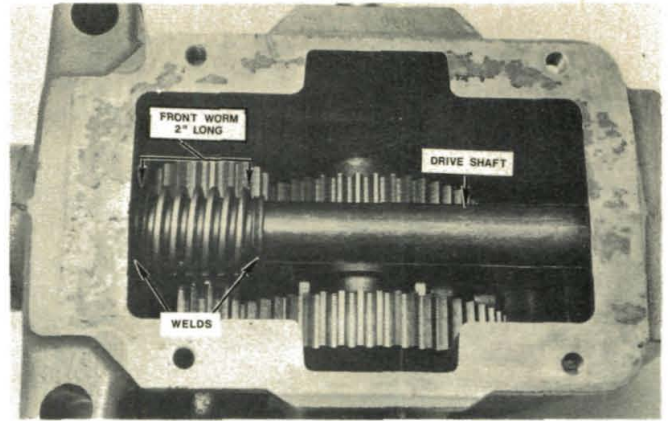

(Photo 8/31) Weld behind worm.



(Photo 8/32) Welded drive shaft.

(Photo 8/33) Assembled drive shaft with cover removed and gear oil drained. If there is no weld joint between the sleeve and worm as shown, or if the worm measures 1 3/8" in length, then you have an assembled drive shaft. Photo 8/34 below is an assembled drive shaft removed from the transmission case and disassembled.

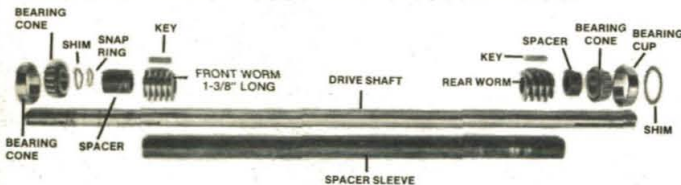

(Photo 8/34) Assembled drive shaft parts.

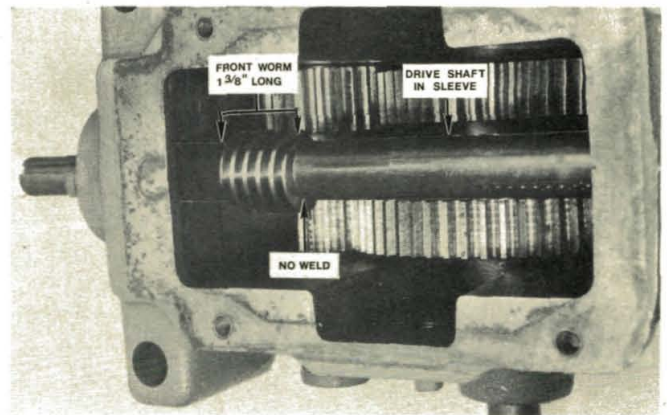

(Photo 8/33) No weld behind worm.

The following shims can be obtained from our Parts Department:

Part No.

1224-1 SHIM, 0.010" thickness (thin)

1224-2 SHIM, 0.030" thickness (thickest)

1224-3 SHIM, 0.005" thickness (thinnest)
used least.

One "10" is better than two "5's."

HERE'S HOW TO GO ABOUT SHIMMING FROM THE REAR

You must remove the tiller hood and disconnect the depth regulator from the rear cap. To do so, remove the two bolts on the front hood mounting bracket (part #1077)—see Photo 8/40. Then, remove the screws fastening the depth regulator to the end cap—see Photo 8/35.

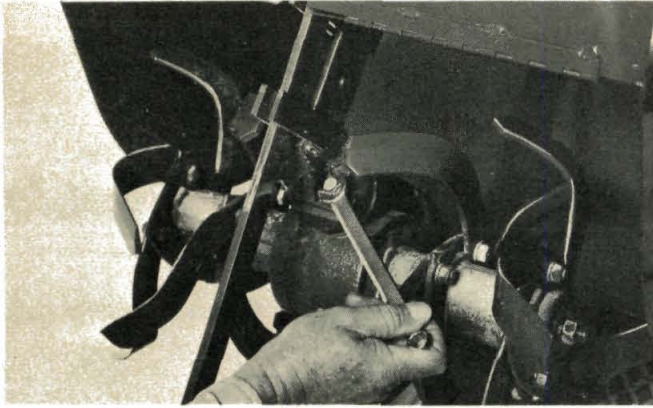

(Photo 8/35) Remove two bolts.

Take a 3/8" open end wrench and remove the three screws from the end cap—see Photo 8/36. Then, tap the cap off the end of the transmission gently with a small hammer if necessary. You should remove and replace the gasket (part #1124) on the rear bearing cap. To shim the play out of the shaft, use the part #1224-1, #1224-2, and #1224-3 shims—see Photo 8/37. These shims have the same inside diameter and come in thicknesses of 0.010", 0.030", and 0.005". You use various combinations of these shims as required to take the play out of the main drive shaft without putting undue pressure on the bearing.

Replace the end cap (see Photo 8/38) and hold it in position with your left hand while you hit the front of the drive shaft with a sharp blow from a rubber mallet—see Photo 8/39. Then try to move the drive shaft back and forth with your right hand.

When you have shimmed the bearing from the rear, and replaced the cap, pull the drive shaft back and forth from the front to determine if there is any play. Do this before you have put the lower transmission pulley (see page 136) on the shaft. *Remember*, although there should be almost no play in the shaft, it cannot be so tight as to cause binding on the bearing in the rear. This would heat up the bearing and eventually do much damage. On the other hand, if it is too loose, that is not good either. Being too loose will cause misalignment that will wear out the worm and worm gear. It might also loosen the rear cap during heavy tilling operations. Either case is potential damage to the tiller transmission.

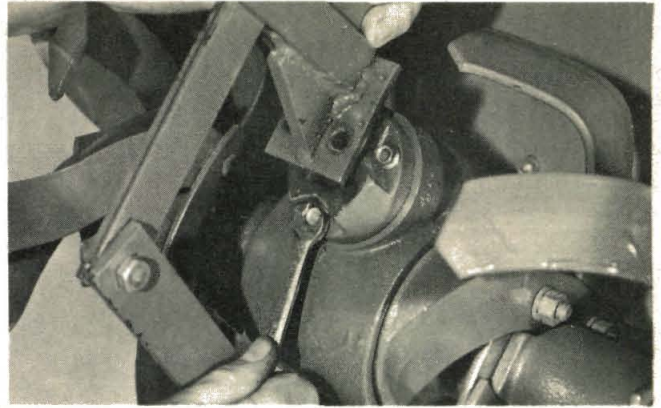

(Photo 8/36) Remove screws from cap.



(Photo 8/37) Shims remove play in shaft.

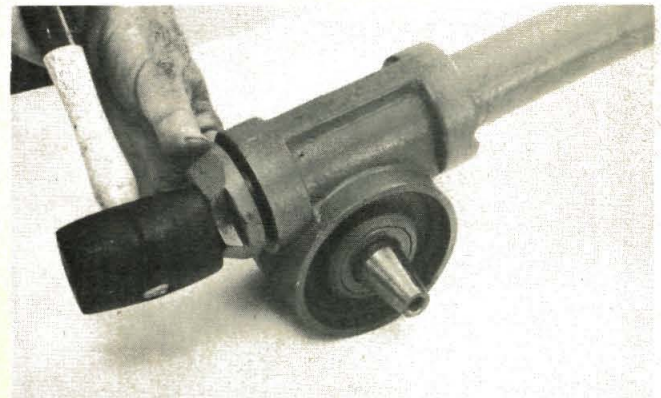

(Photo 8/38) Line up holes, tap on cap.



(Photo 8/39) Hold cap on, hit front of shaft.

REPLACE TRANSMISSION DRIVE PULLEY

Once the drive shaft has been shimmed, you can lubricate the front of the drive shaft and make sure any metal burrs are cleaned off of it. Then, put on the inside snap ring and the lower pulley (part #1008-1) and its key, followed by the outside snap ring. Make sure that the lower

pulley is able to float back and forth a fraction of an inch. Lubricating the shaft well will insure that the pulley is able to "float." Now, you are ready to reinstall the engine, in accordance with instructions given on page 148, Section 8 of this manual.

REMOVING THE TILLER HOOD

Step 1. Tilt your tiller up on its engine, taking care to place something underneath the engine cover to protect it from damage. Then, remove the two $\frac{3}{8}$ "-16 x 1 $\frac{1}{2}$ " bolts attaching the hood to the front hood bracket—see Photo 8/40.

Step 2. Remove the four small bolts and nuts that fasten the hood to the top of the rear bracket—see Photo 8/41.

Step 3. Take a small board and drive the knob off the handle of the depth regulator—see Photo 8/42.

Step 4. Lift the hood off the tiller, as shown in Photo 8/43.

8

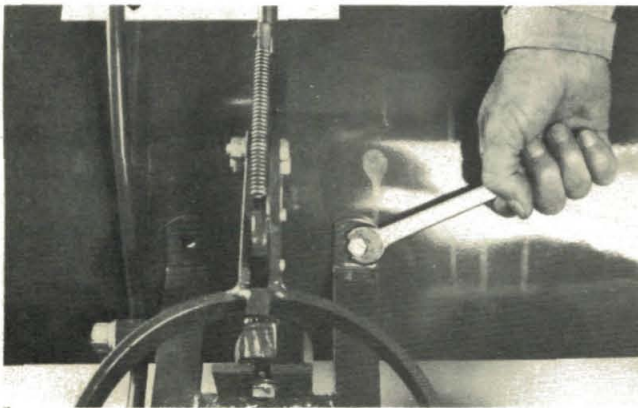

(Photo 8/40) Two front hood bracket bolts.

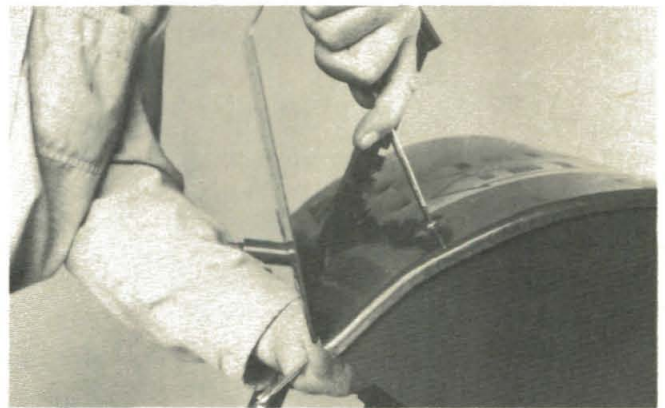

(Photo 8/41) Four rear hood bracket bolts.



(Photo 8/42) Tap knob off, save tolerance ring.



(Photo 8/43) Lift hood off.

BOLO TINES

Assembly On Holders

A complete set of Bolo Tines consists of 2 holders, 16 tines (8 left hand and 8 right hand tines), and 16 each of bolts and locknuts for assembly; a set of 3 washers and a nut for the tine mounting stud to attach the tines and holder to the tiller shaft.

To assemble tines properly please look at the difference between a left hand and a right hand Bolo Tine in Sketch 8/44). In the upper right of the sketch, tines are held up with the blunt edge toward you. From this point of view, a Bolo Tine that bends to the right is a right hand tine. A Bolo Tine that bends to the left is a left hand tine. It's that easy! Also, tines are generally stamped 1270L (or 70L) for Left hand tines, and 1270R (or 70R) for Right hand tines.

ASSEMBLING THREE "A" GANGS

Step 1. Now collect the tines, bolts and locknuts together in groups. (Note: replacement tine gangs will come to you with a lock washer and a free running nut for each tine bolt, instead of a bolt and a locknut, since it's easier for you to assemble that way.)

Place all of the left hand tines in a stack with their tips facing down on a table or bench, as shown in Photo 8/45. You'll note that the tines have their tips to your left and their blunt edges toward you.

Next, place all of the right hand tines on the table, so that their tips are farthest away from the surface of the table. See Photo 8/45.

Step 2. Then, place two left hand tines in front of you, as shown in Photo 8/46. Be sure the tips point down on the table.

Next, lay two right hand tines over them with the tips pointed up, away from the table. As shown in Photo 8/47 and in Sketch 8/48, the cutting edges of the tines should all be facing in the same direction (arrows in sketch show direction of rotation of cutting edges). If they aren't facing correctly (the red arrow in Sketch 8/49 indicates how it would look if one tine is facing in the wrong direction), then the gang is assembled incorrectly and you should review the assembly instructions up to this point.

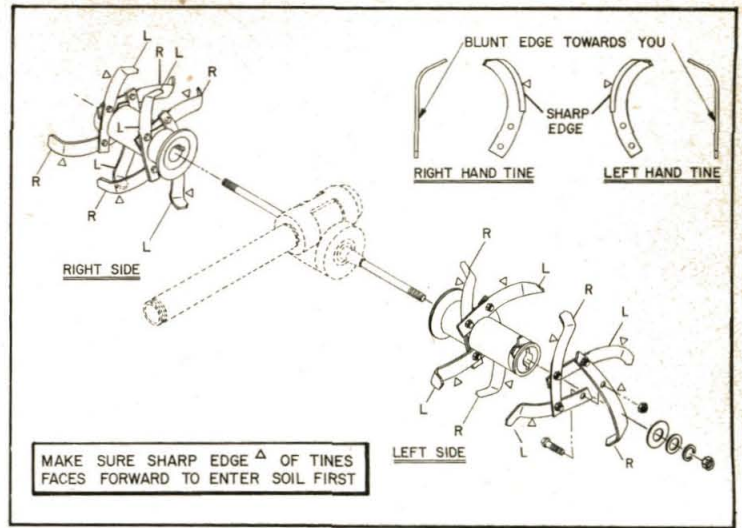

(Sketch 8/44) Viewed from front of tiller.

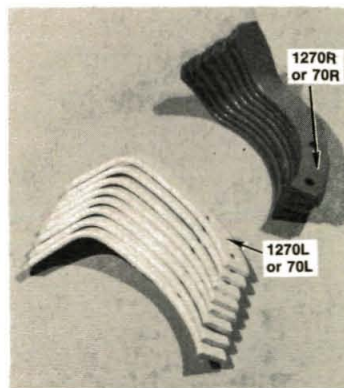

(Photo 8/45) Bolo tines.

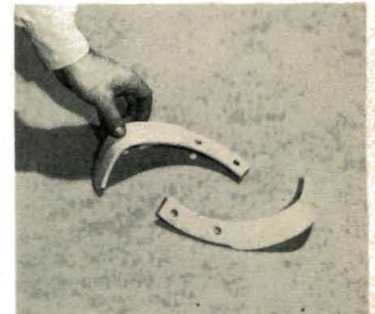

(Photo 8/46) Tips down.

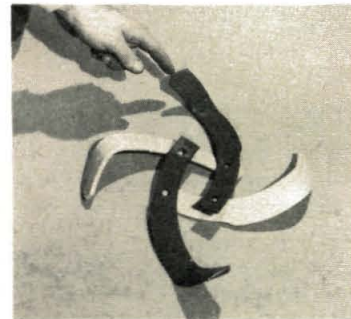

(Photo 8/47) Next, tips up.

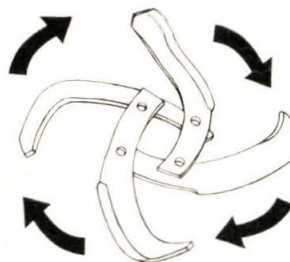

(Sketch 8/48) Tines facing correctly.

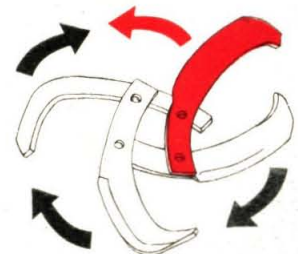

(Sketch 8/49) One tine facing wrong direction

Step 3. Now put a bolt through the holes in the tines, as shown in Photo 8/50, and put on a locknut. Put on three bolts and locknuts, but don't tighten them. They must be very loose during installation on the holders. Don't install the fourth bolt until you install the gang around the holder.

Once you have assembled 4 tines with 3 bolts in what we'll call an "A" gang, make two others just like the first one. Then take a crayon, a marking pen or a small piece of paper and put the letter "A" on the face of one tine in each gang.

Looking at Photo 8/51, you can see that **your tiller will use four gangs of tines—three "A" gangs and one "B" gang.**

You'll also notice in Photo 8/52 that the empty tine holders are shown in back of the tiller transmission with four separate positions marked [1, 2, 3 and 4]. Each position is also marked with an "A" or a "B" to show which type gang of tines goes there.

From the photo, you can see that the "A" gangs go in positions 2, 3 and 4, and the "B" gang goes in position 1, on the far left side of the tiller.



(Photo 8/50) Add three bolts.

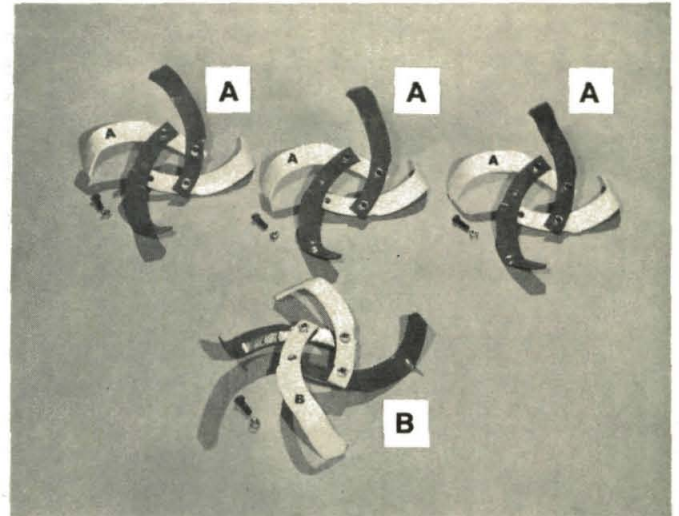

(Photo 8/51) Three "A" gangs and one "B" gang

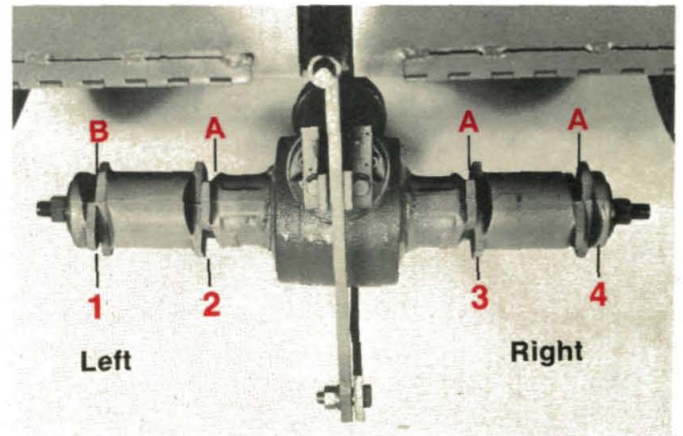

(Photo 8/52) Gang positions on tine holders.

ASSEMBLING ONE "B" GANG OF TINES

Step 1. Please look at Photo 8/53 and take two right hand tines and place them tips up, horizontally in front of you. Then lay two left hand tines (with tips down) over the other tines, as shown in Photo 8/54.

Step 2. With the tines in place (cutting edges of tines facing in the same direction), pass the bolts through both tines at each location, as shown in Photo 8/54. Loosely assemble the gang and mark with a "B". The fourth bolt doesn't go on until you put the tines around the holder position.

With three "B" gangs and one "A" gang as shown in Photo 8/51, you're ready to install the tines on tiller.

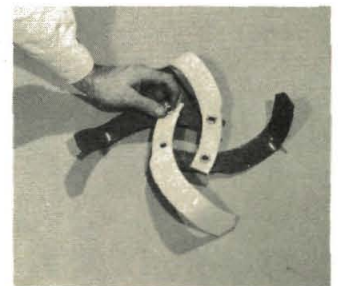

(Photo 8/53) "A" gang. (Photo 8/54) Bolt loosely.

INSTALLING BOLO TINES

Each gang must be installed in the correct location, shown in Photo 8/52, and must go on so that the cutting edges of the tines go into the soil first as the tiller moves forward.

Step 1. Take any Bolo gang marked with an "A" (as shown in Photo 8/51). Use this gang for position three. Make sure all bolts are as loose as they can be without falling off. It's far easier to install the gangs at the inside positions (positions 2 & 3) before installing tine gangs at the outside position (position 4), and later, at position 1.

IMPORTANT

Please be certain that the three gangs marked with an "A" are in positions 2, 3 and 4 and the gang marked with a "B" is in position 1. Make sure that the cutting edges of the tines enter the soil first, not the tips. Tines rotate in the same direction as the wheels. Photo 8/55 shows a tiller with the hood removed so that you can see tines facing in the proper direction.

Step 2. Wrap the "A" gang of tines around position 3 of the tine holder. Rotate the gang of tines until the two inner (left hand) tines are around one lug, and outer (right hand) tines are around the other lug. The gang can only go on the holder one way—as long as the tines are installed so they rotate in the correct direction so the blade strikes the ground first. See Photos 8/55 and 8/56.

Step 3. Put a bolt through the two remaining tine holes once you have them aligned, as shown in Photo 8/57. Add a locknut and tighten with two 9/16" wrenches.

Follow the same procedure to install the remaining two "A" gangs in positions four and two, see Photo 8/58. Then install a "B" gang in position one—see Photos 8/59, 8/60 and 8/63.

Step 4. If you have trouble lining up the holes, use a screwdriver placed through the bolt holes to pry the tines in the proper direction. See

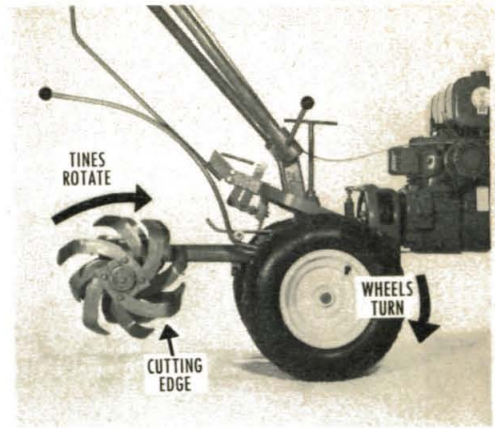

(Photo 8/55) Tine rotation.

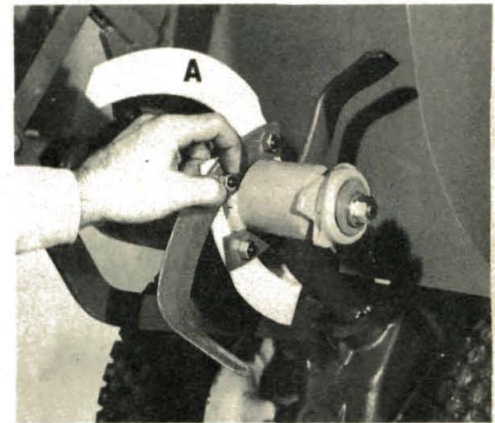

(Photo 8/56) "A" gang at position 3.



(Photo 8/57) Install an "A" gang



(Photo 8/58) Gang of tines marked with an "A" installed at positions 3 & 4. An "A" gang also goes at 2.

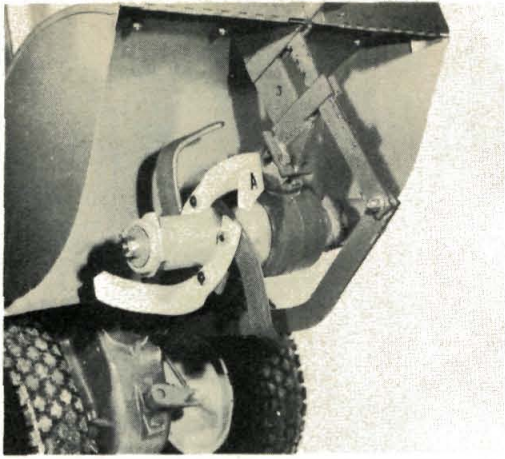

(Photo 8/59) "A" gang at position 2.

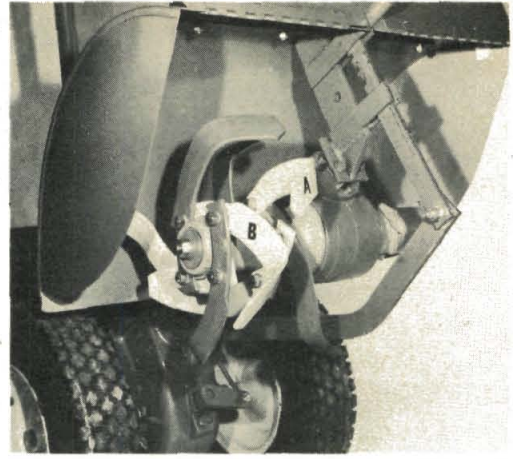

(Photo 8/60) "B" gang at position 1.

Photo 8/61. Or, use a mallet to give the tines a light tap in the proper direction. Make sure that the nuts are very loose and pinch the tines together when you get them close to being aligned.

Step 5. If all attempts to align the two bolt holes of tines on a gang of tines in Step 4 have failed,

remove the tine holder nut marked with an arrow in Photo 8/61. Then remove the tine holder.

Look at the holder for tiny rough edges of the iron casting in the groove between the tabs. See Photo 8/62. Smooth these rascals out of there with a metal file or small grinding wheel. Now, go back to Steps 2 and 3.

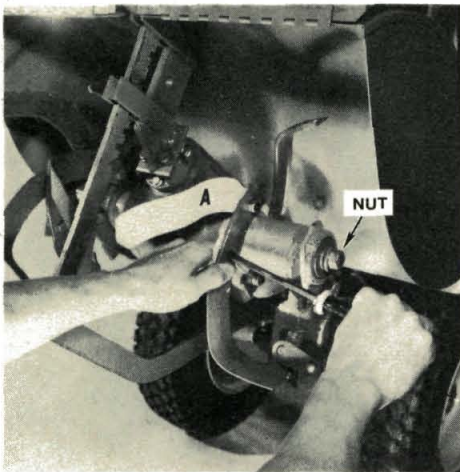

(Photo 8/61) Pry tines to align holes.

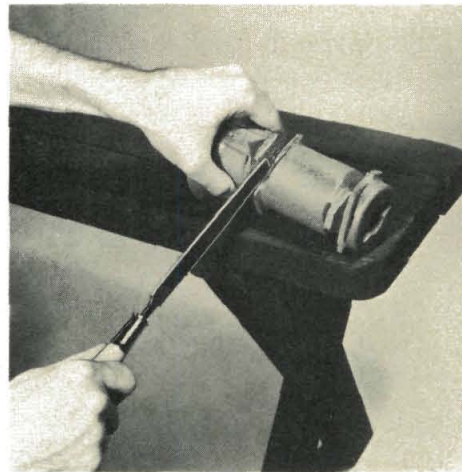

(Photo 8/62) File rough spots in groove.

Here's what your complete Bolo Tine assembly will look like.

Notice, in Photo 8/63, the "A" gangs are on positions 2, 3 and 4, and the "B" gang is on position 1.



(Photo 8/63) Three "A" gangs at positions 2, 3, & 4 and one "B" gang.

REMOVING BOLO TINE GANGS

1. Disconnect spark plug wire and shift tiller control levers into Neutral. Then use 2 wrenches to remove one bolt from a tine gang—see Photo 8/64A.
2. For stubborn nuts, oil and use two wrenches; try another nut. And finally, tap down with a mallet (Photo 8/64B) if needed.
3. When nut and bolt are removed, tap tine up, as shown in Photo 8/64C, to open up gang and remove it.
4. Repeat steps 1, 2 and 3 on other three gangs—see Photo 8/64D.



(Photo 8/64A) Remove one bolt.

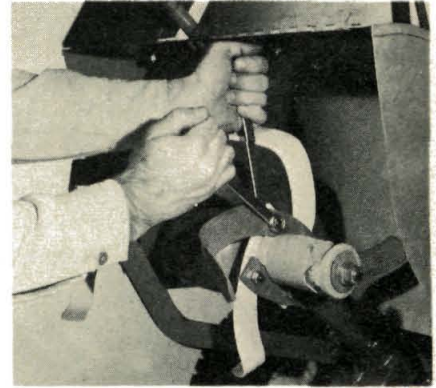
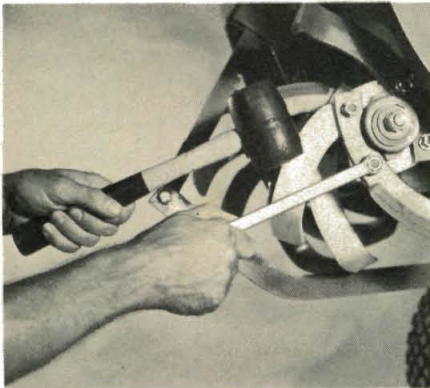

(Photo 8/64B) First, oil tight nuts. (Photo 8/64C) Tap tine to open. (Photo 8/64D) Repeat for inside.

REMOVING BOLO TINES & HOLDERS

1. Use $\frac{3}{4}$ " wrench to remove tine nut shown in Photo 8/65A. Photos show removal of tine assembly on right side.
2. Tap tine outward (Photo 8/65B) to loosen holder.

3. Grasp tine stud on unthreaded portion (Photo 8/65C) and push down to loosen on right side (up to loosen left side) of tiller.
4. Replace key in tiller shaft keyway (Photo 8/65D). Look in holder if it is not in shaft.

Follow same procedure for left side of tiller.



(Photo 8/65A) Remove nut.

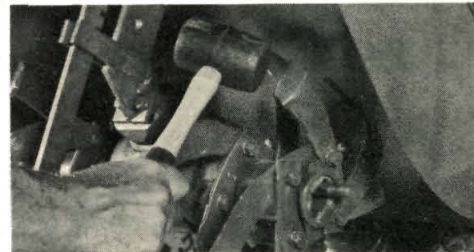

(Photo 8/65B) Tap tines outward.

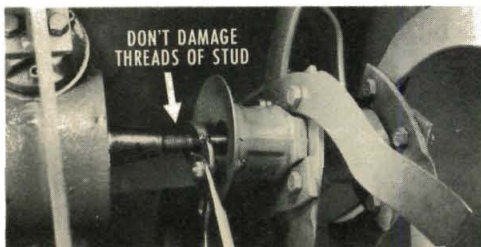

(Photo 8/65C) Pliers loosen stud.



(Photo 8/65D) Replace Key.

CULTIVATING TINES

Replacing & Removing

Here are the parts that make up a set of Cultivating Tines (see Photo 8/67):

- 6 left hand tines, 6 right hand tines.
- 1 inside holder, blunt teeth (left side).
- 1 inside holder, pointed teeth (right side).
- 1 outside holder, pointed teeth (left side).
- 1 outside holder, blunt teeth (right side).
- 6 middle holders, interchangeable.
- 12 clamps, bolts, lock washers and nuts.
- 2 tine studs.
- 2 nuts and washers for mounting tines on tiller.

ASSEMBLING CULTIVATING TINES ON HOLDERS

1. To determine whether a tine is left or right, you hold it by the end of the "U" bend with the blade side away from you and pointing upward. You will then see that the first bend of the blade takes it to your left or right. That first bend away from the center line determines whether it is a left or right hand tine. (See Photo 8/68).

2. Divide twelve tines into two groups of six left and six right.

3. Sort the tine holders out, as shown in Photos 8/69A and 8/69B. Locate right hand inside holder (Photo 8/69B). It will hold two tines and has pointed teeth. Also, see pointed vs. blunt teeth in Sketch 8/70.

START WITH RIGHT HAND SIDE OF TILLER

4. START ASSEMBLING WITH RIGHT HAND INSIDE HOLDER. Mount a right hand tine on the flat side of the holder and a left hand tine on the teeth side of the holder—see Photo 8/71.

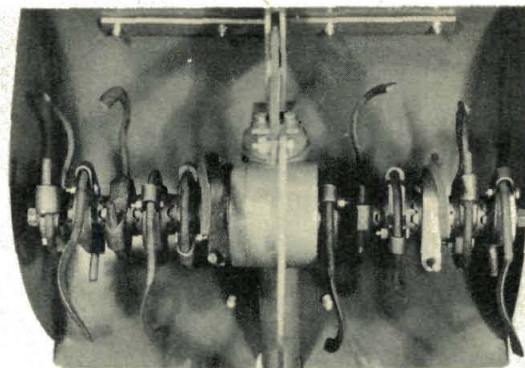

(Photo 8/66) Cultivating Tines installed on tiller.

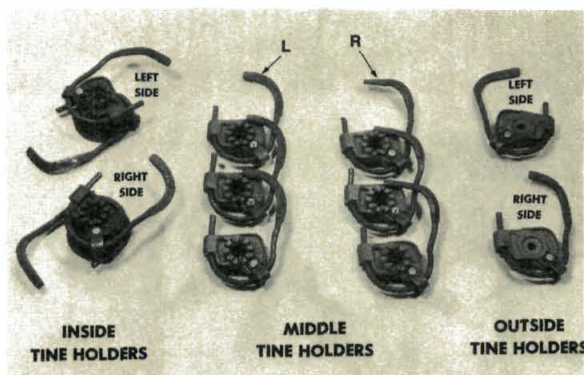

(Photo 8/67) Complete set (without studs).

8

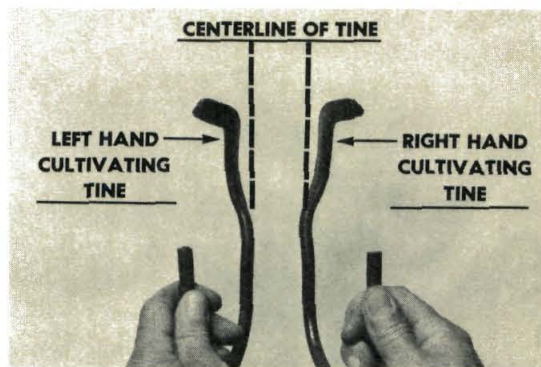

(Photo 8/68) First bend from line tells.

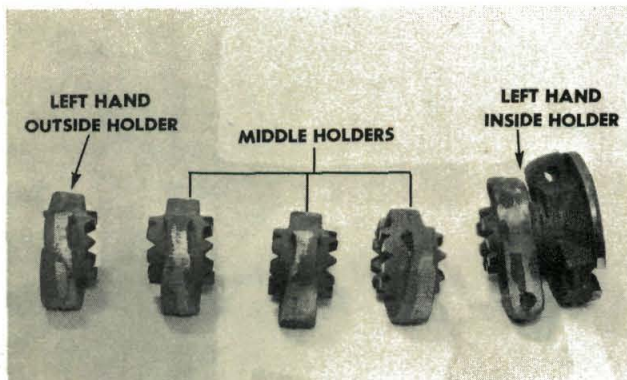

(Photo 8/69A) Holders on left side.

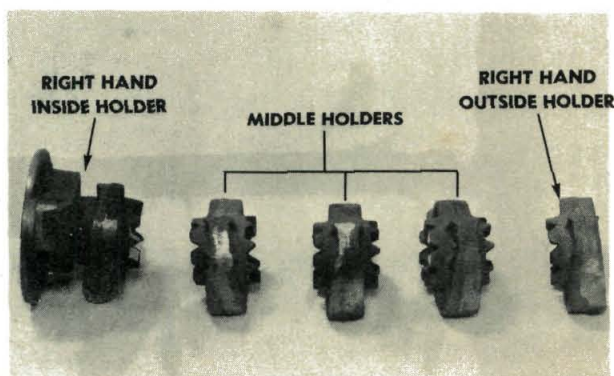

(Photo 8/69B) Right side, from operator's view.

5. The tines rotate in the same direction as the wheels. When moving the tiller forward, notice how the knife-like edge of the Cultivating Tine in Photo 8/72 goes into the ground first.

6. A tine is mounted on the holder by inserting the blunt end of the tine into the holder (Photo 8/73A). The tine is held in place by a "U" clamp (#1045 tine clip)—see Sketch 8/73B—with the bolt going from the outside toward the center of the holder. Use a lock washer and nut. Tighten with two 7/16" wrenches as shown in Photo 8/73C. **Please note:** On the inside tine holders it is not possible to have both bolts facing inward—the bolts will head toward each other.

7. If the right hand inside holder has been assembled correctly, the two tines will bend toward each other (Photo 8/71).

Note: For the *left hand* inside holder, you will mount a left hand tine on the flat side of the holder, and a right hand tine on the teeth side of the holder. For Cultivating Tines, the innermost tine on the inside holder always bends away from the tiller housing.

8. All tines should be mounted on holders before assembling the tine set on the tiller. When fully assembled, you will have two inside holders (one right hand and one left hand side), three middle holders with left hand tines, three middle holders with right hand tines, and a right and left hand outside holder. (See Photo 8/67). The outside holder on the right takes a left hand tine, and the outside holder on the left takes a right hand tine.

REPLACING CULTIVATING TINES AND HOLDERS ON TILLER

Right Hand Side

1. Fit the right hand inside holder against tiller housing (Photo 8/74) so that the slot on the inside of the holder fits over the key in the shaft. Tap into place. Be sure that the inside holder is installed on the tiller shaft so that the blade portion of the Cultivating Tine will strike the ground first, not the tip of the tine first (see Photo 8/72).

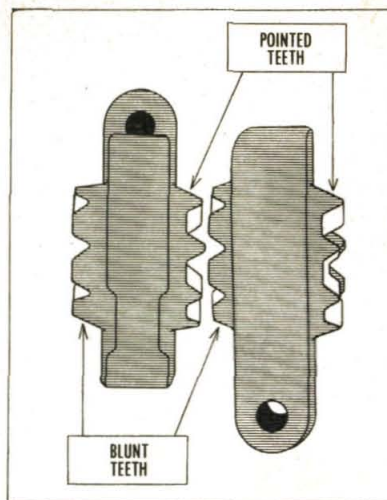

(Sketch 8/70) Middle tine holders have blunt teeth on one side and pointed teeth on the other.

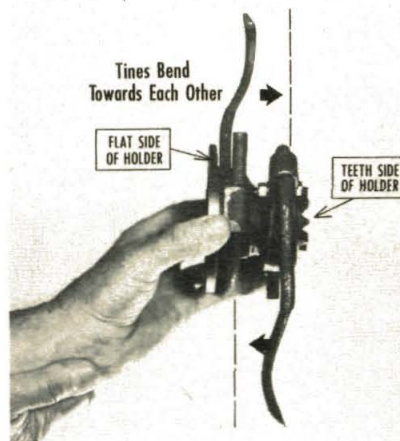

(Photo 8/71) Inside holder



(Photo 8/72) Cutting edge of these hits soil

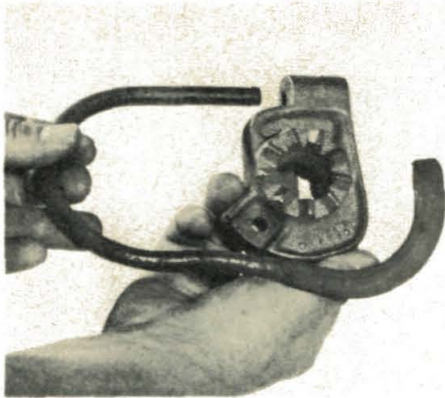

(Photo 8/73A) *Insert tine.*

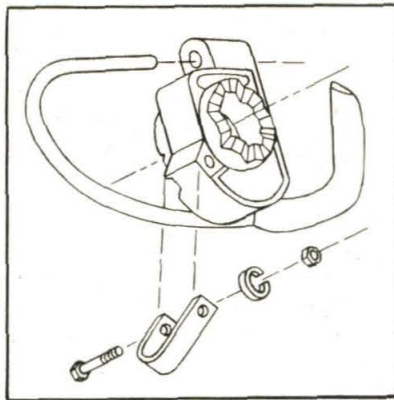

(Sketch 8/73B) *Tine clamp.*

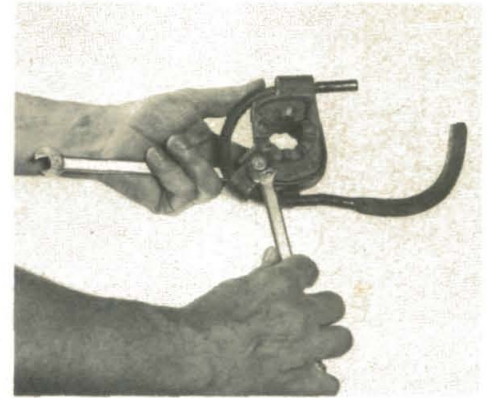

(Photo 8/73C) *Two wrenches tighten.*

2. Grease the threaded end of a stud and insert it into the shaft. Tighten firmly with plier. (Photo 8/75.)

3. Take a middle holder with a right hand tine. When you slide the holder onto the stud, blunt teeth inside first (see Sketch 8/70 and Photo 8/67), the tine will bend away from the inside holder. **Note:** It is best to hold this in place as you install each successive tine holder.

4. The next middle holder also goes on blunt teeth side first with a left hand tine.

5. If the two middle holders are correct, their tines will bend toward each other. (Photo 8/76 and Sketch 8/70).

6. The third middle holder goes on blunt teeth side first with a right hand tine.

7. The outside holder with a left hand tine goes on blunt teeth side first (flat side out).

8. Tines on the outside holder and the nearest middle holder should be bending toward each other.

9. Follow Photo 8/77 from **A** through **E**, and arrange the tines in a "pin-wheel" effect by aligning each successive tine up, as shown by the numbers in the photos. Please note that no two tines on the right side should strike the ground at the same time.

10. When the holders are positioned, replace the lock washer and tighten the nut.

FOR LEFT HAND SIDE OF THE TILLER: The installation of tines and holders on the left side is accomplished simply by using the right side as a pattern. Start with the left hand inside holder and follow the ten steps in "Replacing Tines and Holders on Tiller."

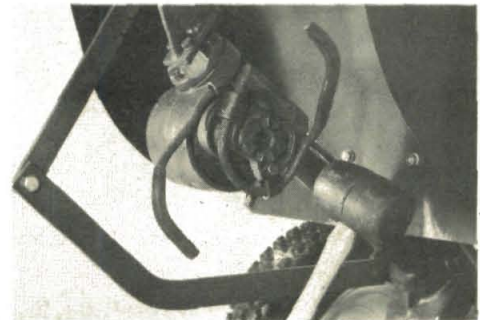

(Photo 8/74) *Install inside holder.*



(Photo 8/75) *Pliers tighten stud.*

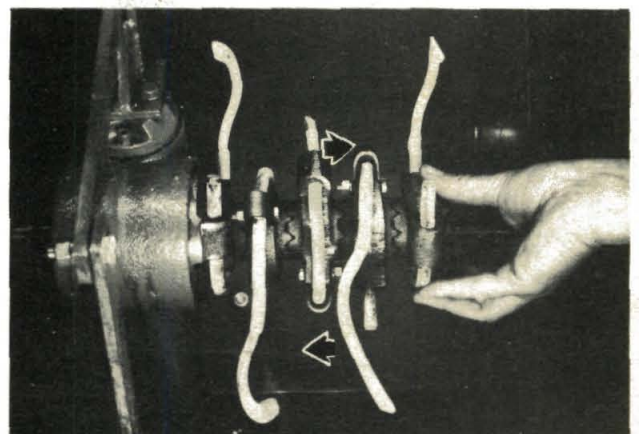

(Photo 8/76) *Middle holders installed*

(Photo 8/77)

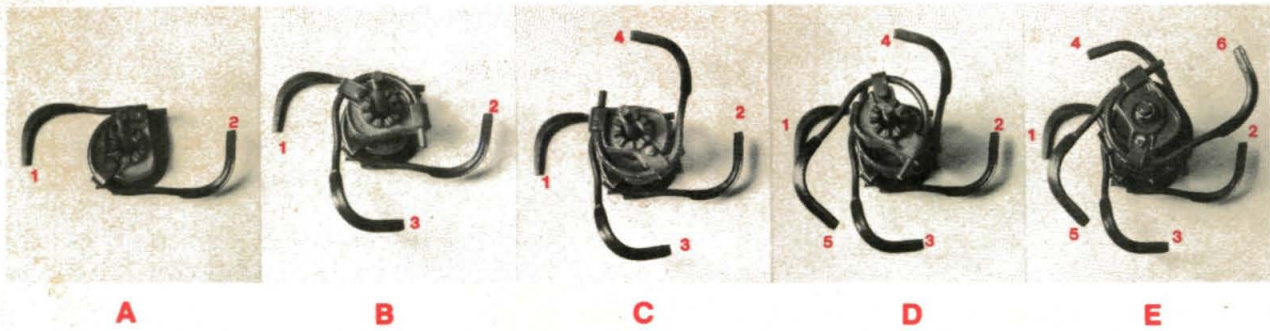

REMOVING CULTIVATING TINES

First, tilt your tiller up on its engine, taking care to place something underneath the engine shroud to protect it from damage. Then, take a $\frac{3}{4}$ " wrench and remove the tine nut (Photo 8/78) and the lock washer. Next, remove two or three holders from the tine assembly. This will give you room to get at an unthreaded portion of the tine stud. Use a pair of pliers or vise-gripping pliers to unscrew the tine stud counterclockwise and remove it from the tiller shaft (Photo 8/75). The remaining tine holders and tines will drop to the ground. You can tap the last holder off the shaft.

POINTED PICK TINES

Replacing & Removing

A complete set of Pointed Pick Tines consists of the same parts as a set of Cultivating Tines (see page 142, paragraph 1), except all twelve Pointed Pick Tines bend in an "S" shape. There are no left or right hand tines—see Photos 8/79 and 8/80.

ASSEMBLING PICK TINES ON HOLDERS— FOR RIGHT HAND SIDE OF TILLER

1. Please remember that the pointed tip (pick end) of the tine always enters the ground first when the tiller moves forward (Photo 8/81).
2. Sort the tine holders out, as shown in Photos 8/69A and 8/69B, on page 142. Locate the right hand inside holder (Photo 8/69B, page 142). It will hold two tines and is flat on the inside and has pointed teeth facing outward. To identify pointed vs. blunt teeth, please see Sketch 8/70 on page 143.



(Photo 8/78) Remove nut and washer.

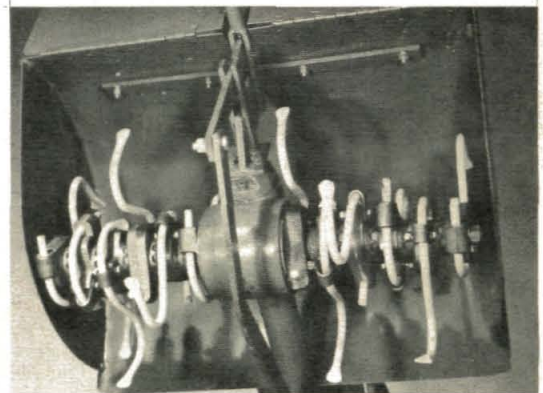

(Photo 8/79) Pointed Pick Tines installed on the tiller.

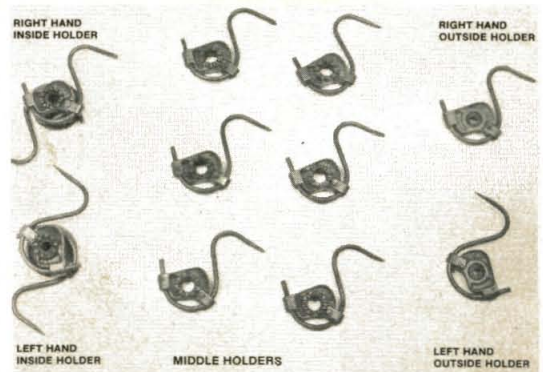

(Photo 8/80) Set of pick tines and holders.

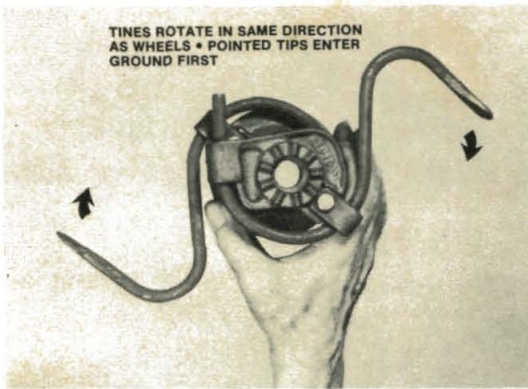

(Photo 8/81) *Tips strike soil first.*

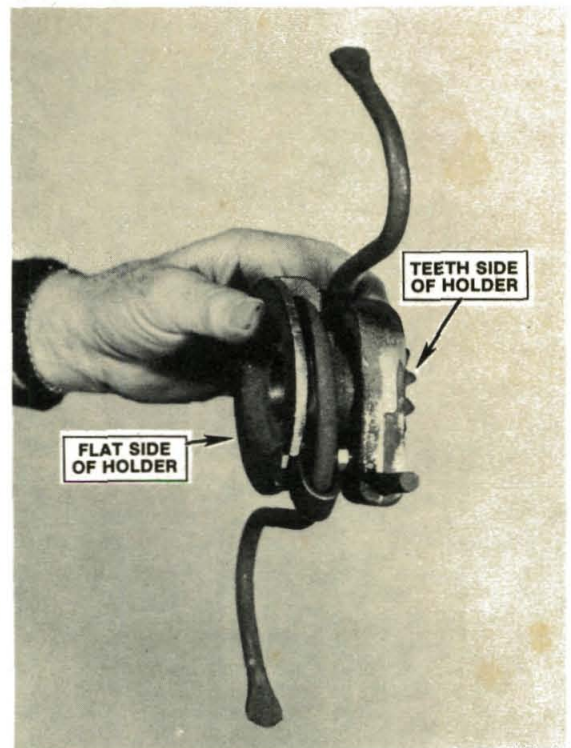

(Photo 8/82) *Inside holder, right side.*

3. Mount a tine on the flat side of the holder and another tine on the teeth side of the holder (Photo 8/82). A tine is mounted on the holder by inserting the end opposite the pick in the holder (Photo 8/83). The tine is held in place by a "U" clamp (#1045 tine clip), Sketch 8/84; with the bolt going from the outside toward the center of the holder. Use a lock washer and nut. Tighten with two 7/16" wrenches—see Photo 8/85. **Note:** On the inside tine holders, it is not possible to have both bolts facing inward—the bolts will head toward each other.

4. If the inside holder has been assembled correctly, when traveling forward, the pointed picks of the two tines will enter the ground first as the tines rotate in the same direction as the wheels (Photo 8/81).

5. All tines should be mounted on holders before installing the assembled tines and holders on the tiller.

8

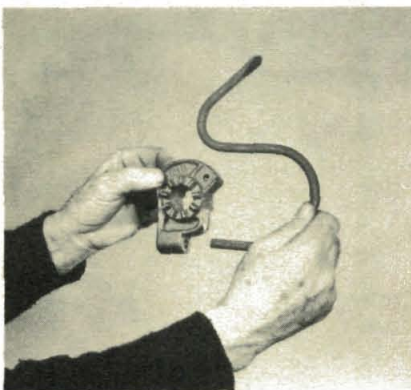

(Photo 8/83) *Insert tine.*

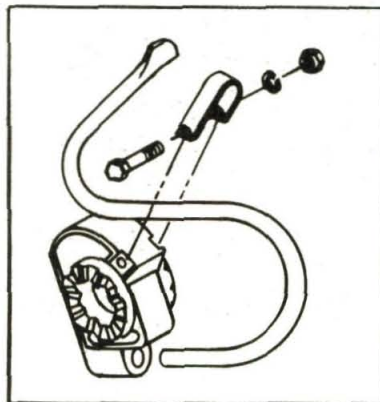

(Sketch 8/84) *Put on clamp.*

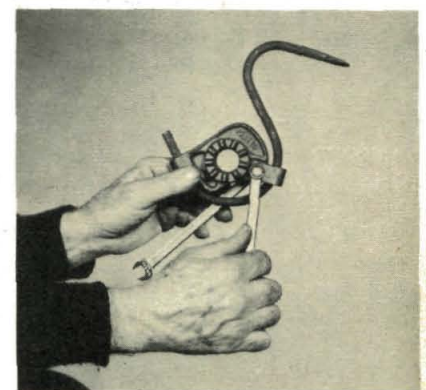

(Photo 8/85) *Tighten bolt and nut.*

REPLACING PICK TINES AND HOLDERS ON TILLER

1. Fit the assembled right hand inside holder against the tiller housing (Photo 8/86) so that the slot on the inside of the holder fits over the key in the shaft. Tap into place.
2. Grease the threaded end of the stud and insert it into the shaft. Tighten firmly with pliers, taking care not to touch the threads on the stud with the pliers (Photo 8/87).
3. Place three middle tine holders on the stud—blunt teeth side first. Note how the blunt teeth fit into the spaces between the pointed teeth of each holder.
4. Place the right hand outside holder on the stud, with the blunt teeth side first. The flat side (without teeth) of the outside holder will be facing outward—see **A** in (Photo 8/88).
5. Now check to be sure that the pointed picks of the tines are all facing so that the tips will enter the ground first when the tiller moves forward.
6. The inside holder is fixed in place, but the three middle and the outside holders must be positioned in a staggered or “pin-wheel” effect so that no two tines on the right hand side will touch the ground at the same time (Photo 8/88).
7. When the holders are positioned, replace the lock washer and tighten the nut (Photo 8/89).

FOR LEFT HAND SIDE OF TILLER

To install tines and holders on the left hand side, simply repeat the 5 steps outlined above under “Assembling Pick Tines On Holders,” and the 7 steps in “Replacing Pick Tines And Holders On Tiller.” Please note that on the left side, the holders will have blunt teeth (facing outward), which will match up with the pointed teeth of each succeeding holder.

REMOVING PICK TINES

First, tilt your tiller up on its engine, taking care to place something underneath the engine shroud to protect it from damage. Then, take a 3/4" wrench and remove the tine nut (Photo 8/89) and the lock washer. Next, remove two or three holders from the tine assembly. This will give you room to get at an unthreaded portion of the tine stud. Use a pair of pliers or vise-gripping pliers to unscrew the tine stud counterclockwise and remove it from the tiller shaft (Photo 8/87). The remaining tine holders and tines will drop to the ground. If necessary, you can tap the last holder off of the shaft. Don't lose the key in the shaft.

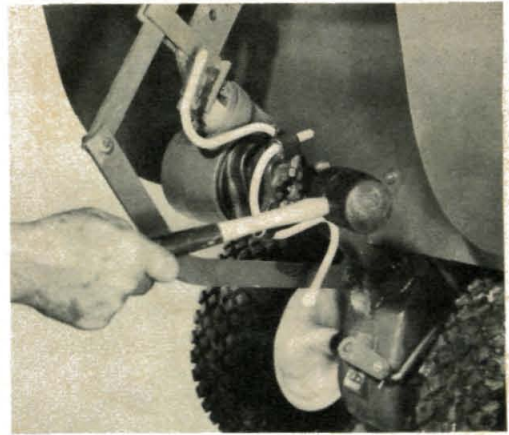

(Photo 8/86) Tap on holder.



(Photo 8/87) Install tine stud.

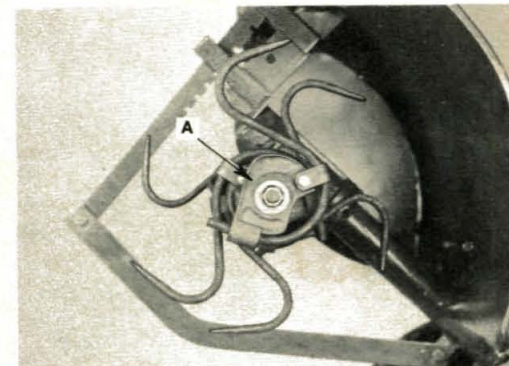

(Photo 8/88) Pick tines, right side.

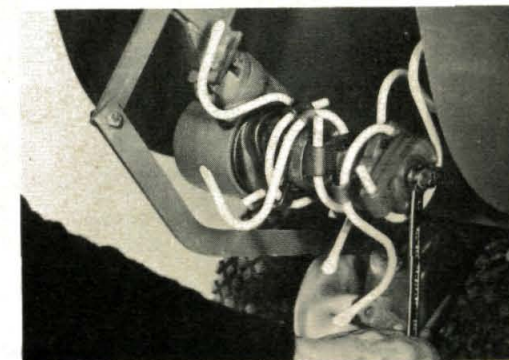

(Photo 8/89) Tighten tine nut.

REMOVING THE ENGINE FROM THE TROY-BILT HORSE MODEL

Removing the engine from your tiller, to repair or replace the engine, or to repair internal tiller transmission parts, is not as complicated as it might seem. Briefly, here are the few simple steps that you will have to take. Below are more complete details of each step.

First, you will have to disconnect the throttle wire from the engine. Then, you will have to remove the reverse disc (part #1072). Then, you must remove the engine mounting bars (part # 1034). Finally, you will have to remove the engine by lifting it, and its mount, up and away to clear the lower pulley. Before you remove the engine, however, it is best to remove the belts, in accordance with the belt changing instructions in Section 7 of this manual.

REMOVE THROTTLE CABLE— 6HP TECUMSEH ENGINE

As shown in Photo 8/90, loosen the throttle cable mounting clip and lift the cable out of the clip. Then, disconnect the throttle wire from the speed control lever at the carburetor, without

bending the tip of the wire out of shape. Remember, it's extremely difficult to rebend the shape at the end of the throttle wire, so treat it accordingly. Be careful not to kink or bend the throttle cable when it is freed. Loop the cable backwards and tuck it out of the way.

SKIP NEXT STEP IF IT DOES NOT APPLY TO YOUR TILLER

Only if your tiller has an electric Start Engine:

1. Disconnect the positive battery terminal from the cable on top of the battery and the negative terminal from the cable at the bottom of the 8¼" long bolt clamping the battery down. Remove the bolt and lift the battery out of the bracket, as shown in Photo 8/91.

2. Then disconnect the terminal at the bottom of the key switch (**A** in Photo 8/91.). Next, separate the terminals (**B** in Photo 8/91) that connect the green ground wire to the key switch and the diode and fuse to the solenoid. Do this as shown in Photo 8/92.

8

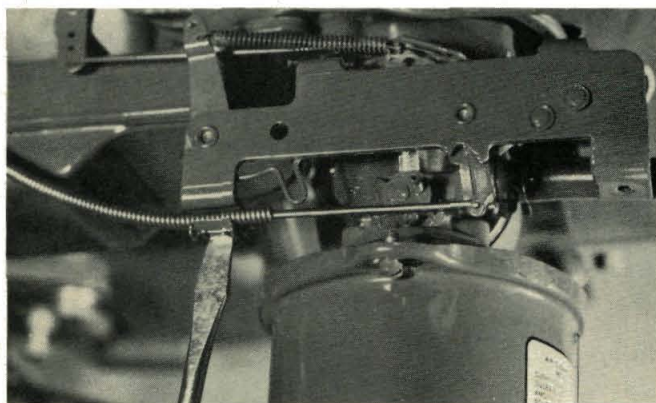

(Photo 8/90) Throttle cable removal.

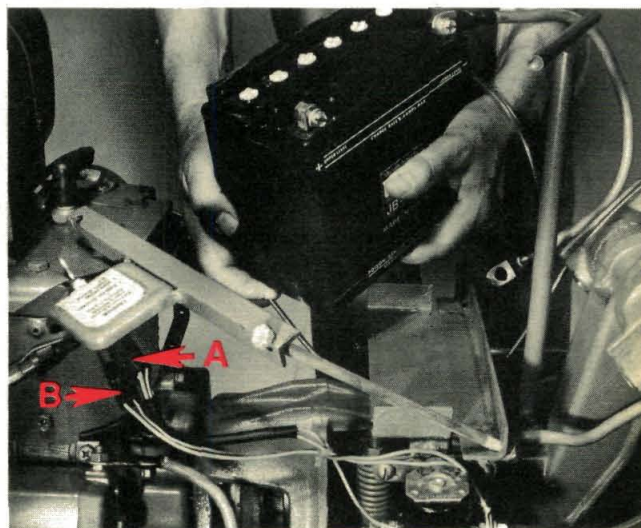

(Photo 8/91) Remove battery.

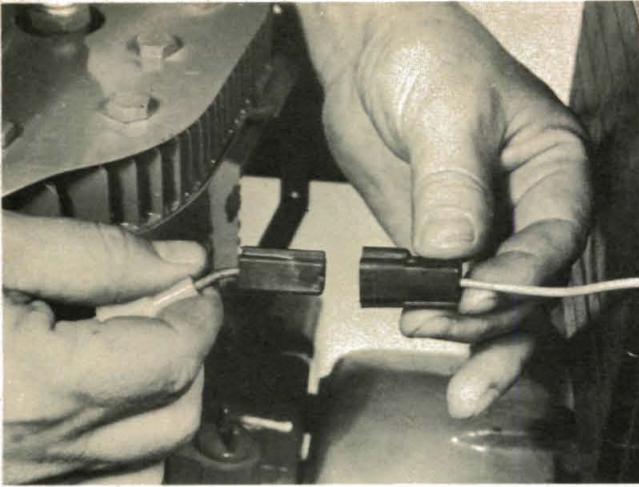

(Photo 8/92) *Disconnect recharging wire.*

4. Finally, remove the two screws (part #9713) from the bottom of the battery bracket (see Photo 8/94) and remove the battery bracket (cables and all) from the tiller—see Photo 8/95. Replace the two screws (part #9713) in the top of the transmission cover.

NOTE: Be careful not to let any wires or metal touch the battery terminals while putting the battery assembly safely aside.

3. Next, disconnect the red cable from the top of the starter motor on the engine—replacing the nut for safekeeping—see Photo 8/93.

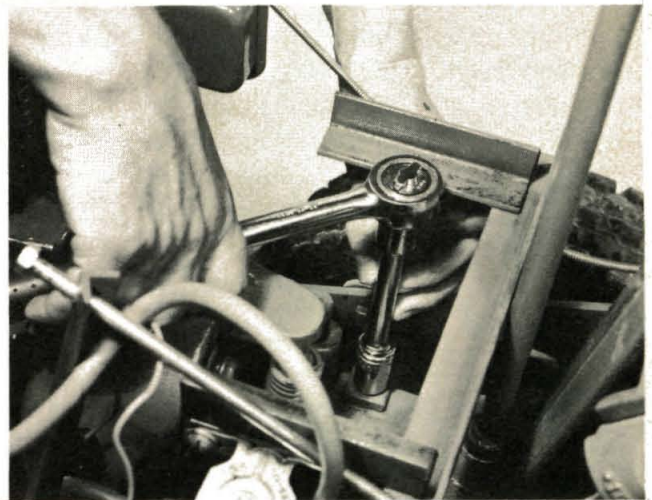

(Photo 8/94) *Remove battery bracket.*

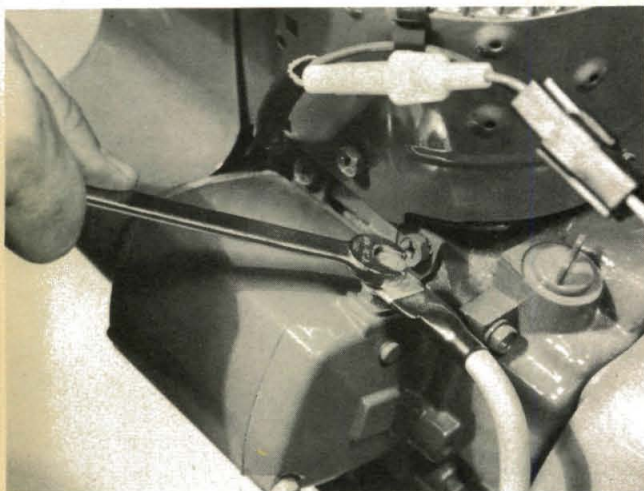

(Photo 8/93) *Cable to starter.*

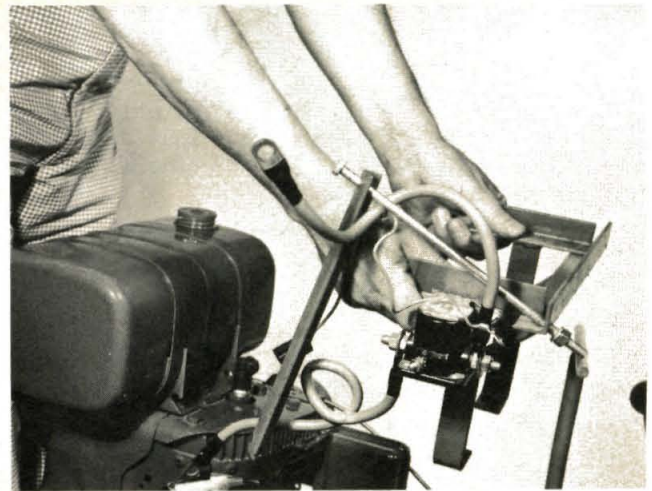

(Photo 8/95) *Bracket and all.*

ALL ENGINES

Remove the Reverse Disc—Shift the Forward/Reverse Lever into Forward position to raise the reverse disc. Remove the mounting bolt and plate—see Photo 8/96. Then, remove the reverse disc out the side between the reverse plunger and the front of the engine mount, as shown in Photo 8/97.

Remove the Belts—Remove the belts, in accordance with the belt changing instruction in Section 7 of this manual.

Detach the Yoke—Remove the bolts that fasten the control yoke (part #1037) to the engine mount—see Photo 8/98. Next, remove the engine mount bars. Remove the bolts that lock the engine mount bars (part #1034) into position—see Photo 8/99. First, loosen the jam nut and then unscrew the bolt almost all the way out. With a solid support placed under the engine, tap each mount bar down to remove the bar from the housing. A screwdriver and mallet can be used for this purpose—see Photo 8/100.

Now, the engine and its housing are free to be removed from the tiller.

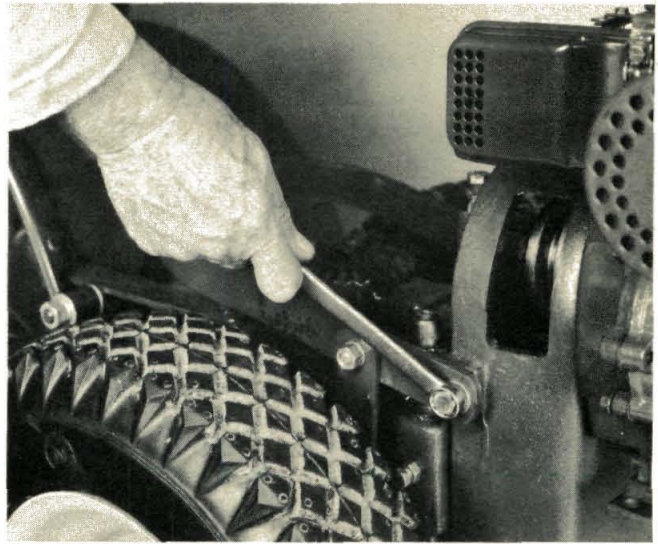

(Photo 8/98) Yoke is bolted to engine mount.

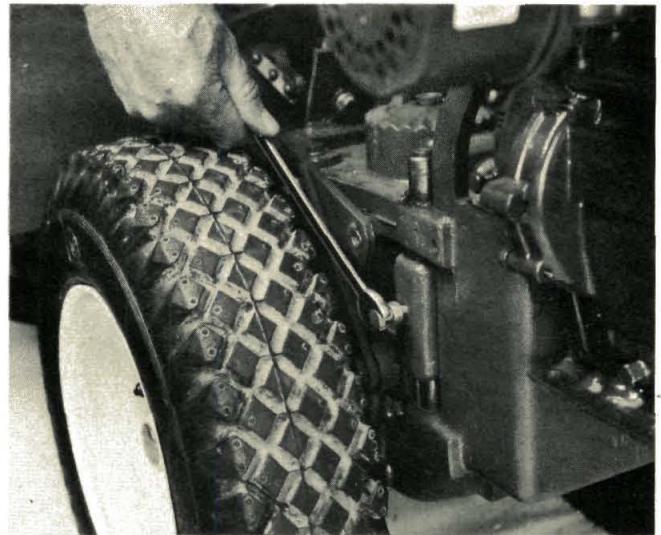

(Photo 8/99) Unlock engine mount bars.

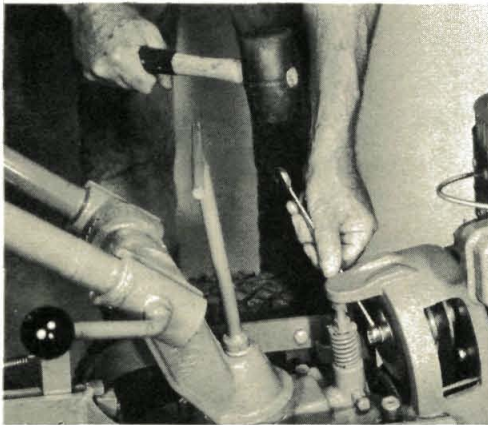

(Photo 8/96) Remove disc bolt.



(Photo 8/97) Remove disc.

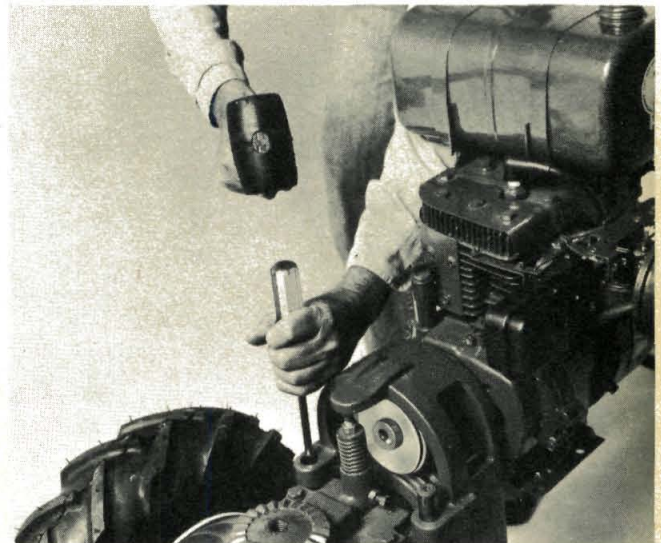

(Photo 8/100) Drive bars out.

LIFT AND REMOVE ENGINE ASSEMBLY (ALL ENGINES)

Prepare for removal of the engine by having ready a cement block, or a box about 4½" to 12" high, or a clear place on a table ready upon which to place the engine when you take it off the tiller. The 6 H.P. standard engine and mount weigh about 67 lbs.

Lift the engine mount and engine assembly first up, and then towards the front, and away from the tiller. **CAUTION: When you lift up the engine, don't hold it by the air cleaner, or carburetor. You will almost certainly break the carburetor if you do.** Instead, pick the engine up by its steel base with your left hand and by the steel fuel tank mounting bracket with your right hand—see Photo 8/101

Once the engine pulley has cleared about ½" above the lower pulley, you can move the assembly away from the tiller.

With the engine removed, it is a good time to check how well the lower pulley (part #1008-1) floats back and forth on the tiller shaft and whether or not the shaft is lubricated. You can also easily check the play on the main drive shaft by removing the first snap ring retaining the lower pulley. Then, remove the pulley and pull the tiller drive shaft back and forth. Please refer to the shimming instructions about removing play from the tiller drive shaft in Section 8.



(Photo 8/101) Lift with care.

SEPARATION OF THE ENGINE AND ENGINE MOUNT

While the engine and its engine mount have been removed from the tiller, it's an ideal opportunity to check on the engine seal for oil leaks. Please remember that the location of the engine pulley is fairly critical. This pulley must align itself with the lower transmission pulley when mounted on the tiller. The location of the engine pulley also determines the critical alignment of the reverse disc with the transmission pulley below it.

So, be careful to measure the distance from the end of the engine crankshaft to the closest shim. In other words, one or more shims have been put on the engine power-take-off shaft before the engine pulley was installed—see Photo 8/102. So, when you replace the engine pulley, you should maintain the same distance from the engine oil seal to the shim closest to the end of the shaft. Generally speaking, the manner in achieving this is to replace the engine pulley with the same number of shims. Naturally, this may not be the situation if you are switching engines; that is, replacing one engine with another type engine. When replacement engines are supplied from the factory, they are accompanied by additional shims. Also, you may want to remove, or add, shims to get better alignment of the reverse disc with the transmission pulley. (See "All About Reverse" in Section 7 of this manual.)

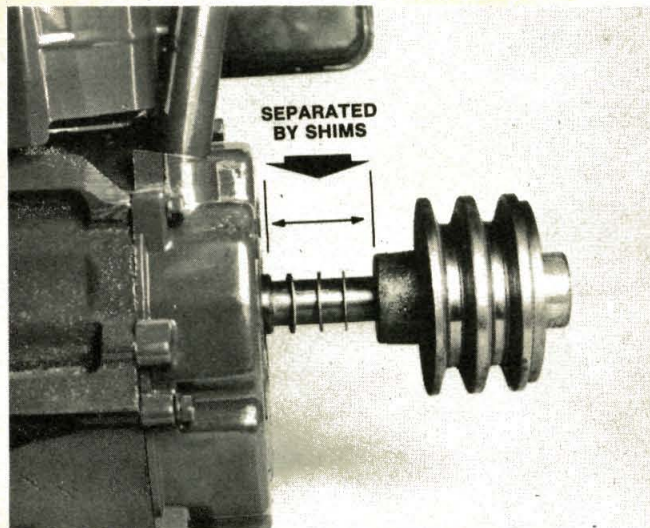

(Photo 8/102) Shims between engine and pulley.

To remove the engine pulley, put a small pry bar or a stiff board behind the pulley and tap it loose. Then remove the pulley as shown in Photos 8/103 and 8/104. As mentioned before, carefully note what size and thickness shims are behind the pulley and the distance from those shims to the front edge of the pulley.

SEPARATING THE ENGINE FROM THE ENGINE MOUNT

With the engine pulley removed, you can now remove the four 5/16" bolts that secure the engine mount (part #1002) to the engine—see Photo 8/105. Please consult your *Master Parts Catalog* for the Horse Model Tiller for the correct bolts and shims used to mount an engine if you are switching to a different type engine.

Let's say you are replacing a 6 H.P. Tecumseh-Lauson engine with a new 6 H.P. Tecumseh-Lauson engine. You can then expect that it will probably be all right to use the same shims behind the engine pulley that were there originally. A final check of alignment of the upper pulley and reverse disc with the lower pulley grooves is the absolute test.

8

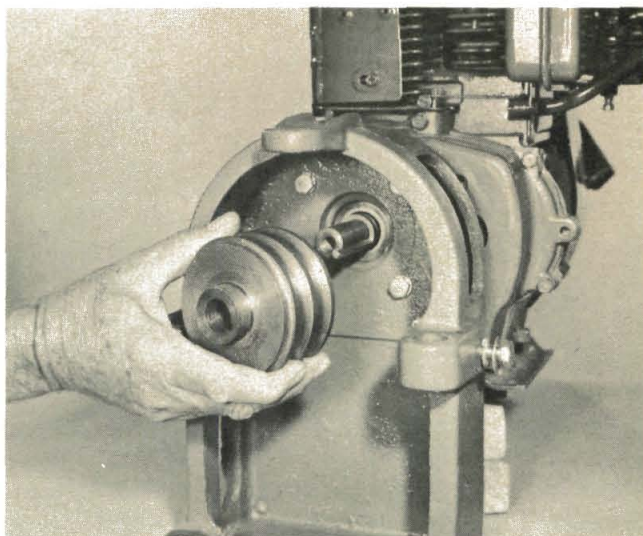

(Photo 8/104) Remove pulley.

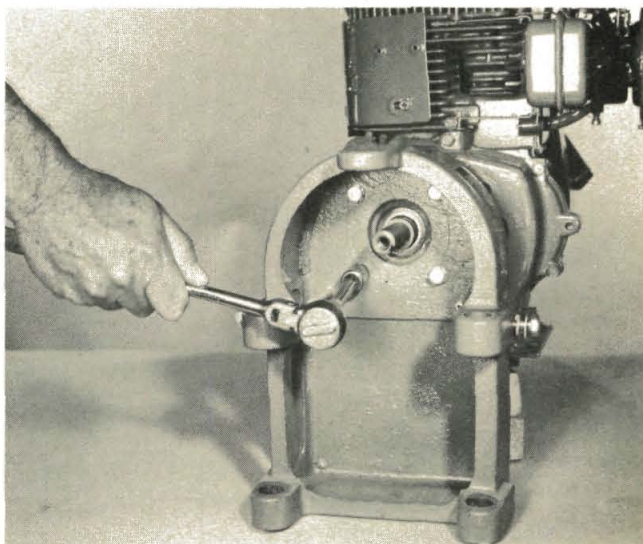

(Photo 8/105) Four bolts on mount.

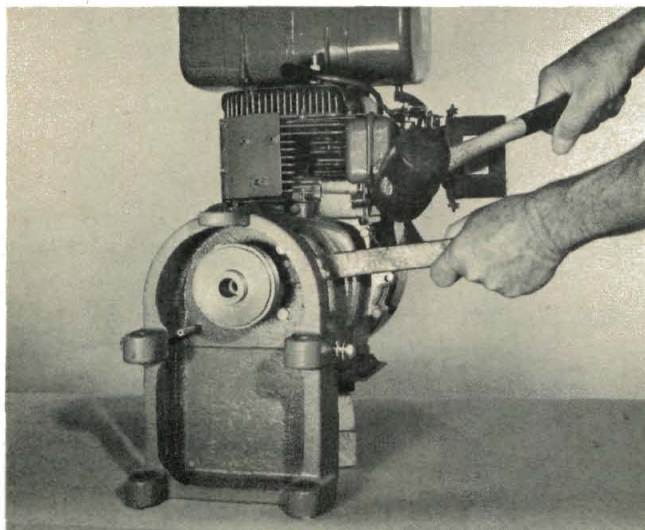

(Photo 8/103) Pry pulley out.

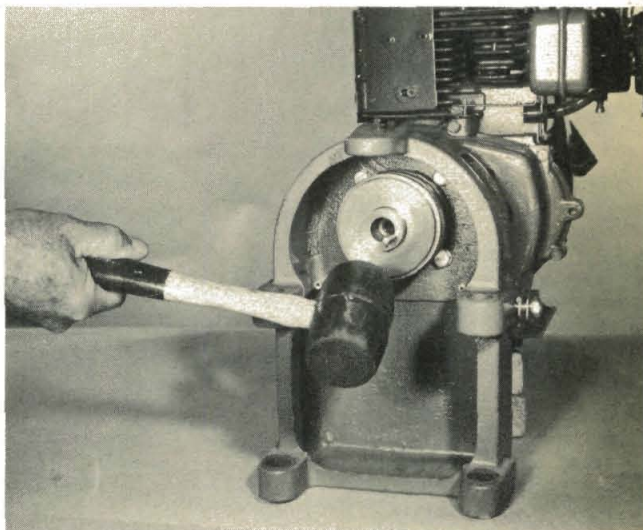

(Photo 8/106) Put on pulley, tap in key.

INSTALLING THE ENGINE ON ITS MOUNT

Reinstall the four 5/16" bolts into the engine mount (6 H.P. engines), shown in Photo 8/105. Then, replace the engine pulley shims and the engine pulley on the engine crankshaft. Insert the key in the keyway by tapping the key in with a mallet or hammer—see (Photo 8/106).

REPLACING THE ENGINE

With the engine pulley and engine mount in place, lift up the engine assembly and set it back in place on the tiller. Align the holes in the engine mount with those in the transmission so that you can replace one of the engine mount bars (part #1034), as shown in Photos 8/107 and 8/108.

REPLACING ENGINE MOUNT BARS

Make sure that each engine mount bar—after being cleaned and greased—has been placed in the engine mount with the threaded hole or red plastic cap on top.

When holes in the engine mount and the transmission are lined up, insert the engine mount bar and push it down on one side—see Photo 8/108. Then, insert the bar on the other side of the engine mount so that it holds the engine and mount in place for you temporarily.

Next, screw the holding bolt and the jam nut for each mounting bar partially into position. Don't let the bolt protrude into the hole far enough to prevent passage of the engine mount bar.

Tap the bars down lightly until they have penetrated the lowest hole of the transmission case—see Photo 8/109. Align the engine mount assembly as you do so. Momentarily, leave the bars right where they are. Then, screw in the locking bolt until the bar offers the slightest resistance. Using a wrench to maintain slight pressure on the bolt, while you continue to tap the bars in place, wait for the groove in the bar to reach the bolt—see Photo 8/110.

Pressure will be released from the bolt. Hold the bar in that position. Screw the bolt all the way in finger-tight, then back off one-half turn. Lock the bolt securely in place with jam nut using two wrenches—one to hold the bolt in position and the other to lock the jam nut. Test

the up and down play of the mounting bars by lifting up on the bar and pushing it back down. This test is only valid if someone supports the engine and aligns the holes, while you test the bars. Repeat the same process on the other side of the engine.

As you can see, the engine mounting bars need to be lubricated well so that the engine can be raised and lowered on the bars as you shift the Forward/Reverse Lever.

Next, reinstall the bolts that mount the yoke to the engine mount (part #1002)—see Photo 8/98. (Make sure the bushings are in the mounting holes of the yoke.)

REINSTALLING THE MATCHED SET OF BELTS

Now, it is time to reinstall a matched set of belts (part #1128) on your tiller. Please refer to the belt removal and installation instructions in Section 7 of this manual for illustrations and directions. Remember to do this before you reinstall the reverse disc and while you are installing the belts. Also, remember to keep the belts inside of the belt guide on the motor mount. After the belts are installed, then return to the next step.

REPLACING THE REVERSE DISC

Before installing the disc, look at it to make sure the surfaces are not chipped or gouged out. Note whether there is excessive wear on



(Photo 8/107) Line up holes, put in bar.

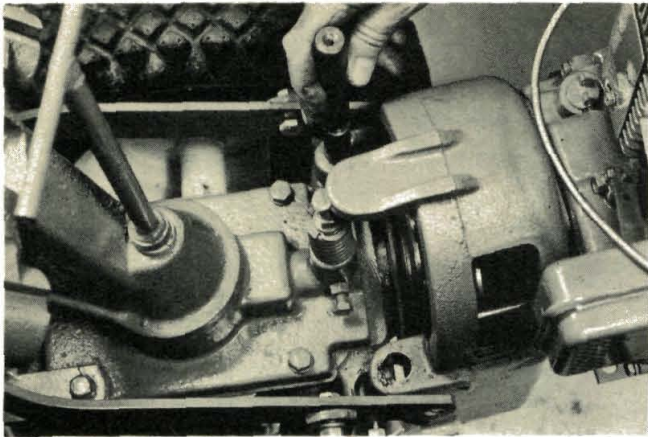

(Photo 8/108) Start bar in one side.

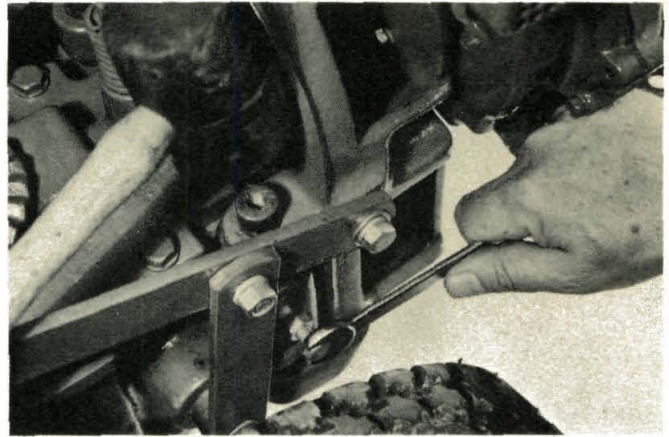

(Photo 8/110) Hold pressure on bolt and tap.



(Photo 8/109) Tap bars in place.

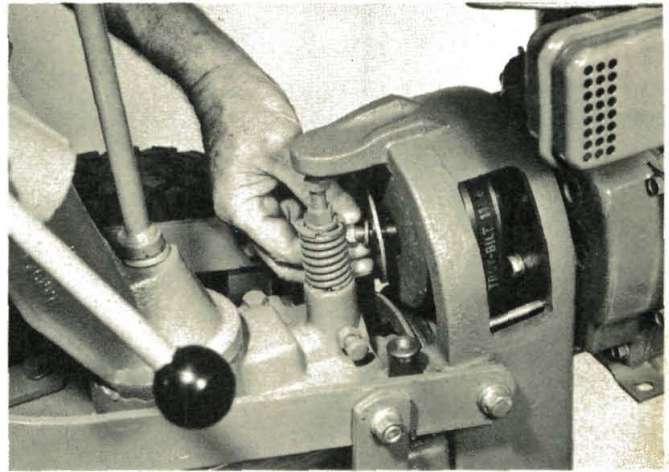

(Photo 8/111) Install bolt, washer, plate and Reverse disc.

8

the bottom edge of one surface. (Excessive wear could mean misalignment of the upper and lower pulleys.) Now, put the reverse disc back on the engine pulley, followed by the disc mounting plate and bolt—see Photo 8/111. Tighten the reverse disc mounting bolt securely.

Now, with the reverse disc reinstalled, stand up along the right-hand side of the tiller while someone shifts the lever into and out of Reverse for you—or you can reach over with your left hand and shift the lever into Reverse and release it several times. Closely watch the reverse disc as it lowers toward the transmission pulley. Make sure that it is aligned properly, so that the disc lowers into the groove of the lower pulley. Also, make sure that the reverse disc is well centered over that groove in the lower pulley.

HOOK UP THE THROTTLE CABLE & CHECK THE CLUTCH CONTROL

Replace the throttle wire on the engine speed control assembly, taking care not to spoil the bend of the tip. Then, place the throttle cable in the holding clamp, but don't tighten the screw at this time. Move the throttle lever all the way to the right and then tighten the screw on the clamp. Please refer to the throttle cable and reverse disc instructions in Section 7 for information on making final adjustments to these important controls. Check the belt tension and action of the Forward/Reverse Lever in all positions.

After all bolts have been fastened and adjustments have been made, make sure that you have the proper amount of #30 SE motor oil in the engine. Make sure that the engine pulley mounting bolt is tight and that you have clean, fresh regular gasoline in your engine. When all this is done, you are ready to begin tilling again.

REMOVING TILLER TRANSMISSION

from HORSE MODEL TROY-BILT TILLER

OWNERS OF ELECTRIC START TILLERS
...Please refer to Part 8 on page 159 and then
return to Part 1, Step 1 after the battery
and its bracket have been disconnected as
indicated.

PART ONE

REMOVE THE HANDLEBAR ASSEMBLY

Step 1. To disconnect the throttle wire from the carburetor and speed control assembly, loosen the cable retaining clip and lift the throttle wire out of the clip. See Photo 8/112.

Step 2. Remove the "T" bar handlebar mounting clamp and remove the handlebars. As you place them aside, be careful that the throttle cable does not get bent or kinked.

Step 3. With the "T" bar clamp out, place a flat pan with 2" high sides, or a shallow plastic pail or bucket underneath the tiller transmission drain plug. It's the lower plug on the left side of the tiller, shown in the photo. Drain the tiller transmission oil. See Photo 8/113.

Step 4. Remove the mounting bolt, plate and the reverse disc—see Photo 8/114.

PART TWO

REMOVE FORWARD/REVERSE LEVER & ENTIRE YOKE ASSEMBLY

Step 1. Remove the bolts that fasten the control yoke to the engine mount as shown (one on each side) in Photo 8/98 and at A in Photo 8/114.

Step 2. Remove the bolts that fasten the yoke control pivot link to the pinion bearing retaining plug on the transmission as shown. . .one on each side. See Photo 8/115.

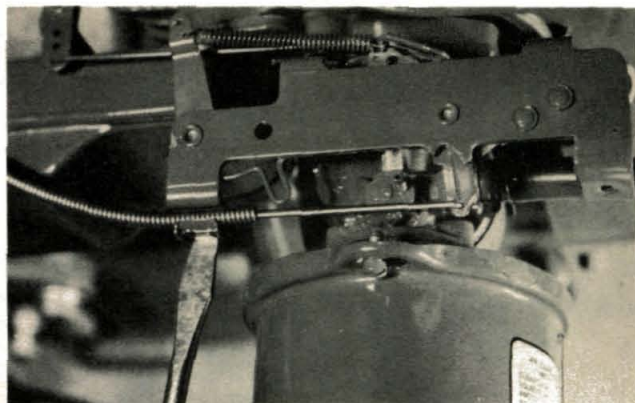

(Photo 8/112) Don't kink throttle wire.



(Photo 8/113) Drain gear oil.

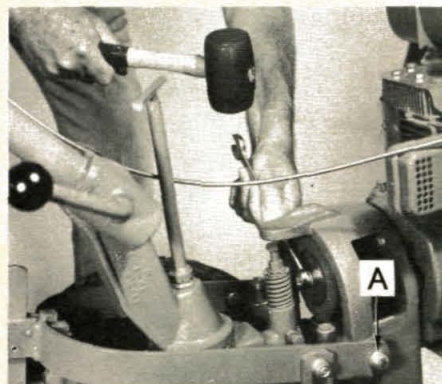

(Photo 8/114) Remove reverse disc.

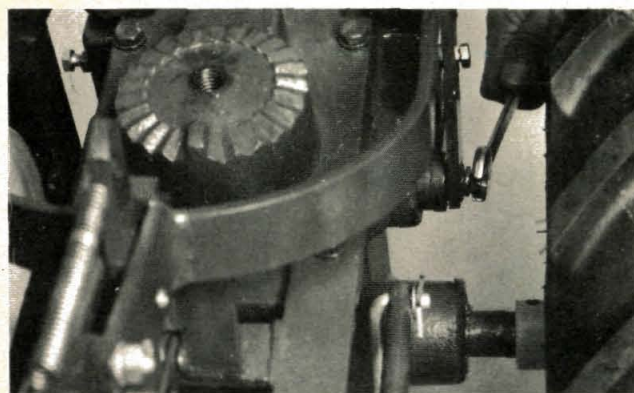

(Photo 8/115) Remove bolt in side plug.

Step 3. Lift the entire yoke and Forward/Reverse Lever off the tiller as a single assembly and place it carefully aside. See Photo 8/116.

PART THREE

REMOVE THE ENGINE

Step 1. Remove the bolts on each side of the engine mount that lock the engine mounting bars (part #1034) into position. Note that each has a bolt and a jam nut to hold the bar in position. See Photo 8/117.

Step 2. Use a screwdriver and a mallet, or a length of rod to drive the engine mount bars down and out the holes. Take care not to damage the threaded holes in the top of the bars which are used to mount the Dozer/Snow Blade. See Photo 8/118.

Step 3. Lift and remove the engine and engine mount assembly. Lift up the engine enough to clear the lower pulley (part #1008-1). When you lift up the engine, don't hold it by the carburetor or air cleaner. You can break the carburetor that way. Instead, pick up the engine by its steel base and the steel fuel tank mounting bracket. See Photo 8/119.

With the engine cleared $\frac{1}{2}$ -inch above the lower pulley, move the assembly away from the transmission, lowering it away to clear the belts from the upper pulley. **NOTE:** Belts can be removed, if necessary, by working them off the upper pulley with your fingers. Tilt the engine toward the operator position as you work with the belts.

PART FOUR

REMOVE TILLER DRIVE PULLEY

Step 1. To remove the lower pulley (part #1008-1), all you need to do is remove the snap ring (part #9500) in front of the pulley and slip the pulley off the drive shaft. See Photo 8/120.

The snap rings are best removed with external snap ring pliers. However, if pliers are not available, you can remove the front snap ring with a fine blade screwdriver by carefully running the blade of the screwdriver around the groove to unseat the snap ring.



(Photo 8/116) Lift yoke and lever.

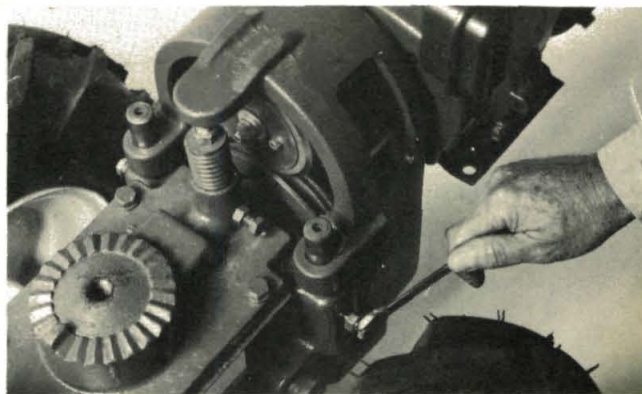

(Photo 8/117) Bolt for engine mount bar.

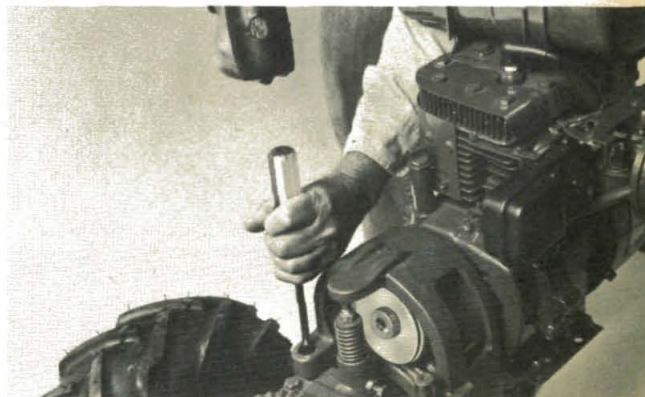

(Photo 8/118) Drive bar down and out.



(Photo 8/119) Put engine on box.

Removing the *rear snap ring* with the same method is more difficult because you have to try to spread the snap ring while you move it along the drive shaft.

If your tiller transmission is being removed for shipment back to the tiller factory, just leave the rear snap ring in place. Your new transmission will come with the rear snap ring installed to solve that problem for you.

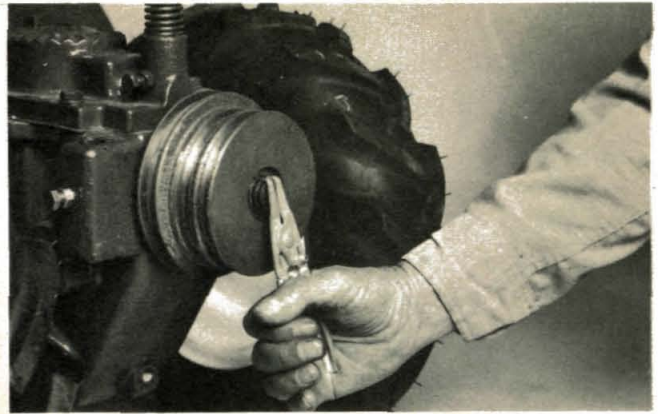

(Photo 8/120) Remove snap ring with pliers.

PART FIVE

REMOVE HOOD, WHEEL SHIFT LEVER & DEPTH REGULATOR AS A SINGLE ASSEMBLY

Step 1. Remove the bolt affixing the depth regulator's drag bar (part #4763) to the tab on the transmission. See Photo 8/121.

Step 2. Tilt the tiller upward and prop the tines up with a wooden block. Then, *remove the two bolts from the end cap* shown in the photo. Put the tiller back to its level position. See Photo 8/122.

Step 3. Remove the bolt *on each side* that fastens the front hood bracket to the transmission, as shown in Photo 8/123.

Step 4. Remove the nut connecting the swivel in the wheel shift linkage to the small lever underneath the rear of the tiller transmission. Place the nut on the swivel for safe keeping. See Photo 8/124.

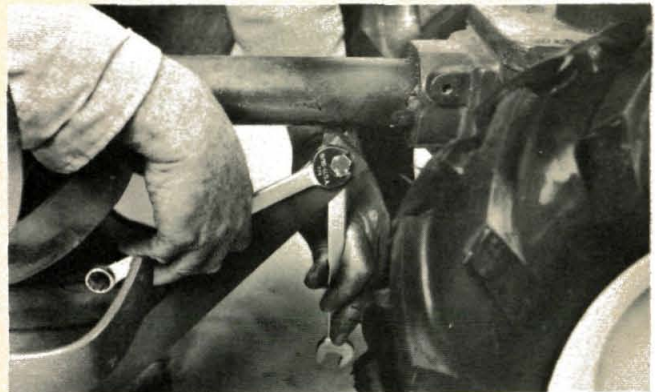

(Photo 8/121) Disconnect drag bar.



(Photo 8/122) Remove bracket bolts from end cap.



(Photo 8/123) Side bolt on bracket.

Step 5. Remove the two bolts on top holding the front hood bracket fast to the transmission—see Photo 8/125.

Step 6. Lift up the hood, brackets, shift lever and depth regulator as one single assembly. Move the assembly back to pull the drag bar out between the tires. Then, place the assembly aside. See Photo 8/126.

PART SIX

REMOVE TINES AND HOLDERS

Step 1. Remove the nut and washers on the end of each tine stud.

Step 2. Using a mallet, strike the tines outward to free the tine holder from the keys in the shaft. Remove the complete tine holder assembly and tines as a unit. Be careful not to lose the keys. If they do not come out of the keyways easily, use pliers or cutting pliers to lift them out. If the key remains in the tine holder, tap it out with a screwdriver, as shown in Photo 8/127. Use gripping (locking) pliers to remove each tine stud from the tiller shaft—see Photo 8/128.



(Photo 8/124) Nut on swivel.

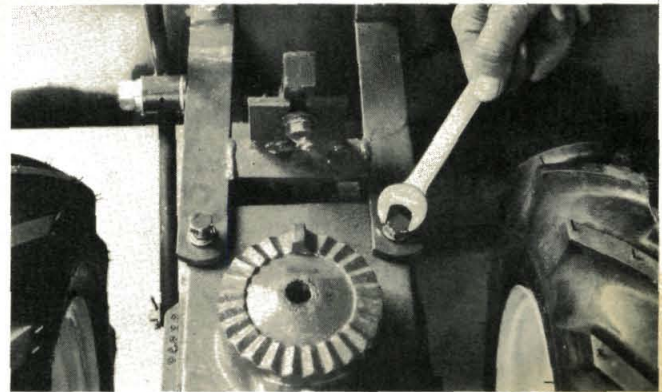

(Photo 8/125) Bracket bolts to cover.

8

PART SEVEN

REMOVE WHEELS

Step 1. Place something such as boards or a block, or the nailed block (mentioned on page 123, "Replacing Wheels"—see Photo 8/1) under the tiller transmission to get the wheels off the floor, as shown in the photo.

Step 2. Use a long thin punch, a rod, or a 16d nail with a flattened or rounded point to drive the roll pin down through the wheel hub, as shown in Photo 8/129.

Step 3. Pull the wheel off of the shaft and repeat the process for the other wheel.

Please see Photo 8/2, at the beginning of Section 8.



(Photo 8/126) Hood, lever & regulator come off.

BrentChalmers.com

Squirt some penetrating fluid, then oil on the wheel shaft if you have trouble removing the wheel from the shaft because of rust.

When the tines and wheels are removed from the transmission, your task is completed. If you are preparing the transmission for shipment back to the tiller factory for service, please see the instructions entitled, "Preparing a Tiller Transmission for Shipment," found later in Section 8, for preparation of a crate for shipping your transmission back to the factory. See Photo 8/130.

In moving your transmission, you can thread the "T" bar clamp for the handlebar mount in its proper hole securely. The "T" bar will support the entire weight of the tiller, wheels, engine and all, so it will easily hold the transmission alone. Later, put a plastic, rubber or cork plug in the transmission oil fill hole to keep any residue oil in or dirt out during shipment.

PART EIGHT

FOR ELECTRIC START ENGINES— FIRST STEP IN TRANSMISSION REMOVAL

Step 1. Remove the bolt and nut on top and remove the cable from the positive terminal of the battery.

Remove the nut at the bottom of the long bolt clamping down the battery on the negative side. Remove the bolt on the negative side and loosen the similar bolt on the positive side, and swing the hold-down clamp out of the way—see Photo 8/131.

Step 2. Remove the battery and place it aside in a safe place, also see Photo 8/131.

Step 3. Disconnect the terminal from the bottom of the key switch (A in Photo 8/131).

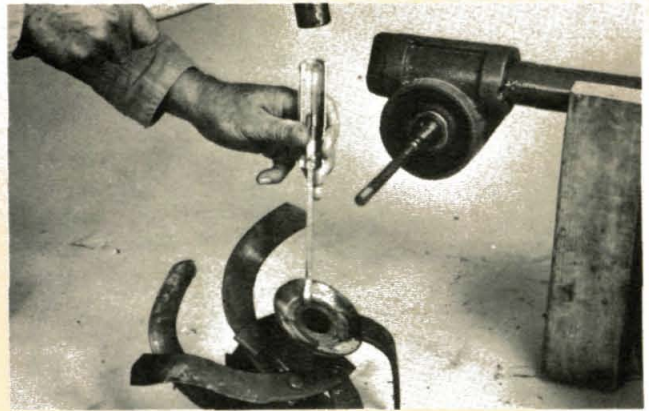

(Photo 8/127) Knock out key.



(Photo 8/128) Remove tine stud, watch threads.



(Photo 8/129) Roll pin holds wheel on.

Step 4. Disconnect the battery recharging line (B in Photo 8/131), also shown in Photo 8/132.

Step 5. Disconnect the cable leading from the left side of the solenoid (as you stand in front of it) to the starter motor. This is the cable leading from the starter motor at the engine back to the solenoid. Replace the nut on the starter motor post so that it doesn't get lost (see Photo 8/133).

Step 6. Remove the two bolts fastening the battery bracket to the tiller transmission. The entire battery assembly will lift off while it is intact. Replace the bolts in the transmission cover. See Photos 8/134 and 8/135.

PREPARING A TILLER TRANSMISSION FOR SHIPMENT

By using fir, pine or scrap lumber, you can construct a shipping case for shipment of your tiller transmission in the method illustrated by the photos. The 2 x 4 blocks supporting the wheel axle are cut out, notched, or plowed out to create a cradle for the wheel shaft (Photo 8/136).

Instead of the metal strapping, some owners have used strong wire to hold the transmission fast to the skid. The plywood cover is nailed with box nails into the skid.

Before you cover the transmission, please put a cork, a dowel, or another piece of wood wrapped in cloth, or a large plastic plug, into the hole at the top of the transmission cover. One can't rely on the fact that you print "This Side Up" on the crate. During shipment, the crate is likely to be put up on end at least. If all the oil has not been drained out, it will leak out that hole if it is not plugged in some way.

For those who are receiving a replacement transmission: Many people wait until the new transmission arrives and use that crate for returning the old one. See Photo 8/137.



(Photo 8/130) This is the way your transmission should look when you complete dismantling.

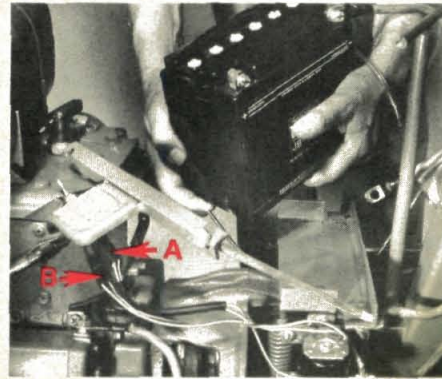

(Photo 8/131) Remove battery.

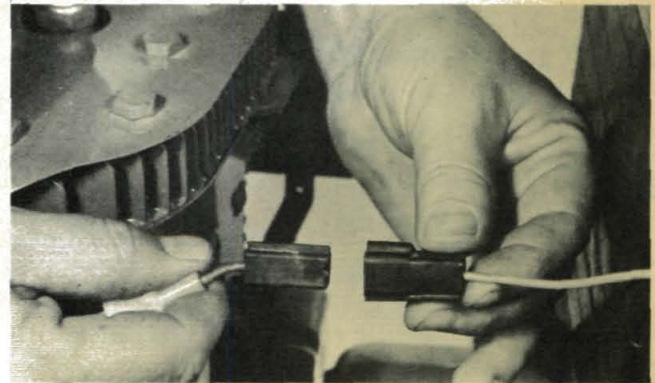

(Photo 8/132) Disconnect recharging line.

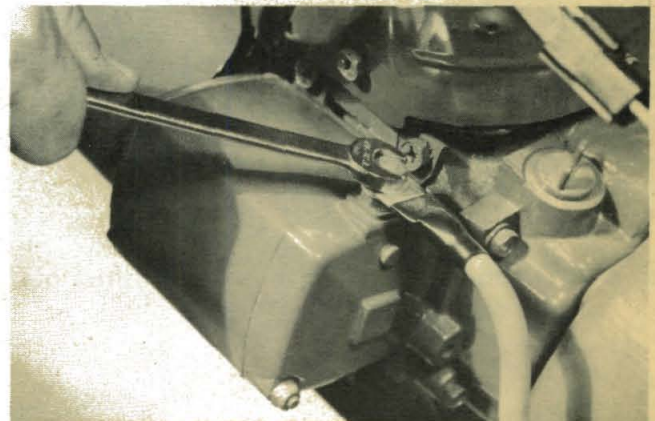

(Photo 8/133) Remove starter cable.

TO INSTALL A NEW, REPAIRED, OR REBUILT TRANSMISSION

FOLLOW THESE STEPS:

PART ONE



(Photo 8/134) *Unbolt battery bracket.*

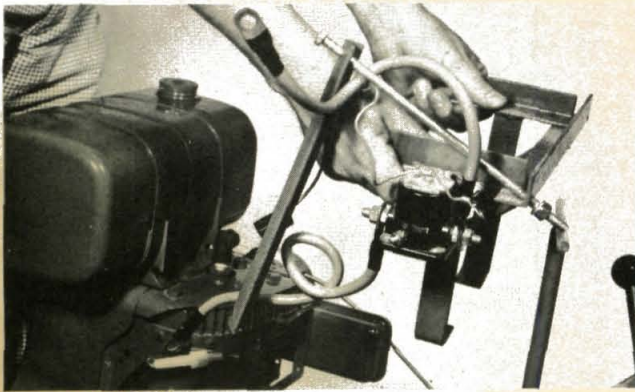

(Photo 8/135) *Remove solenoid with bracket.*

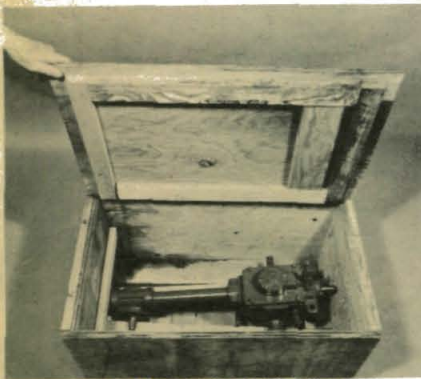

(Photo 8/136) *Shipping case.*

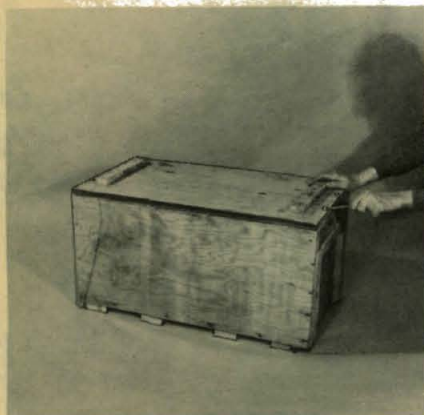

(Photo 8/137) *Top screws on.*

ADD GEAR OIL TO TILLER & INSTALL BOLO TINES

Step 1. After uncrating and unstrapping your transmission, if it's new or repaired, make sure that you add gear oil (SAE #90 or #140) through the hole in the top cover. While the transmission is on a level floor, fill the gear oil up to the point where it just begins to run out of the oil level hole 3 inches above the left wheel (remove pipe plug). Don't overfill. This angle is slightly steeper than normal and you'll tend to get a little more anyway. But too much gear oil could cause oil leaks later.

Step 2. Put a little grease or other lubricant on the threads of each tine stud. Make sure that the threaded holes in the end of each side of the tiller shaft are clean and free from dirt and grit.

Put the threaded end of the tine stud in the tiller shaft and tighten it with pliers, holding it in the center, unthreaded portion. Lightly file off any nicks on the keyway of the tiller shaft and tap the key in place before you install a Bolo tine holder. Bolo tines rotate in the same direction as the wheels and their cutting edges strike the ground first, like a knife. Install both Bolo tine assemblies, or other tines if you are using them. See Photo 8/138.

PART TWO

REPLACE WHEELS

Step 1. Put a block under the tiller transmission, grease the wheel shaft slightly—just where the

wheel hub rides. Slide the wheel in place and align the hole in the hub—which belongs inside toward the tiller—and the hole in the wheel shaft.

Replace a wheel pin and tap it into place with a hammer and the 16d nail or a thin rod. Take care not to peen the top of the pin over so that it can't be driven through the hole to remove again. See Photo 8/139.

PART THREE

REPLACE HOOD, WHEEL SHIFT LEVER & DEPTH REGULATOR AS A SINGLE ASSEMBLY, REVERSING ITS REMOVAL PROCEDURE

Step 1. Hold up the hood and slide the depth drag bar under the tines and the tiller until the front hood bracket can be aligned over the transmission bolts—see Photo 8/140. Remove two bolts from the transmission cover and attach the hood bracket with one bolt loosely—see Photo 8/141. Also, attach the side bolts for the hood bracket, shown in Photo 8/123.

Step 2. Attach the drag bar to the tab under the tube of the tiller transmission—see Photo 8/142.

Step 3. Prop up the tine assemblies with a wooden block and install the two bolts that fasten the depth regulator assembly to the end cap on the transmission. Now, install and tighten the front hood bolts described in Step 1. See Photo 8/143.

Step 4. Reconnect the connecting rod swivel to the eccentric lever, as shown in the photo. Do so by removing the 5/16"-18 lock nut from the swivel. Run the swivel through the eccentric lever and replace the lock nut—see Photo 8/144.



(Photo 8/138) Remove nicks and install tines.

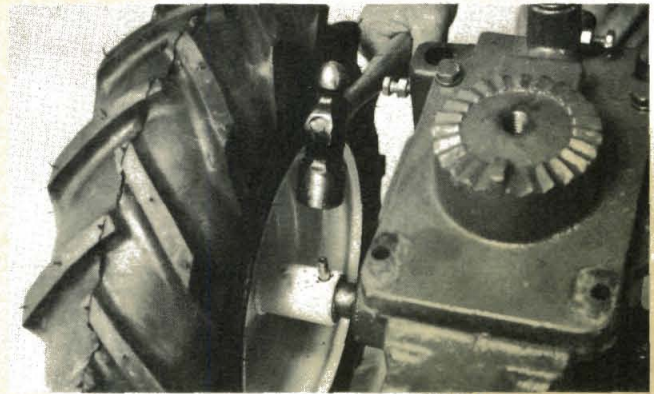

(Photo 8/139) Put roll pin back in wheel.



(Photo 8/140) Replace hood, lever and regulator

PART FOUR

REPLACE TRANSMISSION DRIVE PULLEY

Step 1. Make sure that the drive shaft is clean and free from burrs, and has some light grease between the snap ring grooves. See that the key is squarely and firmly in the keyway. See Photo 8/145. Then slip the lower pulley on the shaft. Take snap ring pliers and install a new snap ring (part #9500) in front of the pulley. Naturally, the snap ring has to be installed between the pulley and the transmission before you do this. But, the snap ring closest to the transmission will have been installed before you received a new or rebuilt transmission. If not, make sure there is one so that the retaining rings limit the travel of the lower pulley. See Photo 8/120.

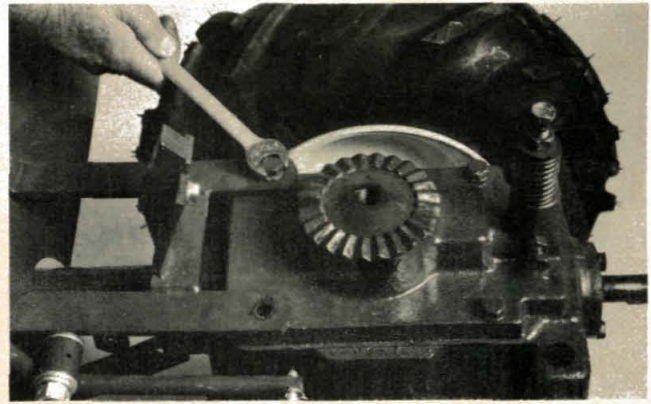

(Photo 8/141) Attach loosely, at first.

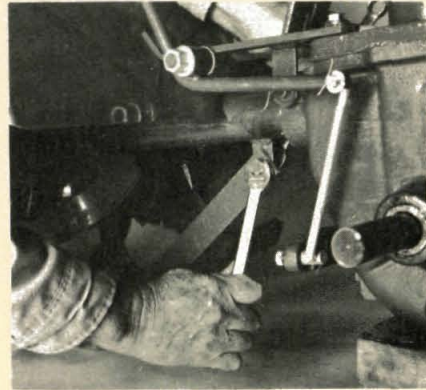

(Photo 8/142) Attach drag bar.

PART FIVE

INSTALL THE ENGINE

Step 1. Install the engine without belts mounted and without the reverse disc installed. Make sure that the engine mount bars (part #1034) are clean and lightly greased. When installing, make sure the threaded holes in the bars are on top (they are for the Dozer Blade bracket).

Lift up the engine by holding the left hand under the base and the right grasping the fuel tank bracket.

CAUTION: DON'T LIFT THE ENGINE BY GRASPING THE AIR CLEANER OR CARBURETOR. This will break the carburetor. Place the engine and motor mount over the front of the transmission so that the holes are aligned. Then, push one engine mount bar down part way, then the other—see Photo 8/146.

Step 2. Loosen the bolts on each side of the transmission that lock the mount bars. Back them off to clear the hole for the bars to go through.

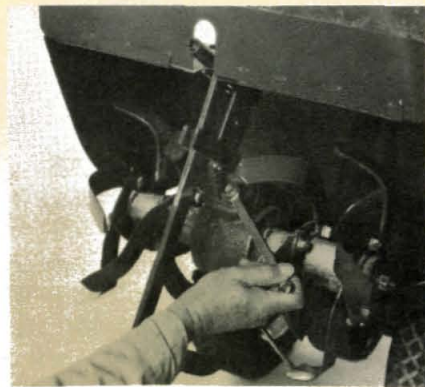

(Photo 8/143) Bolt to end cap.

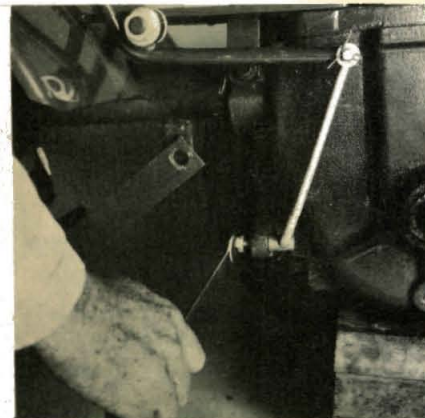

(Photo 8/144) Swivel on eccentric.

Tap the bars down through all holes with a hammer and a screwdriver or thin bar. Before the bar goes all the way through the bottom hole, thread in the locking bolt until you can feel pressure against the mounting bar. Hold pressure on the bar with a wrench and continue to tap the bar down until the pressure releases. Then, you know that you have reached the groove in the bar. See Photo 8/147. Screw the bolt all the way in without forcing. When it reaches the bar, back off $\frac{1}{2}$ turn and hold the bolt in place with one wrench while you tighten the jam nut with another wrench.

Repeat the process with the bar on the other side.

Step 3. Install the belts after referring to "Belt Changing" in Section 7 of this manual.

Step 4. Install the reverse disc with the mounting bolt, lockwasher and plate.

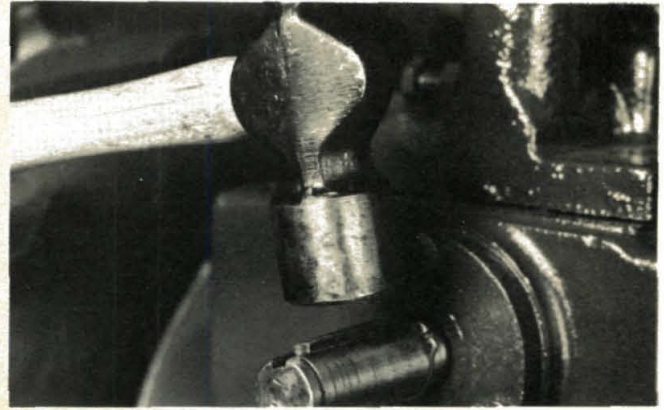

(Photo 8/145) Put key & snap ring on, then pulley.



(Photo 8/146) Line up holes, insert bar.



(Photo 8/147) Hold pressure on bolt and tap.

PART SIX

INSTALL FORWARD/REVERSE LEVER & YOKE ASSEMBLY

Step 1. Remove one bolt from the base of the Forward/Reverse Lever and tilt the lever upward. Remove the clutch pawl spring (part #1122) from one hole only. This will take tension off of the clutch roller when you are installing it—see Photo 8/148.

Step 2. Move the yoke into position to attach the bolts on each side of the engine mount and those that fasten the linkage to the retaining plugs on the lower side. *Make sure that the bushings are inside the links before you fasten the bolts.* See Photo 8/149. If you have trouble aligning the bolt and the hole, remove the bolt, washer and spacer. Put them on the bolt in proper order and then thread the bolt into the hole in the motor mount. Tightening the bolt will push the spacer into place.

Step 3. Reconnect the spring on the Forward/Reverse Lever and align the holes so that you can replace the bolt you removed from the lever. Make sure that both bolts are fastened tightly enough to close up the lock washers. See photo 8/150.

Try shifting into Forward, then Neutral and Reverse. The lever should hold properly in Forward and should release quickly from Reverse when you let the lever go. Check belt tension and correct it, if there is not a deflection of about ¼" in Forward position. Check reverse disc alignment with the lower pulley and check reverse action later when you run the engine.

Special Note for Electric Start Tillers—Reverse the procedures of Part Eight, pages 159 & 160, and follow Steps 6, 5, 4, 3, 2 & 1.

PART SEVEN

REPLACE THE HANDLE BAR ASSEMBLY & THE THROTTLE CABLE

Step 1. Mount the handlebar assembly back on the tiller with the "T" bar clamp.

Step 2. Reconnect the throttle cable near the carburetor (to the remote speed control lever). Check the throttle action for full power, idle and engine shutoff.

CAUTION: Make sure the oil level in the engine is up to the full mark. And, recheck the tiller gear oil to make sure it flows when the plug is removed from the oil level hole.

You're now ready to test the engine and to test the tiller controls.



(Photo 8/148) Rehook lever and spring.

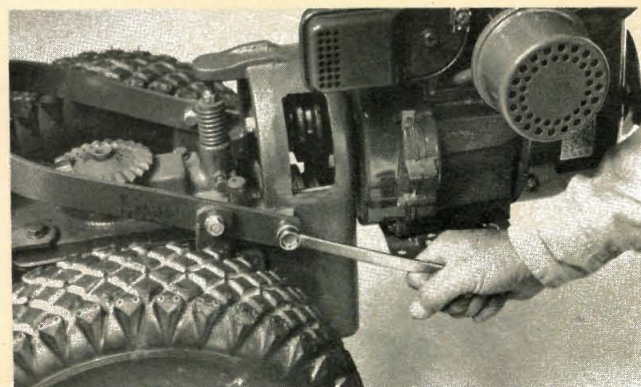

(Photo 8/149) Bolt yoke to motor mount.



(Photo 8/150) Tighten bolts on lever.

TROUBLESHOOTING & SPECIFICATIONS

OWNERS PLEASE NOTE: In the following portion of this manual on “Troubleshooting,” please refer to the HORSE MODEL MASTER PARTS CATALOG for location and identification of tiller parts named in the solution to specific problems. You should have received the MASTER PARTS CATALOG along with this OWNER’S MANUAL when your tiller was delivered. The page numbers given below pertain to those in the OWNER’S MANUAL.

TROUBLESHOOTING: TILLER

PROBLEM

WHAT TO DO & REFERENCE

1. Forward/Reverse Lever:

Jumps Out of “Gear”

- Belts may be too tight—raise belt adjusting block a little, see page 102.

Hard To Get Into Reverse

- Clutch spring, part #1122, might be over-stretched, replace if needed—see page 102.
- Check reverse disc for excessive wear, part #1072. Replace disc if badly worn or chipped—see pages 104 105 and 106.
- Check adjustment of reverse spring and plunger, part #1036 and #1035, see page 102.
- Grease motor mount bars, part #1034, and belt adjustment block, part # 1133. Oil linkages for Forward/Reverse Lever.
- Make sure lower pulley is oiled and slides back and forth on drive shaft freely.
- Forward/Reverse lever may be hitting handlebars.
- Adjust reverse adjustment bolt, see page 102
- Grease motor mount bars, and #1133 block. Oil Forward/Reverse Lever linkages.

Reverse Very Noisy

- Check for chipped or worn reverse disc.
- Check disc alignment. See page 103 about adjustment.

Reverse Remains Engaged When Lever Is Released

- Adjust reverse adjustment bolt, see page 102.
- Grease motor mount bars and oil clutch lever linkages.

Locks In Forward Position

- Make sure you have grease on #1133 block and the #1034 mount bars.
- Check position that the clutch roller takes on adjustment block—see page 122. If roller locks under the bottom edge of block in Forward, you may have to bend the mounting bracket for the #1133 adjustment block a fraction of an inch toward the engine. See page 122, Photos 7/65 & 7/66 and Sketch 7/67 for method of adjusting angle of bracket.

2. Wheel Speed Shift Lever

Drops Out of High Speed

Hard To Shift Wheel Speeds

Very Hard To Shift or Stuck in High or Low Gear

Lever Can't Shift Into Low, But Will Go Into High Gear

Lever Will Shift Into High or Low Gear, But Won't Stay Engaged

Can't Shift Out of High or Low Gear—Tiller Runs at Only One Speed

Moves Freely Back and Forth but Can't Move Tiller Under Power At All

3. Tiller Starts Into Motion By Itself

(tines out of ground)

4. Shift Forward/Reverse Lever into Forward or Reverse, Tines or Wheels won't Turn

- Tighten locknut, part #9806, on pivot point of lever.
- Loosen locknut on pivot point of Wheel Speed Shift Lever, see page 92. Oil shift lever linkage and hole in pivot point.
- Check for rust on eccentric shaft (external portion). Oil and work back and forth by hand.
- Possible binding clutch (spool), part #1237. Disconnect speed shift linkage; work eccentric lever by hand. If problem continues it might be necessary to replace the wheel shaft. The shaft could be swollen around the key—preventing you from shifting.
- Oil shift lever linkage and hole in pivot point. (See Photo 7/2).
- Connecting rod, part #1231, at bottom of Wheel Speed Shift linkage might be backwards, or bent in toward transmission and hitting it. Other linkage might be bent inward. Straighten out.
- Eccentric drive pin may be broken or worn (on well-used tillers). Replace pin. (Contact Customer Service Representative for instructions.)
- Oil Shift lever linkage and hole in pivot point. (See Photo 7/2).
- Possible broken eccentric drive pin inside transmission. Remove tiller top cover, drain ½ gear oil out, look for drive pin on clutch. If it is missing, replacement is necessary. Please send for installation instructions.
- Possible broken eccentric inside transmission. If this is the case, replace it.
- Possible broken eccentric shaft inside transmission. Disconnect eccentric lever from shift linkage and try moving by hand. Easily moving eccentric lever, without rolling tiller a few inches to lock lugs in gear, indicates probable broken eccentric. Send for eccentric replacement instructions.
- Make sure lever is not too loose. Check locknut for tightness. See page 92.
- Possible broken eccentric drive pin. Replace shoe. Send for installation instructions.
- On very new tillers, give them 1 hour of operation to break-in. Problem should disappear.
- Adjust belt tension by raising #1133 belt adjustment block up a little to loosen belt tension slightly.
- Check operation of tiller control, Section 2.
- Possible missing key, part #9303, in engine pulley, part #1007-1, or key, part #9302, on transmission drive pulley, part #1008-1. See page 106 to remove engine pulley and page 132 to remove lower pulley.

PROBLEM

**5. Tines Will Turn,
But Wheels Won't Turn
(Speed Shift Lever Goes
Into Either Gear)**

6. Wheels Turn, But Tines Won't

**7. Wheels and Tines Turn on Top
of Ground, But Stop or Hesitate
in Soil.**

9

8. Tiller Jumps during Tilling

**9. Engine Runs Well with no Load,
But Labors when Tilling**

**10. Depth Regulator Hard
To Move Up or Down**

**11. Can't Turn Lever
To Lower Handlebar**

**12. Wheel and Axle Move Out
To One Side.**

WHAT TO DO & REFERENCE

- (For assembled drive shaft only.) Key, part #9301, possible missing from front worm, part #1220. Remove top transmission cover and check front worm. If you can turn worm alone by hand key is missing.
- (For welded and assembled drive shafts)—possible Hi-Pro key, part #9305, out of wheel shaft. Drain $\frac{1}{2}$ gear oil out to make the check. Remove top cover from transmission and spin the #1237 clutch spool. If it spins freely, the key is missing. Request wheel shaft removal instructions and install a new #9305 Hi-Pro key.
- Possible missing keys at either rear worm, part #1063 (assembled shaft only), bronze tiller worm gear, or tiller shaft (part #1026). Before proceeding further, tilt the tiller up on its engine, and put the Forward/Reverse Lever in Forward and the Wheel Speed Shift Lever either in High or Low. Try to rotate tines by hand. A key is missing if you can rotate them
 - To check keys on tiller shaft, remove tines and look for missing keys.
 - To check an assembled shaft for a missing rear worm key, remove the side cover and rotate the tiller shaft with a hand on each side of the shaft. If the gear and worm turn, but the transmission pulley does not, then worm key, part #9301, is missing (all controls in Neutral).
 - To check for missing key in bronze tiller worm gear, the tiller shaft assembly will have to be removed from the tiller housing. See "tiller shaft removal" in Section 8.
- Possible missing key in lower pulley, part #1008-1. (Front end quite noisy, belts might overheat).
- Belts possibly loose and needs adjusting. (Noise not a factor.)
- Depth Regulator set too deep for soil conditions.
- Throttle speed too high.
- Shift to low wheel speed.
- Possible worn bronze worm gear, part #1064, and loose drive shaft and bearing (on well used tiller).
 - Tilling depth possibly too deep, lower adjustment bar.
 - Check engine governor linkage for freedom of movement.
 - Check throttle setting and carburetor adjustment.
- Lubricate its spring and plunger and depth adjustment bar.
- Check for bent depth adjustment bar.
- Loosen stud and lubricate stud threads and nut. Check both for stripped threads.
- Snap ring is out of its groove in wheel shaft, part #1235. Check for play in axle. Wheel bushing should be flush with casting. Shim bushing to remove play before replacing snap ring. Leave very little play in shaft. Shim and replace oil seal.

PROBLEM

WHAT TO DO & REFERENCE

13. After Replacing Bolo Tines, Tine Stud Breaks or Holders Loosen

- Make sure that keys are in the **keyways**. Without key in holder, left tine stud will tighten and break. Right holder will loosen.

14. Cultivating Tines Break With First Use

- It might be that inside tine holders on left and right side were put on wrong side. Cutting edge of tine must face forward and strike the ground first. Tip follows edge into ground. See page 143.

15. Tines Rattle

- Even though bolts are tight, tines may rattle and make noise. This is due to shrinkage of casting of holder. No correction is necessary. Just make sure that tines don't hit transmission tube or hood. Sometimes an extra washer under tine clip will quiet it down.

16. After Belt Adjustment Block Is Replaced, Forward/Neutral/Reverse Lever Locks In Forward

- Check to make sure that block was not installed upside down or backwards. Indentation on #1133 adjustment block should be at bottom of block as it is installed.

17. Tiller Pulls to Right or Left

- Equalize tire pressure.

18. Traction is Poor While Tilling, Using Dozer/Snow Blade or Furrower

- Use tire chains or Bar Tread tires.

19. Oil Leaks

From Wheel Axle

- Give seals time to lap in.
- Replace worn or damaged seals.

From Left Side of Tiller Housing

- Check for loose cover. Make sure screw threads have Permatex on them. Replace seal if bad; see page 127.

From Right Side of Tiller Housing

- Replace seal if bad; see page 127.

From End Cap

- Remove hood bracket and check end cap screws to make sure there is sealant on threads. If end cap screws were tight, remove cap (replace gasket) and check main drive shaft end play—see page 129. Shim drive shaft. Permatex threads of screws.

From Handlebar Base or Bottom Of Reverse Spring & Plunger

- Check oil level to be sure it is not overfull. These spots act as oil relief points. No further action necessary.

Under Front of Tiller Transmission

- Check to make sure engine oil isn't dripping from air cleaner or engine base and traveling along yoke to tiller transmission. Make sure oil doesn't come from reverse spring and plunger and run down front of transmission. (Look for it in bottom of engine mount, part #1002.)
- Check seal in front tiller cap and gasket, part #1124.
- Check engine seal on Power Take Off (PTO) shaft.
- **NOTE:** Oil can't leak from threaded hole at bottom of transmission with plastic cap in it. That hole doesn't go through transmission case. It is for mounting of lower part of Dozer/Snow Blade attachment bracket.

PROBLEM

WHAT TO DO & REFERENCE

19. Oil Leaks (continued)

At Back of Tiller Transmission Case

- Check “O” rings at eccentric shaft, part #1027.

From One of Three Pipe Plugs
In Transmission Case

- Tighten plugs; make sure the threads are coated with Permatex.

Between Transmission Cover and Case

- Tighten cover bolts.
- Replace cover gaskets if leaking.

20. Hard to Shift Forward/Neutral/ Reverse Lever Into Forward

- Check motor mount bars for lubrication. Check for bent bar, binding in hole. Lubricate belt adjustment block, the clutch roller and linkage.

TROUBLESHOOTING: ENGINE

PROBLEM

WHAT TO DO & REFERENCE

1. Engine Lacks Power

- Adjust power adjustment screw, see page 114, Section 7.
- Dirt or water in fuel or fuel system.
- Low engine compression. (See Low Engine Compression below.)
- Power adjustment screw might not have been correct for your altitude—it could cause a loss of up to 2 horse power if not properly adjusted.
- Tecumseh 6 H.P.—make sure engine isn't running with choke partially engaged.
- All engines—throttle cable clamp on engine could be loose, or maladjusted. See page 107, Section 7.
- Spark plug—dirty, or wet with oil.
- Engine crankcase low in oil.
- Engine crankcase has too much oil.
- Crankcase breather oil—return hole clogged.
- Engine overheating—check oil level, clean cooling fins, check fly wheel (blower). Oil may be dirty. Allow hot engine to cool down before restarting.
- Engine under excessive work load.

2. Engine Hard Starting

- Air cleaner restricted with dirt and/or oil.
- Spark plug worn or fouled (weak spark).
- Breaker points worn, pitted or improperly adjusted. See Service Dealer (for engines under warranty). Adjust or replace points.
- Dirt or water in fuel system.
- Fuel line restricted.
- Low engine compression—see Low Engine Compression below.
- Throttle cable and wire may not be properly adjusted. See page 107, Section 7.
- Choke not functioning—see page 42.

PROBLEM

WHAT TO DO & REFERENCE

3. Engine Won't Start

- Throttle wire and linkage binding, or bent and not free to move. See Photo 7/54.
- Remote throttle lever not free to move full distance.
- Tiller controls not in *NEUTRAL*.
- Fuel tank empty.
- Fuel line restricted or clogged, or valve turned off.
- Choke not functioning properly, see page 42.
- Water or dirt in fuel, and/or fuel system. Drain some fuel from bowl.
- Spark plug fouled or worn, see page 119.
- Carburetor power adjustment screw not set properly—see page 114.
- Air filter clogged with oil or dirt.
- Engine stop switch shorting out ignition system. For 6 H.P. Tecumseh, see page 119, Section 7.
- Faulty coil or condenser—check spark plug for bright spark, see page 119, Section 7.
- Breaker points out of adjustment, or pitted and worn. See service dealer for engines under warranty. External breaker assembly cover on Kohler can be removed to service points. Write to us for tune-up instructions for your engine.
- Electrical connections (6 H.P. Electric) loose or shorted against metal frames, brackets or covers.
- Battery discharged (6 H.P. Electric).
- Electric starter motor faulty (6 H.P. Electric).
- Carburetor float faulty (or float valve leaking—if so, tap side of bowl with handle of screwdriver). See engine serviceman if it doesn't stop.
- Stale fuel—won't vaporize properly, gums up carburetor float, channels and valves. Drain and add new fuel.
- Ignition timed incorrectly.

4. Engine Idles Too Fast

- Adjust idle speed set screw. See page 114, Section 7.
- Check throttle cable adjustment. See page 107, Section 7.
- Check all throttle linkage for freedom of motion.

5. Engine Won't Idle at All

- Check idle speed screw. See page 114, Section 7.
- Adjust idle speed adjustment needle while engine is at lowest throttle setting. See page 114, Section 7. (Recheck power adjustment screw setting after you achieve proper idling.)
- Open up idle adjustment needle (clockwise). See page 115, Section 7.
- Condenser may be defective or weak.

6. Engine Has Slow Recovery After Abruptly Moving Throttle From Idle To High Speed

- Cold engine, allow few minutes warm up time before moving tiller.
- Open vent hole in fuel cap with a fine wire.
- Fuel line blocked.

7. Engine Stalls Out (Without Load)

PROBLEM

WHAT TO DO & REFERENCE

7. Engine Stalls Out (Without Load) (continued)

- Carburetor—Power adjustment screw and/or idle adjustment needle—improperly set.
- Loose ignition system connections.
- Faulty condenser.
- Check with authorized engine service dealer.

8. Engine Overheats

- Clean engine cooling fins and engine shroud and covers.
- Check for fly wheel fins broken off (under engine shroud).
- Check oil level for too much or insufficient oil.
- Ignition timing improperly set.

9. Engine Blows Black Smoke

- Power adjustment screw set too rich. Lean out. See page 114, Section 7.

10. Low Compression

- Pull recoil starter rope a few inches until you feel resistance.
- Blown head gasket, or loose head bolts—check two bolts nearest muffler first.
- Valve stuck open, no real compression.
- Excessive piston ring wear.

11. Engine Backfires

- Mixture too lean, adjust carburetor power adjustment screw. See page 114, Section 7.
- Loose cylinder head, or head gasket leak.
- On 6HP engine ignition timing set improperly. Send for tuneup kit instructions.
- Loose carburetor or intake adapter plate.
- Possible weak or defective condenser.

12. Engine Runs Erratically

- Water or dirt in gasoline or carburetor.
- Carburetor adjustments not set properly.
- Spark plug fouled or dirty.
- Loose carburetor.
- Hole plugged up in fuel cap.
- Governor linkage not adjusted properly, or binding. Have serviceman check it.
- Governor not functioning properly.
- Condenser possibly weak or defective.

13. Engine Consumes Excessive Amounts of Oil

- Oil or dirt clogged crankcase breather assembly (indicated by oil dripping from air cleaner after engine shut-down). Clean drain holes in breather.
- Breather assembly put in upside down (drain holes must be on bottom).
- Piston rings worn, broken or not installed properly—allowing oil to pass (noted by blue or white smoke).
- Check pan gasket, engine seals and drain plugs for leaks.

14. Electric Starter Motor Won't Turn Engine Over

- Check battery charge. Start engine with recoil start and run for 1 hour, then recheck electric start.
- Check mounting bolts of starter motor for looseness.
- Have serviceman check starter motor pinion gear and spring, and starter pinion alignment with engine ring gear.
- Check battery terminals for corrosion.

PROBLEM

WHAT TO DO & REFERENCE

15. Engine Won't Recharge Battery

- Fuse on recharging line blown out.
- Battery won't take a charge.
- Diode might be defective.
- Battery recharging wire loose or broken.

16. Battery Gets Hot And/Or Foams

- Battery acid level low—refill with distilled water. See top of page 25 for minimum specific gravity of acid in battery.
- Battery acid level too high (foams).

17. Turn Key Switch And Nothing Happens

- Discharged battery. Check acid level and recharge battery.
- Short in Key Switch, or Key Switch wires. See page 117, Section 7.
- Defective solenoid. See pages 117 and 118, Photo 7/61.

18. Fuse on Rectifier Keeps Burning Out

- Bad starter or short in fields of armature.
- Look for loose wires, or wires touching metal.
- Short in fields of starter.
- Positive and negative battery cables reverse (fuse blows immediately).

19. Engine Runs Well, But Labors under Tiller Load

- Check for worn bronze tiller worm gear inside tiller housing and loose driveshaft and bearing.
- Check governor linkage for freedom of movement.
- Check throttle setting and carburetor adjustment.
- Tilling depth possibly too deep, lower adjustment bar.

Circle Your Engine Model & Specification Numbers Below

6 HP Tecumseh: HH60	Recoil start-105106F, or 105101F.
	Electric start-105107F, or 105103F.
7 HP Kohler: K161T	Recoil start, 281271 I, or 281181 J

Please see page 48 for assistance in locating your **engine model** and specification numbers. To locate your Troy-Bilt Horse Model **Tiller serial number**, see page 2.

HANDY TOOLS TO HAVE

- Two 9/16" Wrenches
- Two 1/2" Wrenches
- Two 7/16" Wrenches (at least one open end)
- One 3/8" Wrench
- One Rubber Mallet
- One Hammer
- One Screwdriver
- One Phillips Screwdriver
- One 3/16" Socket Head (Allen) Wrench
- One 5/32" Socket Head (Allen) Wrench
- One Pair of Pliers
- One Pair of Vise-Gripping Pliers
- One 1/4" Drift Pin
- One Ice Pick, Awl, or Cold Chisel (Oil seal removal)
- One Spark Plug Removal Socket (Wrench)
- One Snap Ring Pliers
- Oil Can
- Light General Purpose Grease

HORSE MODEL TROY-BILT TILLER SPECIFICATIONS:

HORSEPOWER: 6 H.P. Tecumseh-Lauson, Cast Iron Block Engine, with Recoil Starting. 6 H.P. Tecumseh-Lauson. Cast Iron Block Engine with 12-volt Battery Electric Starting (Automatic Recharging During Tiller Operation). 7 H.P. Kohler, Cast Iron Block Engine, Industrially Rated, with recoil starting and Automatic Compression Release.

SPEEDS: When the engine is operating at 3,000 RPM (revolutions per minute), the machine ground speed and tiller tine speed are:

	LOW GEAR	HIGH GEAR
Ground Speed:	.5 MPH (45 ft./min.)	1.2 MPH (104 ft./min.)
Tiller Tine Speed:	146 RPM	146 RPM

HEIGHT: Can be varied for easier loading into a station wagon or car trunk by turning down handlebars, having Forward/Neutral/Reverse Lever disconnected, depth regulator adjusted all the way up or down, and depth drag bar propped up to lower engine; range from 32" to any height suitable for operator. Without handlebars or Forward/Neutral/Reverse Lever — 32", in normal position (with tines off the ground).

LENGTH: 66" with handlebars. • 51" without handlebars.

WIDTH: 23" from hoodside to hoodside. • 20" tilling width.

WEIGHT: With 6 H.P. engine—268 lbs. • With 6 H.P. engine and battery electric starting system—294 lbs. • With 7 H.P. engine—286 lbs.

• For shipping weight, add weight of shipping container—original corrugated fiber box is 40 lbs., wooden crate is 80-90 lbs.

BEARINGS: Tapered roller bearings: main drive shaft, front and rear; tiller shaft. • Ball bearings: pinion shaft. • Bronze bushings: wheel shaft.

TRANSMISSION: Worm gear driven. **Bronze worm gears** that drive wheel shaft and tiller shaft are themselves driven by **steel worms**. Heavy duty spur gears provide final reduction to wheels.

• Entire power drive assembly operates in a bath of oil. Power is transmitted from engine pulley, by a pair of durable matched belts, to transmission pulley, thereby turning the main drive shaft — providing power to wheels and tiller tines. Instant selection of two forward and two reverse speeds is made from the operator's position.

• Wheel Speed Shift Lever and linkage is used to shift clutch into **LOW, FREE WHEELING, or HIGH**. Sliding clutch engages proper spur gear for selected wheel speed and turns wheel shaft.

• Transmission case and tiller housing are cast iron, connected by a threaded and spot welded steel tube. **One gear oil fill position** provides lubrication for entire transmission including tiller shaft assembly.

WHEELS: Single piece steel, 8-inch.

TIRES: 4:80 x 8", **tubeless**, standard tread tires with deep traction grip. • 4:80 x 8" **tubeless Bar Tread tires, optional** at extra cost. • Tire chains available for either tire type.

UNIFORM DEPTH CONTROL: **Eight-position** depth regulator for instant selection of tilling depth—even while in motion. "Travel" position clears tines 1 or 2 inches above lawns, driveways and floors.

HOOD: Heavy duty steel. **Completely encloses revolving tiller tines**, greatly aids pulverizing lumpy soil. Trailing hood flap contains churning soil from the rear, smooths out seed beds and protects operator's feet and legs. Hood width—23".

HANDLEBARS: Quickly adjustable Up & Down or Sideways without tools by loosening and resetting a lever for vertical movement, or a lever for horizontal adjustments.

• **Engine throttle control** mounted on right handlebar and **electric start push button** (if used) mounted **inside left handlebar grip**.

ENGINE SPECIFICATIONS:

A. 6 HP TECUMSEH-LAUSON

GENERAL DESCRIPTION: Four cycle, recoil start is standard; 12-volt battery electric key start, with automatic recharging during tiller operation, is optional.

MODEL: **HH 60-105106F (Recoil Start).**

• **HH 60-105107F (Electric Start)** • Precision cast iron alloy cylinder and crankcase. • Compression release included for easy starts.

CRANKSHAFT: Steel, with integral counterweights. Crankpin and both main bearing journals are induction hardened.

MAIN BEARINGS: Durable bronze bushing with large bearing surface supports Power Take Off (PTO) end of crankshaft, bronze bushing at other end.

LONG LIFE MATERIALS: Resists heat and wear. **Exhaust System**—valve is austenitic (high quality carbon steel) and valve seat is iron alloy insert. **Intake System**—valve is heat treated alloy steel. Valve seat is cast integral with cylinder. **Valve guides** are iron alloy inserts. **Valve lifters** are precision machined and heat treated. **Piston rings**—two compression and one oil ring.

GOVERNOR: Reliable internal mechanical type, with external adjustment for trained servicemen.

BREATHER: Closed crankcase vent keeps dirt and dust from entering directly into crankcase.

FUEL TANK: Top mounted tank for full fuel flow on slopes; 1½ gallon capacity with fuel strainer screen, with shutoff valve.

OPERATOR CONTROLS FROM HANDLEBARS: Control of choke, engine speed, and engine shutoff from operator position at handlebar. With electric start models, operator can start and stop engine without leaving operator position.

AIR CLEANER: Polyurethane Sponge Element type.

ENGINE WEIGHT: 53 lbs., 3 oz.

SETTINGS: Spark Plug Gap—.030". • Point Setting—.020". • Valve Clearance—.010". • Breaker Point Tecumseh Part Number 30547A. Note: Point setting for Tecumseh engine serial numbers 2336 through 3345 is .018" instead of .020".

• Condenser Tecumseh Part Number 30548A.

• Head Bolt Torque—140 to 200 in. lbs. (12 to 14 ft. lbs.)

B. 7 HP KOHLER ENGINE

GENERAL DESCRIPTION: Four cycle, single cylinder, air cooled. Recoil start is standard.

CRANKSHAFT: Heat treated ductile iron casting with integral counterweights and induction hardened crankpin.

MAIN BEARINGS: Ball bearings on both ends of the crankshaft.

LONG LIFE MATERIALS: Resistant to heat and wear. **Valves**—forged steel alloy intake valve. Heat resistant (stellite) exhaust valve. **Valve tappets**—hardened and precision ground. **Exhaust valve seat**—stellite insert. **Positive valve rotation. Piston rings**—two compression and one oil control ring.

GOVERNOR: Mechanical flyweight type, with external adjustments.

FUEL TANK: Large, 1½ gallon capacity, top mounted tank for full fuel flow on slopes.

CHOKE: Manually operated at engine.

BREAKER POINTS & CONDENSER: Readily accessible and externally mounted for quick service.

MODEL: K161T, specification number **281271**, or **281181J**.

ENGINE SHUTOFF: Stop button mounted outside on breaker point cover.

ENGINE SPEED CONTROL: Controlled from operator position at handlebar.

AIR CLEANER: Replaceable dry paper element type.

ENGINE WEIGHT: 70 lbs.

SETTINGS: Spark Plug Gap—.025". • Point Setting—.020". • Valve Clearance—(Intake) .006" to .008" (Cold); (Exhaust) .015" to .017" (Cold).

• Breaker Point Kohler Part Number 220475.

• Condenser Kohler Part Number 220434.

• Head Bolt Torque—180 to 240 in. lbs. (15 to 20 ft. lbs.)

LIMITED WARRANTY

NO TIME LIMIT

Your Troy-Bilt Roto Tiller-Power Composter and all attachments will be carefully inspected and tested at the factory. We, or your Dealer, will at any time replace any part which is defective in materials or workmanship—except for the engine (which is warranted by the engine manufacturer for 1 year; write us for details).

PLUS. . .

Please write or call us if you have any problems. If you are not entirely pleased and satisfied with your Troy-Bilt Roto Tiller-Power Composter any time within 30 days after you first use it in your garden, you may notify us or your Dealer and return it for full refund less shipping costs.

Even after your first 30 days of use, if you ever have any problems, we will make good even if it means sending you a completely new machine or having you return machine, parts, or attachments for exchange, repair or full refund of purchase price, whichever you prefer. . . except for shipping costs and an allowance for normal wear and tear.

To be eligible for this warranty, you must promptly return to us the Warranty Registration Card which comes with your new Troy-Bilt. This warranty gives you specific legal rights, and you may also have other rights which vary from state to state.

HALF-PRICE FACTORY REBUILDING AGREEMENT

At any time, no matter how new or old your TROY-BILT Roto Tiller-Power Composter may be, we will rebuild and repaint it, replacing every worn part (such as bearings, gears, seals, tines, belts and including a new engine) for one-half the current retail price at the time of repair of that model or its equivalent (if that exact model has been changed); owner to pay shipping and container costs to and from Factory. If any other than wearing parts need replacement, an estimate will be submitted to owner for approval. This offer, of course, is subject to fire, war, strikes, and other contingencies beyond our control.

The whole sense and purpose of our Direct-From-The-Factory Savings Plan, our no time limit promise and Half-Price Factory Rebuilding Agreement are to provide owners of TROY-BILT Roto Tiller-Power Composters an outstanding value both as to purchase price and maintenance cost of Rotary Tillers and attachments especially designed and built for their purposes—in return for their cooperation in spreading the good word about the Troy-Bilt to other serious gardeners—to our great and genuine mutual benefits.

Yours for good faith and fairness in all matters,



Dean Leith, Jr., Sales Manager

Garden Way Manufacturing Company, Inc.

102nd Street & 9th Avenue, Troy, New York 12180 • Telephone (518) 235-6010

BrentChalmers.com

Time Proven Gardening Tips for TROY-BILT Owners...

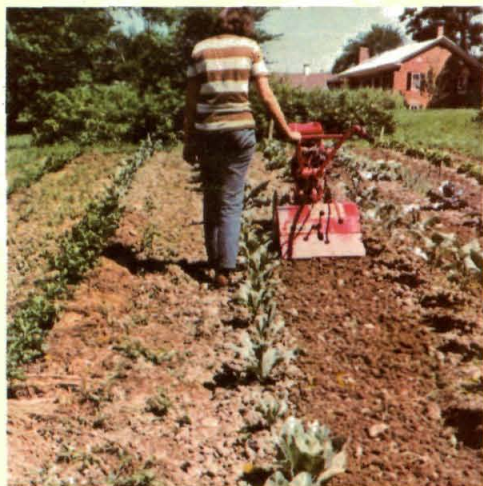

Cultivating with one hand, alongside the Troy-Bilt, avoids wheel-marks and footprints, which replant weed seeds and spoil the fine moisture-holding "dust mulch" the loosened soil just created. Troy-Bilt cultivation also chops up and tills under weeds, adding valuable organic matter.



Tilling under all residues — even standing cornstalks — destroys the winter nesting, feeding, and reproducing quarters of many garden insect pests. The sooner after harvesting the better. Tender green matter not only tills in easier, but provides that much more good food to the earthworms and soil life.



Many Troy-Bilt owners hand-broadcast buckwheat, as shown in this photo, after harvest of vegetables as a green manure crop. The quick growth helps choke out weeds and supplies a rich source of organic material when eventually tilled in. Ryegrass is popular as a cover crop to prevent winter erosion and to be tilled in as green manure the following spring.



Tilling under this nitrogen-fixing crop of soybeans is one of the fastest ways we know of to improve or rebuild soil. This tilled-in green manure will break down into humus, a sponge-like material which stores and releases moisture as needed during dry spells, and helps to drain excess surface water during wet periods. Humus is essential for breaking up heavy clay soils, and binding overly loose, sandy ones.



Vegetation you remove from your garden as harvested crops should be replaced with equal or greater amounts of organic matter to keep soil well aerated and fertile. Fall is a perfect time for tilling under leaves which will decompose by spring, releasing a bounty of important trace minerals drawn from the subsoil by tree roots.

Without a doubt, earthworms are a gardener's best friends. These useful creatures burrow throughout the soil, aiding drainage with their channels, and digesting huge amounts of raw vegetation, turning it into tiny enough particles of fertilizing nutrients that plant root hairs can absorb. This high yielding, "power-composted" Troy-Bilt garden is a paradise for earthworms!



For more information, please read pages 65 to 76 inside this manual entitled, "Using Special Troy-Bilt Gardening Methods."

BrentChambers.com