

OWNER'S MANUAL SUPPLEMENT

FOUR-SPEED HORSE MODEL

TROY-BILT® ROTO TILLER

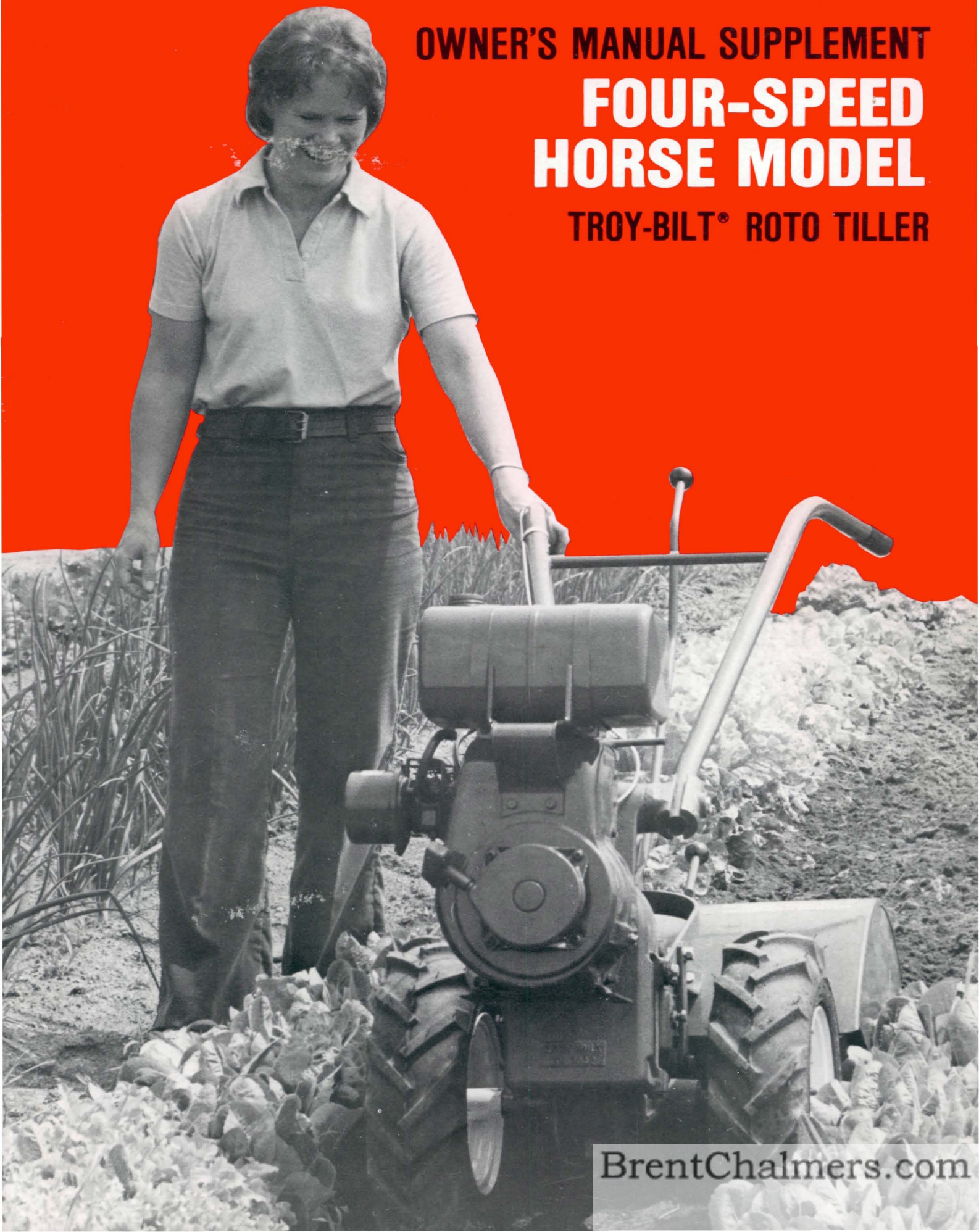

BrentChalmers.com

HERE'S GOOD NEWS!

Now, your new Troy-Bilt Roto Tiller-Power Composter is even more versatile than you thought when you purchased it. We've improved the design by adding two speed ranges to your tiller. So now, instead of two wheel speeds forward, you'll have a choice of four wheel speeds, and you'll also have two tine speeds instead of one. These extra wheel and tine speed selections have been accomplished by several major improvements in design and they give you much greater versatility in the garden. Now, there is a speed that matches every tilling task and situation in the garden, while you get maximum tilling results for each task. There is even a speed for old people, young people and those in a hurry such as custom tillers who earn money tilling, or others who do extra gardens for family and friends.

In general, many people will find that High Range and Low Gear (Slow Wheel Speed) will perform most tilling chores very well, except those under

very hard, and tough conditions. For instance, in tilling tough sod on previously unworked land, if you try to work too fast you won't get the job done. So, you'll have to throttle back a little. If you find that in doing so, you aren't getting enough engine power, then moving the belt back to Low Range and tilling in Low Gear will provide you with more power at the slower speed you want.

On the other hand, High Range and High Gear offer some people the perfect combination to prepare new seedbeds in well tilled soil and cultivate at speeds fast enough to get the job done quickly at a lower engine throttle setting that saves wear and tear on the engine and doesn't require as much lifting of the handlebars to keep shallow. You can see from the table on page 1 that there are many tasks and many speeds with the combined use of the throttle, belt ranges and wheel gear shifting that permit you to tailor your tiller's action to your needs.

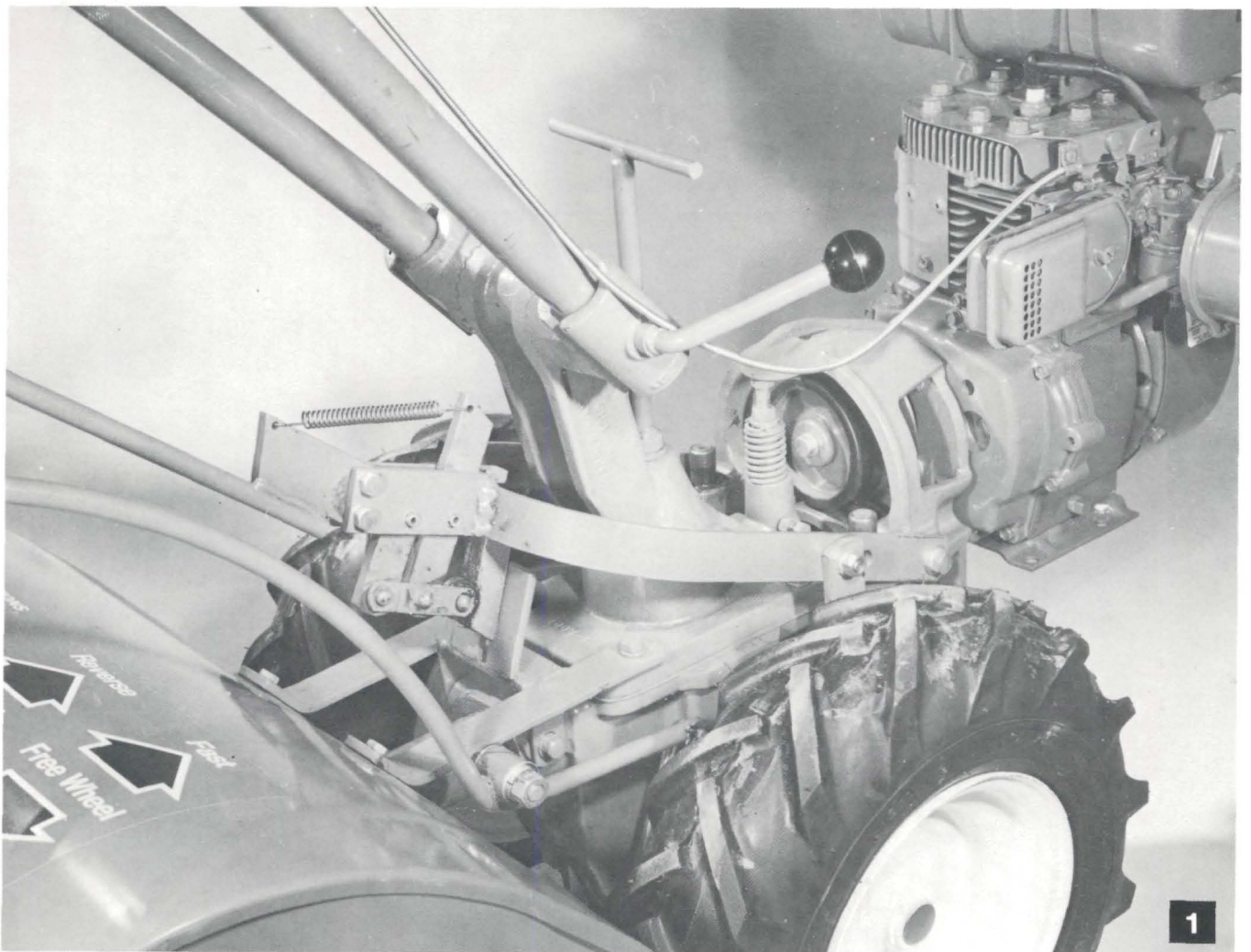

TROY-BILT® is a registered trademark of Garden Way Manufacturing Company, Inc., Troy, New York

BrentChalmers.com

TABLE: Wheel Gear and Pulley Range Choices

LOW GEAR, LOW RANGE	LOW GEAR, HIGH RANGE	HIGH GEAR, LOW RANGE	HIGH GEAR, HIGH RANGE
<p>Till in sod Till hard clay Till in corn stalks Till in cover crops Prepare very deep seedbed Till in stony soil Till in residues and organic matter Mix in fertilizers and manures</p>	<p>Till in sod Till hard clay Till in corn stalks (in most cases, much faster) Till in cover crops (faster, better job in most soils) Prepare seedbeds (in most soils better and faster) Till in stony soils Make raised beds Mix in fertilizer Prepare seedbed for tilling very fast Pull hiller in hard clay soil Mix fertilizer and manure Till in residues and organic matter (As good or better in all but very hard, tough conditions)</p>	<p>Prepare last time over seedbed for planting vegetables and cover crop Cover seed in wide row or plot planting. (In some soil, handlebars must be held up to keep from going too deep) Hill and furrow very well Raise beds easily Cultivate. In some soils you may have to hold up on handlebars to avoid going too deep. Handy in keeping large areas tilled or farrowed for a season to improve soil Till in some organic matter in good soil Mix in lime</p>	<p>Prepare seedbeds for planting cover crops Mixing in lime Cover seeds with less holding up on handlebars (faster than low range) Cultivate (excellent, saves engine because you don't have to run it wide open, nor hold up handlebars — with rare exception — because it travels faster and stays on top) Keep large areas tilled or farrowed through summer (saves a lot of time) Till in some organic matter. Moving tiller from one place to another (Does many jobs better and faster)</p>

SINGLE BELT RESULTS IN PULLEYS WITH HIGH & LOW RANGES

The latest improvements in belt technology have allowed us to use a single, stronger, more durable belt instead of two belts. The belt is made of a fiber that is stronger than steel and is used on the latest automobile tires. Use of a single belt enabled us to install pulleys with two speed ranges instead of a single speed pulley — see Photo 2. Moving the belt from one position to the other on the top and bottom pulleys changes the tiller's speed range — see Sketches. More about that later. Let's turn to the four wheel speeds.



PULLEYS HAVE TWO SPEED RANGES

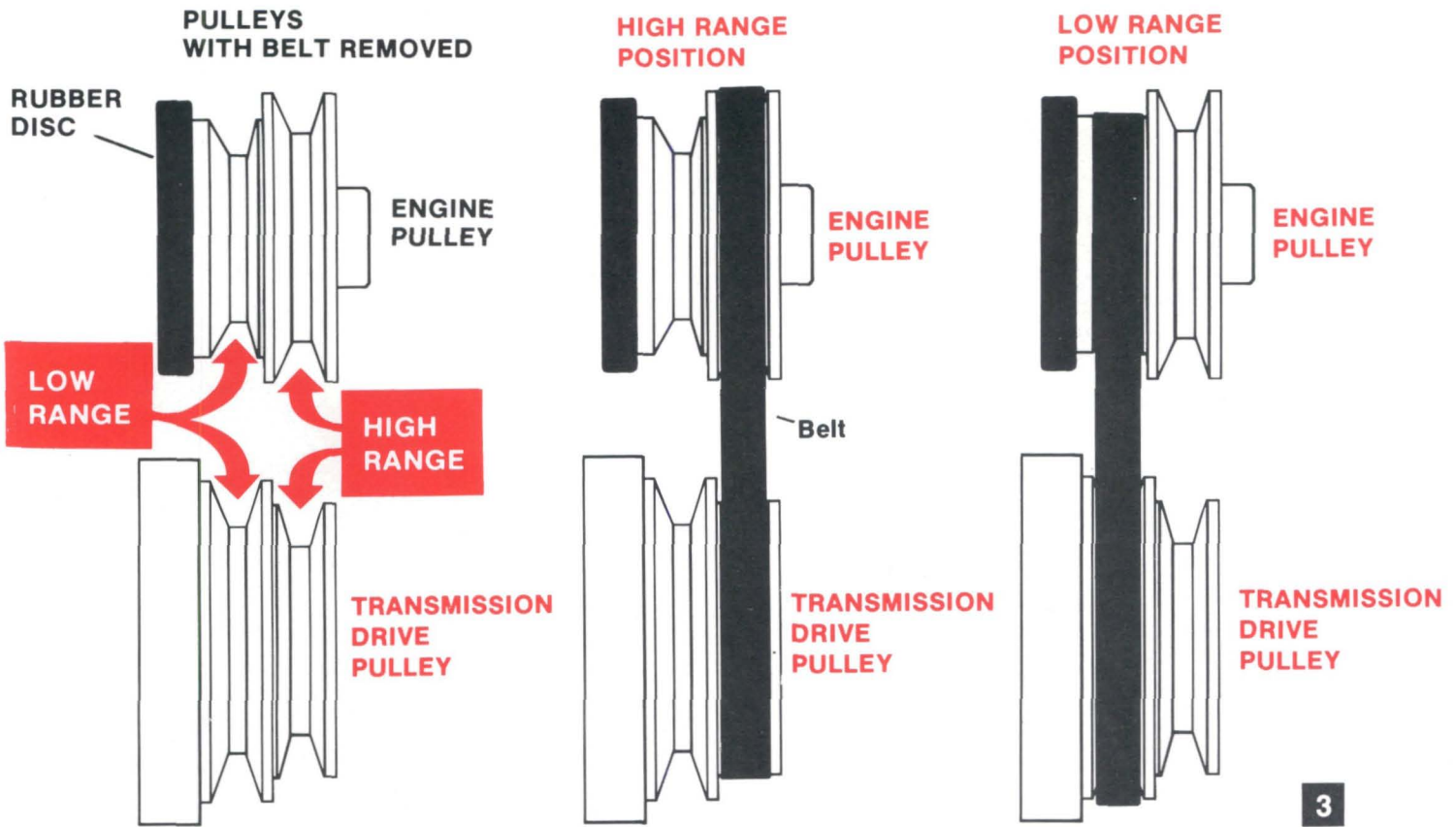

FOUR WHEEL SPEEDS

Since you still have a high and low gear selected with the Wheel Speed Shift Lever, you now have a four-speed tiller. You get the four speeds by using the belt in the HIGH RANGE or LOW RANGE position of the pulleys (see Photo 4) and then by shifting the gears with the lever to FAST or SLOW.

Shifting gears with the belt in HIGH RANGE, gives you two wheel speeds (see Photo 5). Then, moving the belt to the LOW RANGE position and shifting the lever into FAST or SLOW provides two different wheel speeds — see Sketches 5A & B, and 6A & B.

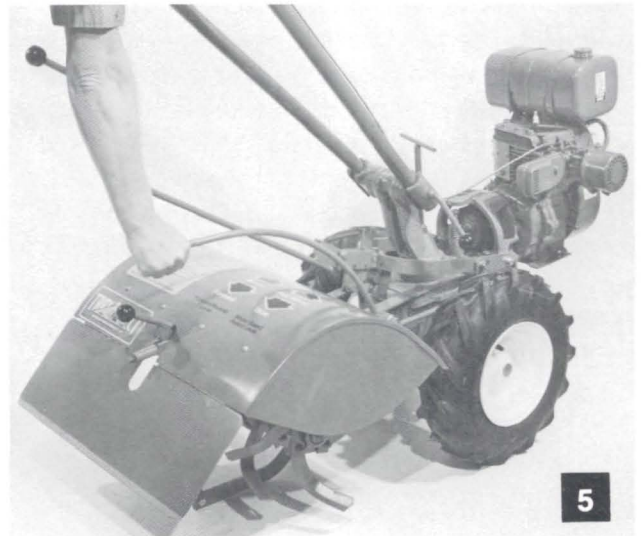
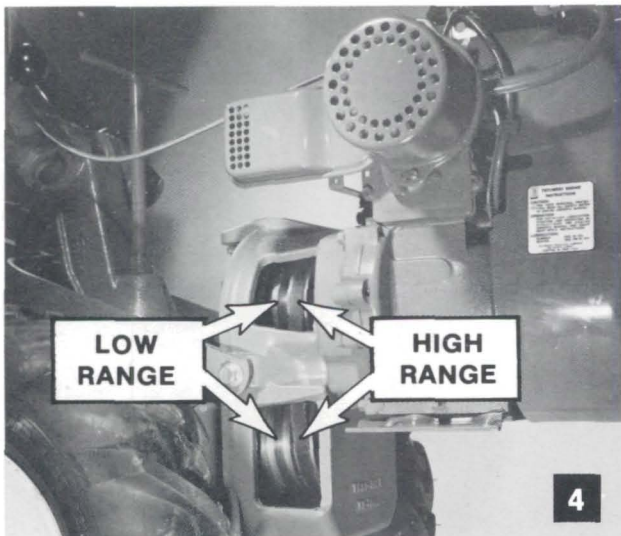

Four-Speed Tiller — By using HIGH and LOW ranges of the pulleys, and shifting the wheel gears to FAST or SLOW, you achieve four different speeds for all tilling conditions.

HIGH RANGE

Sketch 5A

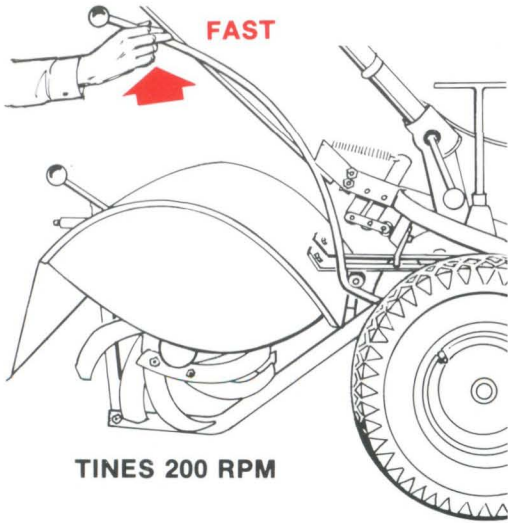

TINES 200 RPM

WHEELS 1.72 MPH

HIGH RANGE

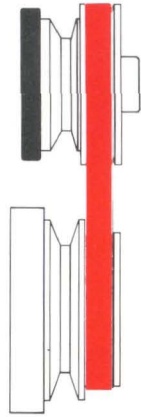

Sketch 5B

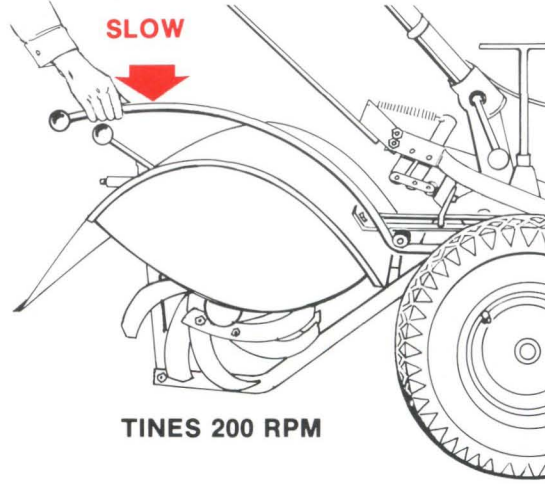

TINES 200 RPM

WHEELS .70 MPH

HIGH RANGE

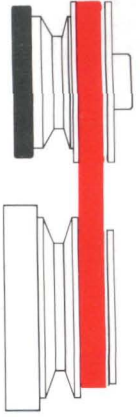

LOW RANGE

Sketch 6A

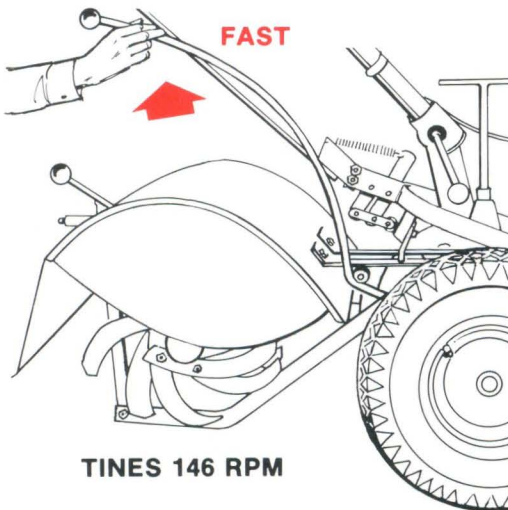

TINES 146 RPM

WHEELS 1.2 MPH

LOW RANGE

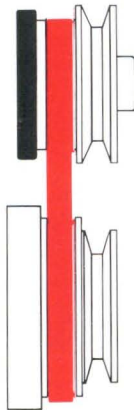

Sketch 6B

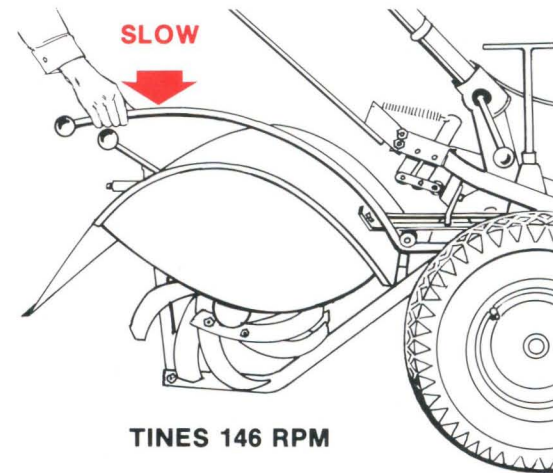

TINES 146 RPM

WHEELS .5 MPH

LOW RANGE

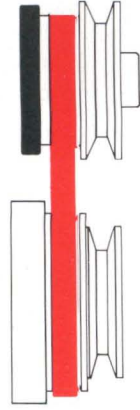

TWO TINE SPEEDS

Engine speed and the position you select for the belt (High or Low Range) combine to determine the tine speed. The engine speed determines how fast the upper pulley turns. The belt turns with the engine pulley and turns the transmission drive pulley, which rotates the main drive shaft and finally the tiller shaft in the rear. So, putting the belt in HIGH RANGE (Photo 7) results in a tine speed of 200 RPM (revolutions per minute) — see Photo 8. In LOW RANGE, the tines revolve at 146 RPM — see Photo 9. Both tine speeds are based upon an engine speed of 3,000 RPM (which is about as high an engine speed as most people want to go). Sketch 10 shows how the engine powers the wheels and the tines.

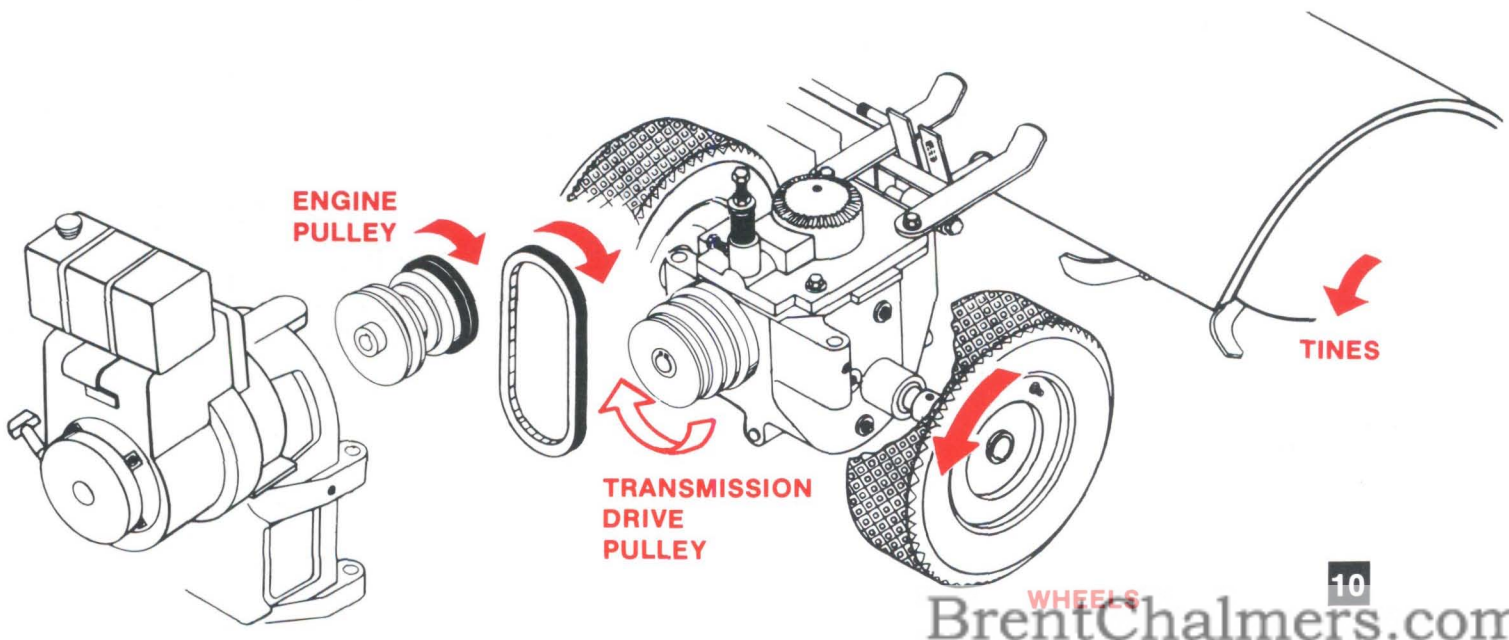
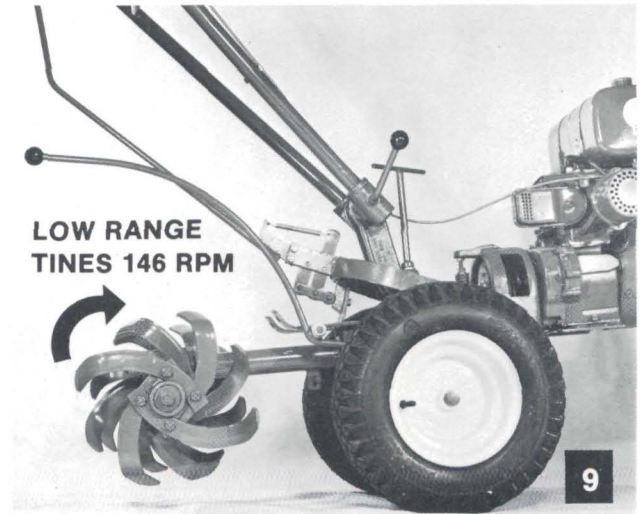
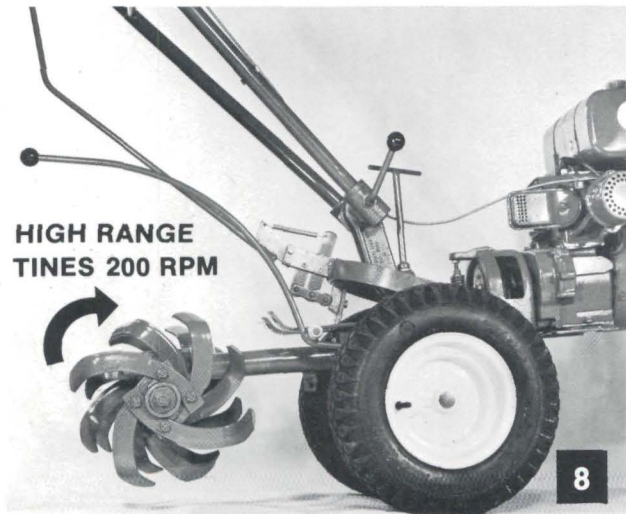
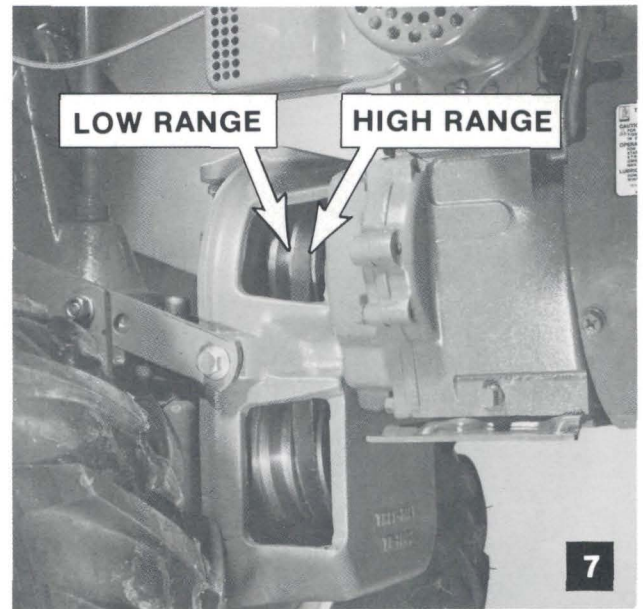

WHEN YOU ATTACH THE FORWARD/REVERSE LEVER HERE'S A SPECIAL STEP TO FOLLOW

When attaching the Forward/Reverse Lever as shown in the Easy Assembly Instructions in Section 1 of your Horse Model Owner's Manual, make sure that you don't overstretch the clutch pawl spring (part #1492). It helps to attach the lever before attaching the handlebars. Also, add only one bolt and raise the lever to attach the spring while it is not under any tension. Next follow the additional step in the next paragraph.

In addition to the instructions found on page 21 STEP 4 of your Owner's Manual, you should pinch the ends of the spring flat alongside the plate and vertical link of the Forward/Reverse Lever assembly as shown in Photo 11.

When the spring is attached by the two holes, then align the lever's bolt holes and add the second bolt to the assembly.

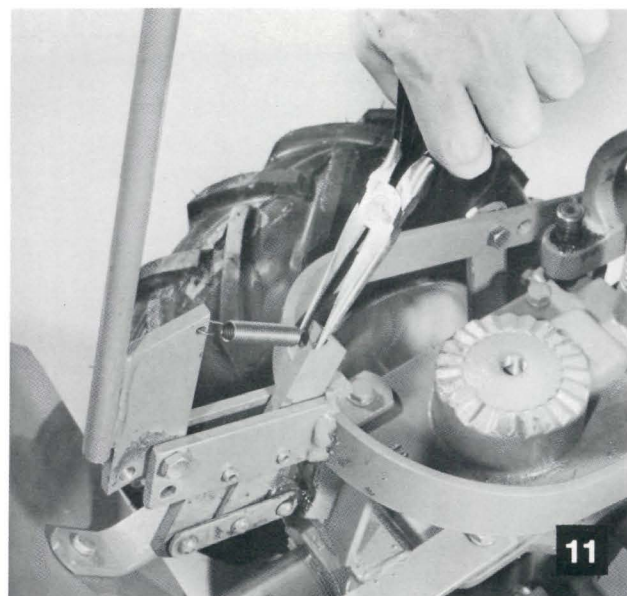

While spring is relaxed, pinch end flat against link.

TO CHANGE THE SPEED RANGE FROM HIGH RANGE TO LOW RANGE

(If the engine has been running and the muffler is hot, wait until the muffler cools down.)

1. Shift the Forward/Reverse Lever into Neutral (Photo 12).

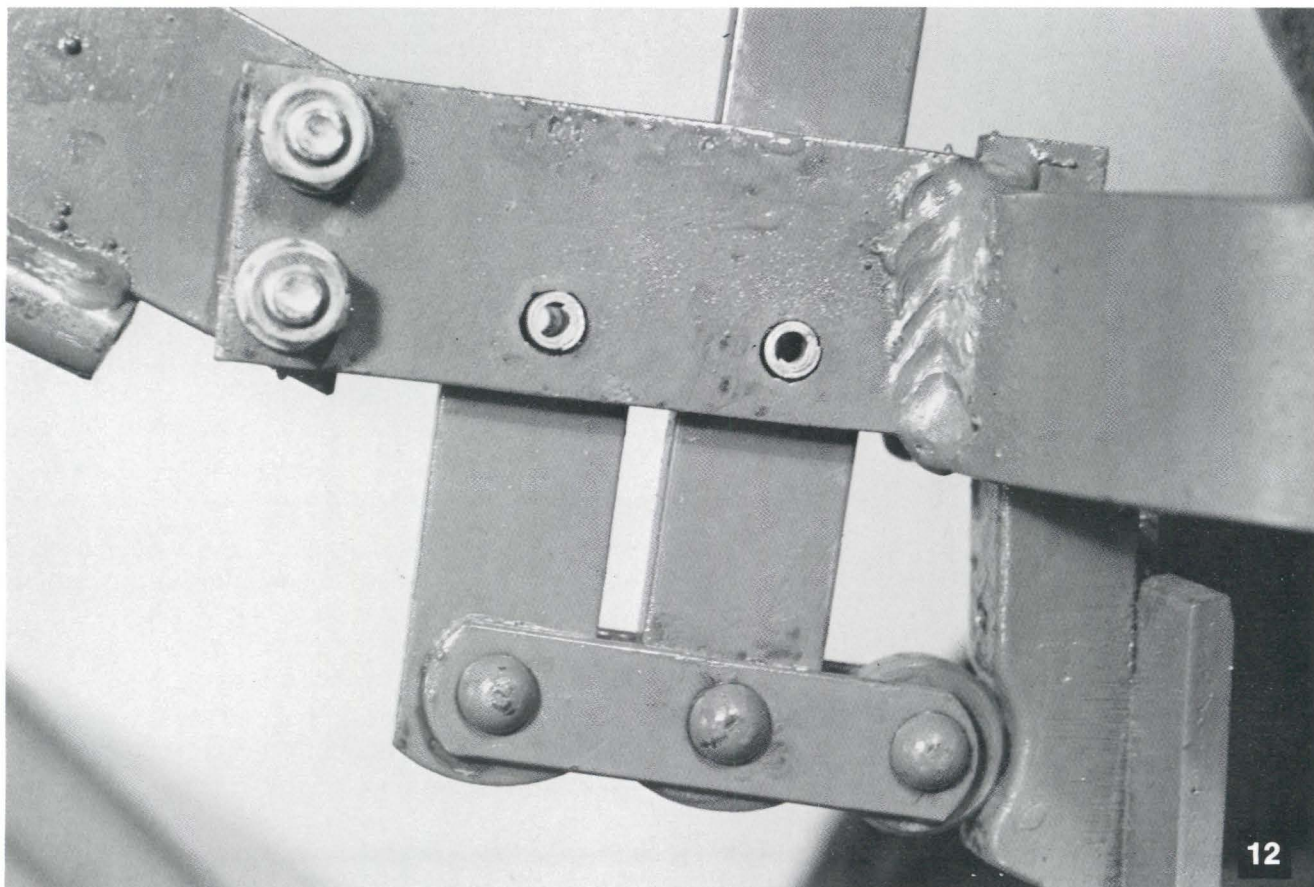

2. Stand on left side of tiller. Hold the Forward/Reverse Lever up in Reverse with one hand while you move the belt on the engine pulley (top pulley) over the pulley groove as shown in Photo 13.

Do this first on the left side as shown in Photo 13 and then on the right side as shown in Photo 14.

3. Next, you will have to seat the belt in the lower pulley as you hold the lever up toward Reverse — see Photo 15. Move the belt out of the lower pulley groove and into the next groove. Just make sure that the belt is in the upper and lower pulley grooves that line up.

Work first on one side, and then on the other. It's relatively easy to do even the first time, although it might seem complex. After you have done it three or four times, it becomes very easy to do.

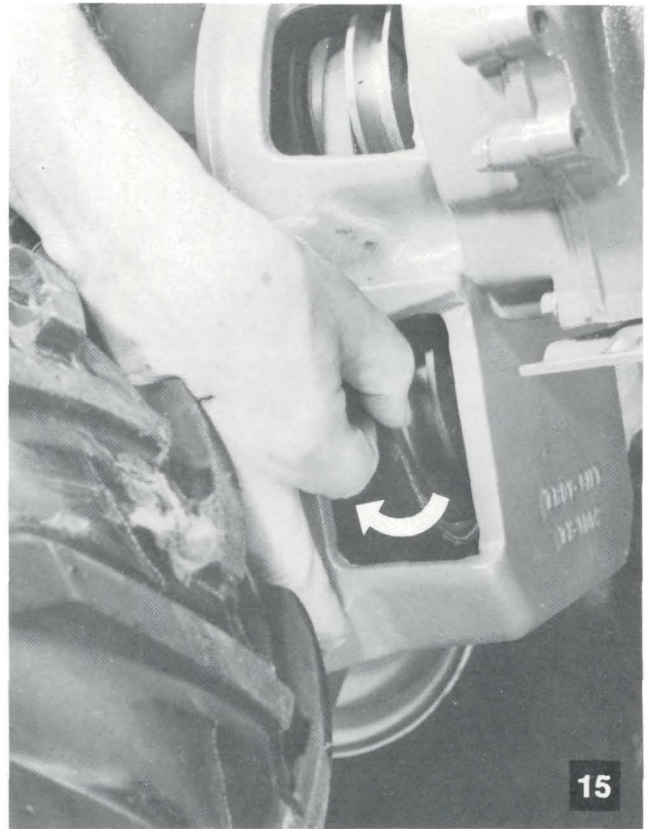
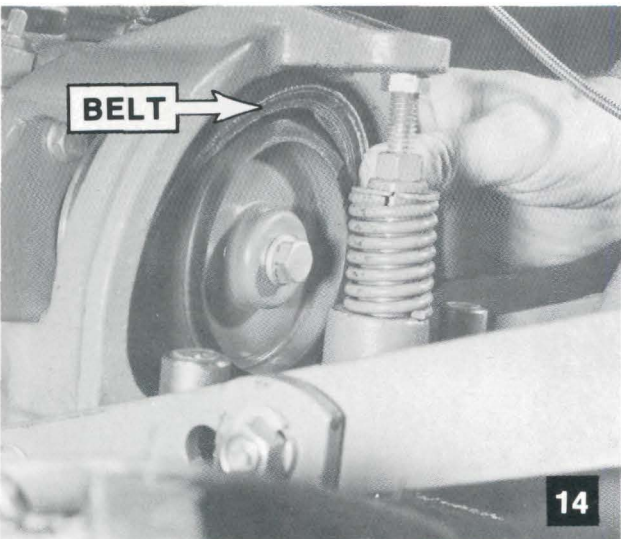
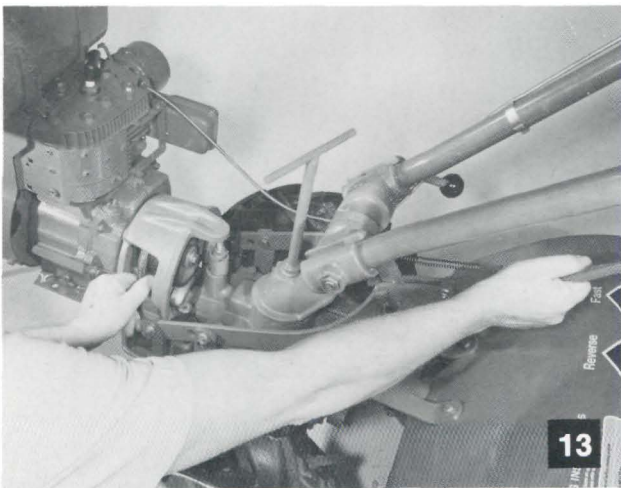

CHANGING FROM LOW TO HIGH RANGE

1. Shift the Forward/Reverse Lever to Neutral — see Photo 12.

2. Stand at left and reach around the engine mount and push in with your finger at the midpoint on the right side of the belt as shown in Photo 16. This will give you slack in the belt. Then, move the belt on the transmission drive pulley (lower pulley) out of the bottom of the groove into the next groove (closest to the engine). Seat the belt in the groove.

3. While on the left side of the tiller, move the belt out of the groove on the top pulley.

Then, leave the belt partially in the groove and move around to the right side of the tiller. Caution: **BE VERY CAREFUL IF THE MUFFLER IS HOT, WAIT UNTIL IT COOLS DOWN.** Now, reach through the opening on the side of the engine mount and seat the belt in the groove. It will easily go where finger points — see Photo 17. If you need more room to get it over the pulley, pull the Forward/Reverse Lever up toward Reverse to bring the pulley closer together and give you more slack.

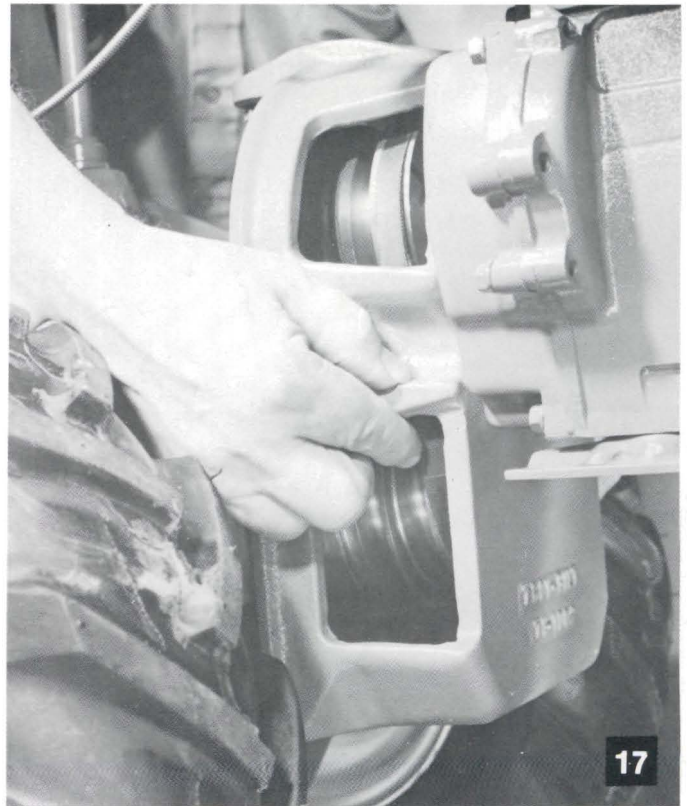
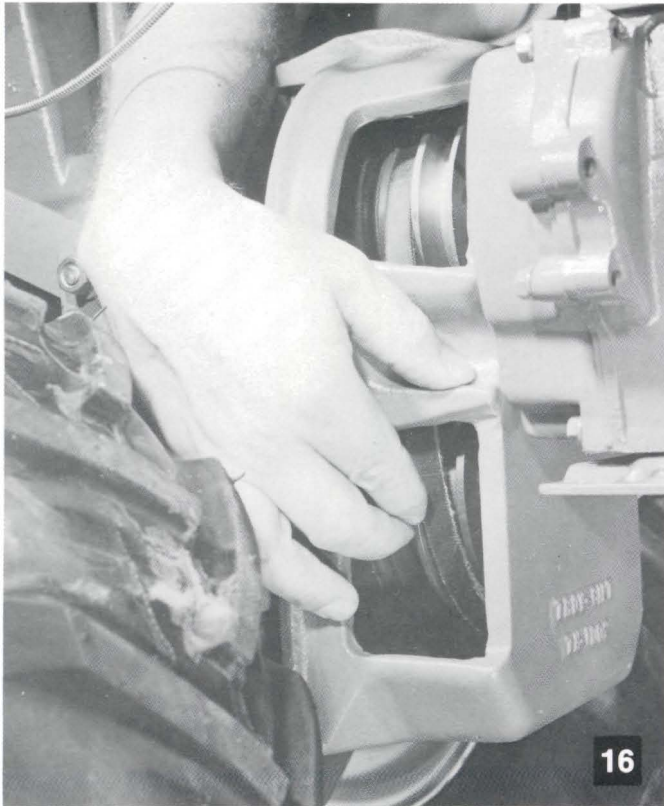

HOW TO REMOVE BELT

(If the engine has been running, wait until the muffler and the engine cool down. Also, disconnect sparkplug wire.)

1. Shift Forward/Reverse Lever into Neutral.
2. While you're on the right side of the tiller, reach over engine mount and push belt toward you with fingers to give you slack, then reach through the bottom opening and move the belt at the transmission drive pulley down and away from the pulley, moving it toward the engine — see Photo 18. Then, once it is off of the pulley, push the belt over to the left of center.

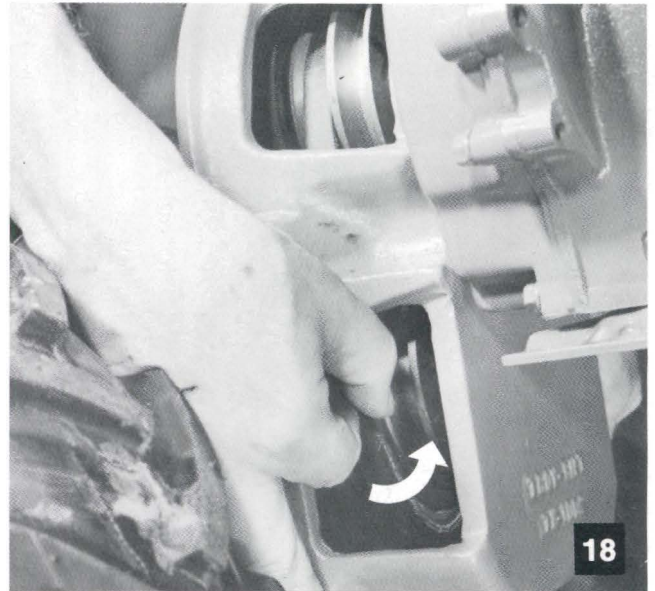

3. Now with the belt fully off the lower pulley, push the belt upward with your finger — see Photo 19. This will make more slack to remove it from the engine pulley.

4. Working on the left side, lift the belt up and over the rubber reverse disc — see Photo 20.

5. Once you have moved the belt over the rubber reverse disc, move it down in front of the disc. Now, shift the Forward/Reverse Lever into Forward. Then, raise the lower end of the belt out from behind the bottom pulley. Next, pull the belt out from between the two pulleys and out the front, left side as shown in Photo 21.

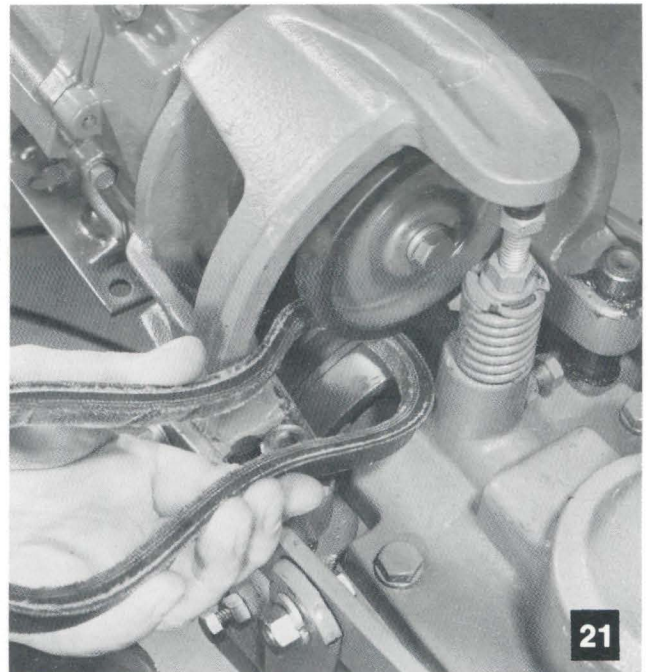
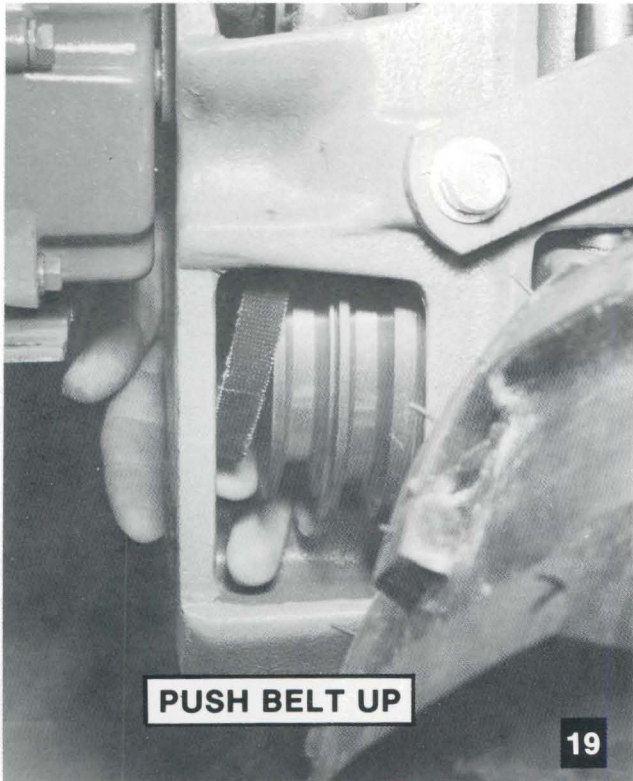
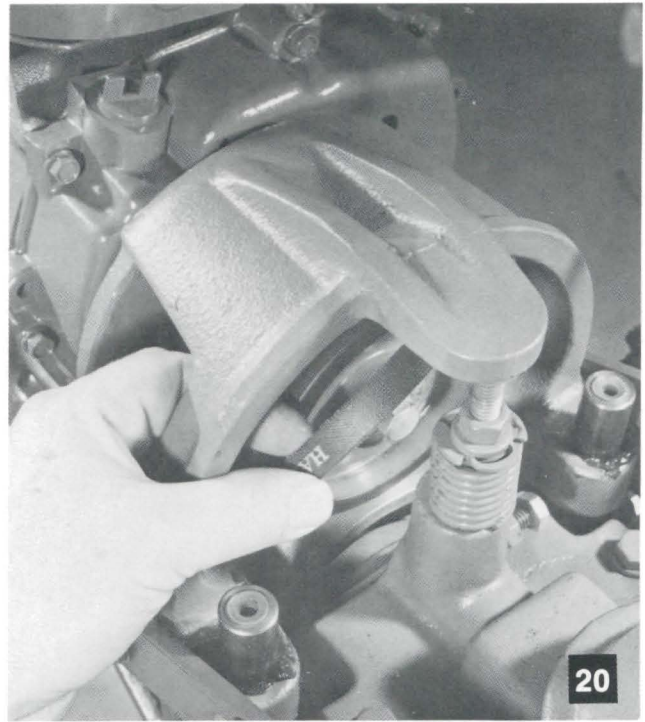

REPLACING THE BELT

(Make sure your engine and muffler are cooled and the spark plug wire is disengaged before you begin this procedure)

- 1.** Shift the tiller into Forward with the Forward/Reverse Lever. Then, take a new belt and squeeze it between your finger and your thumb as shown in Photo 22 and insert it between the two pulleys.
- 2.** Push the belt all the way back between the two pulleys so that it's almost ready to go over and down under the lower pulley (Photo 23).
- 3.** Work the belt **DOWN** behind the lower pulley — but not in the groove yet. At the same time, work the top of the belt **UP** and over the rubber reverse disc — see Photo 24. Now it's simply a matter of seating the belt in the coinciding upper and lower pulleys according to the speed range you choose. We'll show you the **HIGH RANGE** choice here.

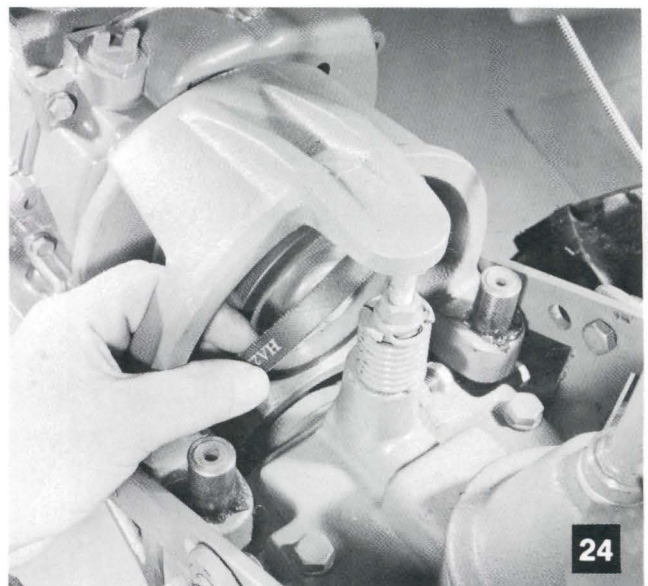
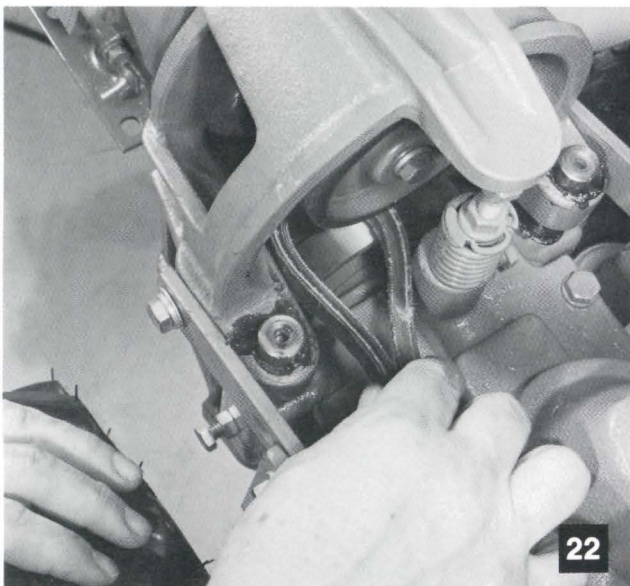
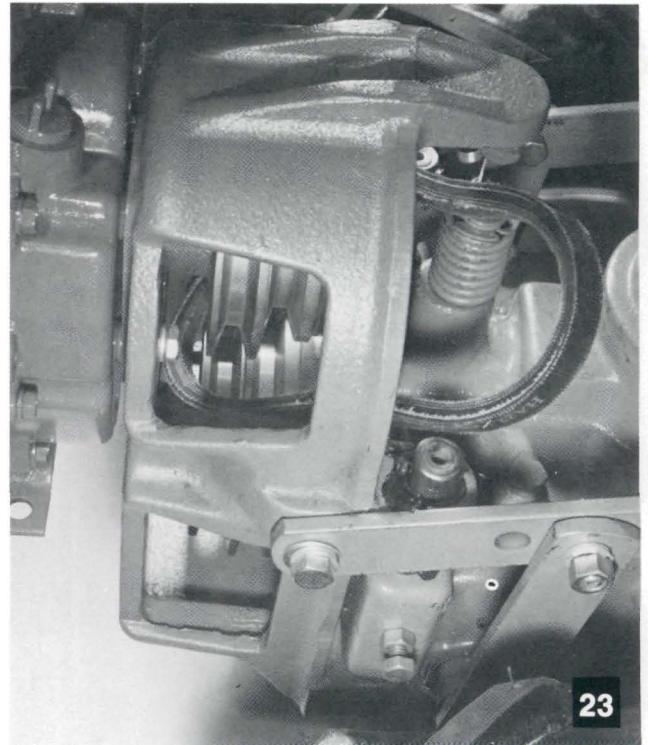

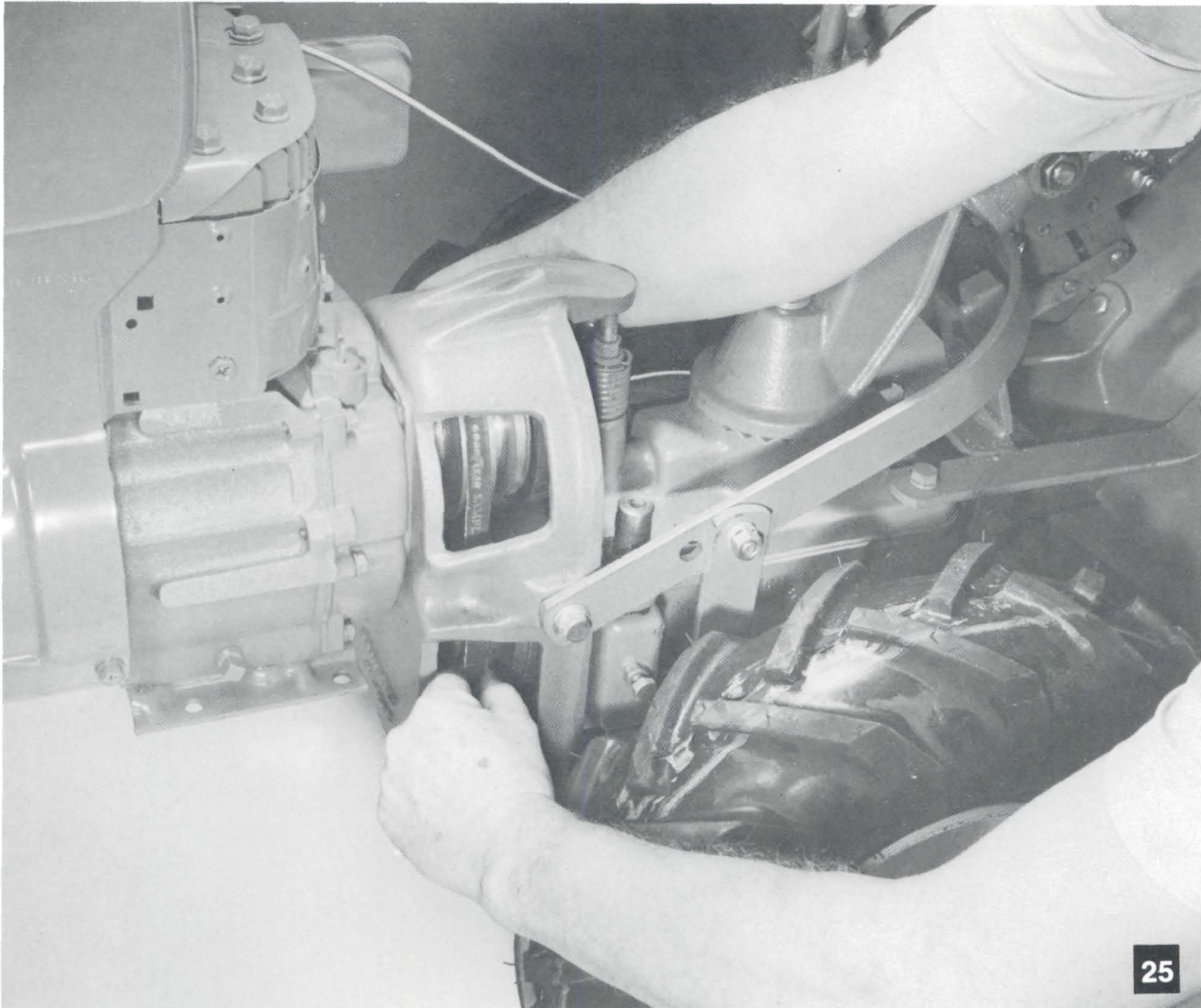

4. Working on the left side, seat the belt completely into the groove of the engine pulley (top pulley). Use the groove closest to the engine. Then, simply reach around the engine mount with your right hand and use one finger to push the belt into the transmission pulley groove closest to the engine — see Photo 25.

Then, pry the belt with your fingers of your left hand into the pulley groove on the left side — see Photo 26.

Please remember when you find it difficult to move the belt into (or out of) a groove, you should hold the Forward/Reverse Lever UP to bring the pulleys closer together to give you slack.

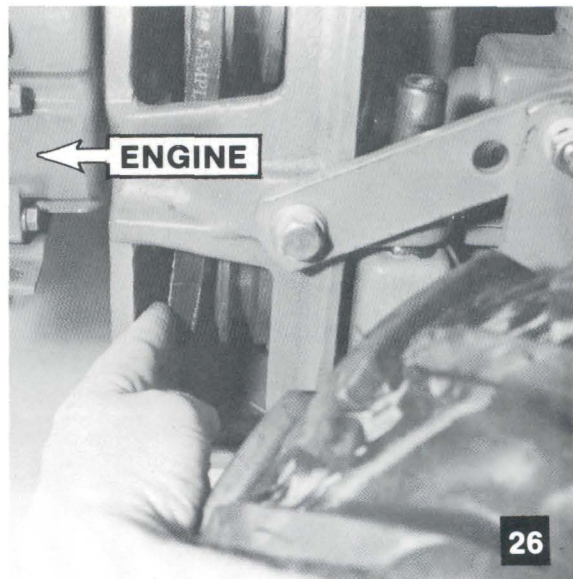

TESTING BELT & REVERSE DISC

1. Shift the Forward/Reverse Lever into Neutral, then while the spark plug wire is disconnected, pull the engine starter rope and the engine pulley should turn but the belt and lower pulley should not turn — see Photo 27.

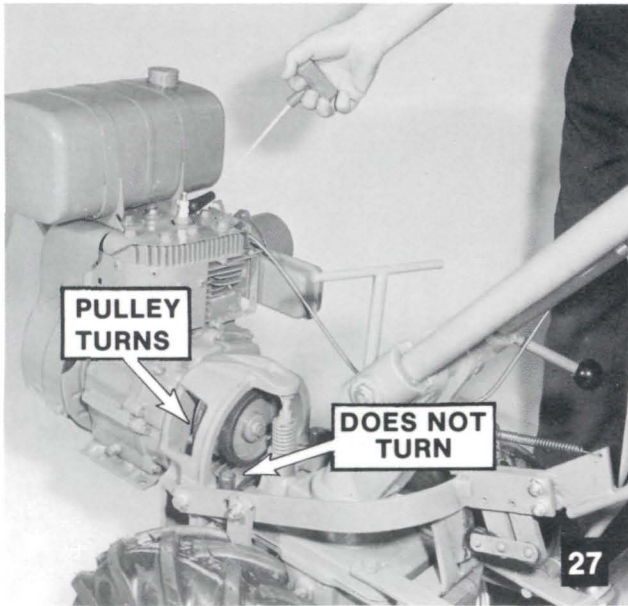

2. Lift the Forward/Reverse Lever into reverse and pull the throttle rope again — see Photo 28. The lower pulley should turn with the disc and upper pulley. Now, you have completed belt removal and replacement and you are ready to use your tiller.

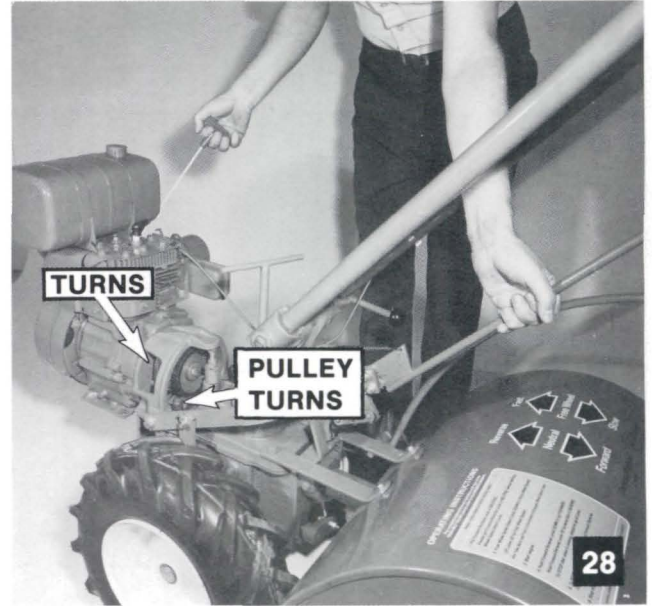

Replace a torn or cut belt if it ever looks a little bit like this.

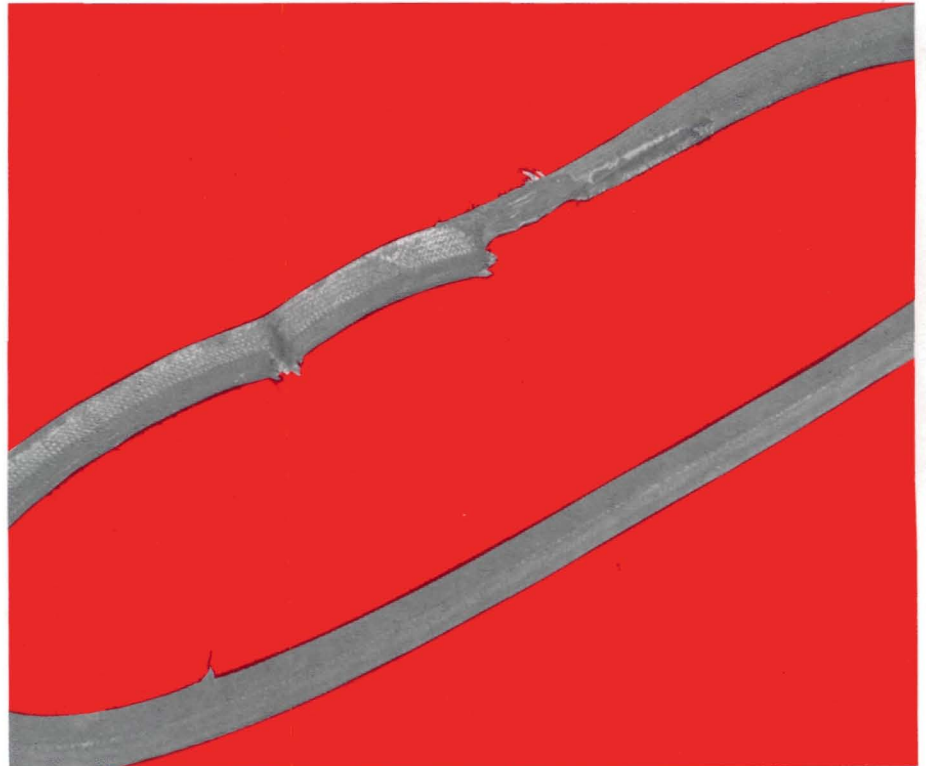

REMOVING THE RUBBER REVERSE DISC

Your reverse disc has a steel disc with a special long-lasting rubber bonded to the rim.

(Disconnect the spark plug wire).

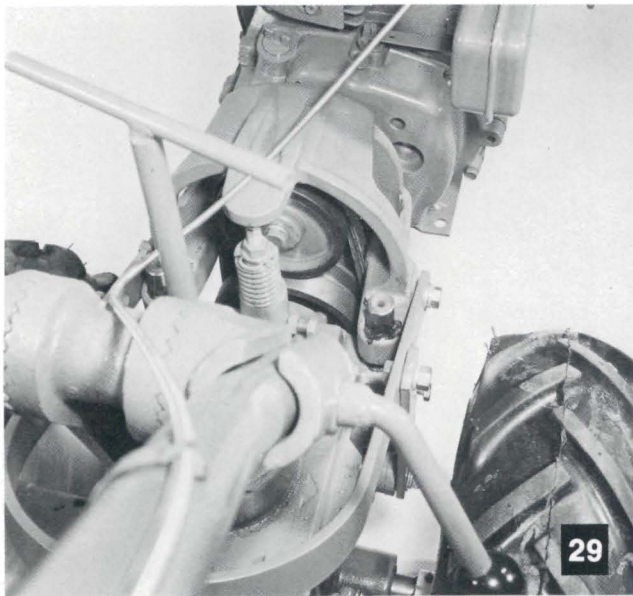

TO REMOVE THE RUBBER REVERSE DISC

1. Wedge the stick under the left side of the mount between the engine pulley and the mount as shown in Photo 31. Make sure the stick is on the portion of the pulley without the belt. Pull up on the board hard enough to hold the pulley still while you use the 9/16" wrench to push down counterclockwise on the rubber reverse disc's mounting bolt as shown in the photo. Pulling up on the stick and pushing down on the wrench should break the bolt loose. As shown in Photo 32, unthread the bolt completely from the engine's power takeoff shaft and proceed to the next step.

2. Put the screwdriver behind the rubber reverse disc as shown (in Photo 33) where the disc and the cast iron pulley meet. Using your hand, tap the screwdriver to move the disc away from the pulley. It should come loose easily.

3. Move the rubber reverse disc outward until it contacts the bolt head, then turn the reverse disc in your direction (facing a little to the right) as shown in Photo 34.

4. Simply remove the mounting bolt and washer as shown.

5. Next, you can easily remove the rubber reverse disc (Photo 35).

Tools you'll need:



A rubber mallet



A 9/16" box wrench



A large screwdriver



A short length of strong stick; 5/16" thick, about 1 3/4" wide, and about 12"-14" long.

30



If a chunk of rubber ever breaks away from your Rubber Reverse Disc, replace it immediately. Check for such things occasionally, but you should get very long wear out of it.

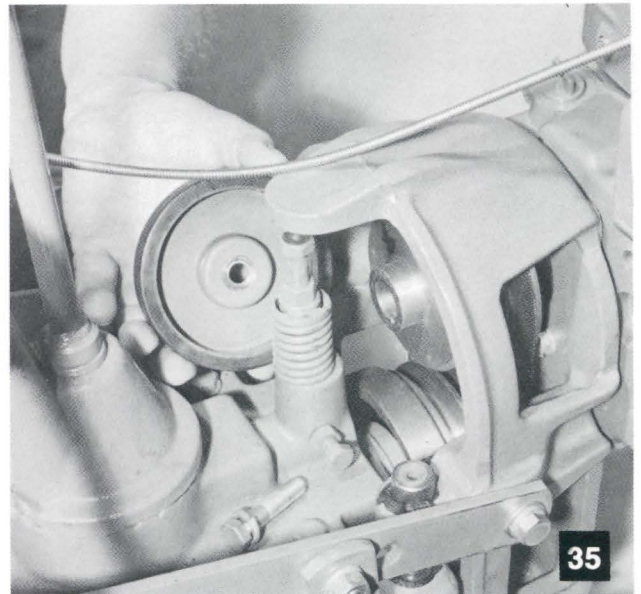
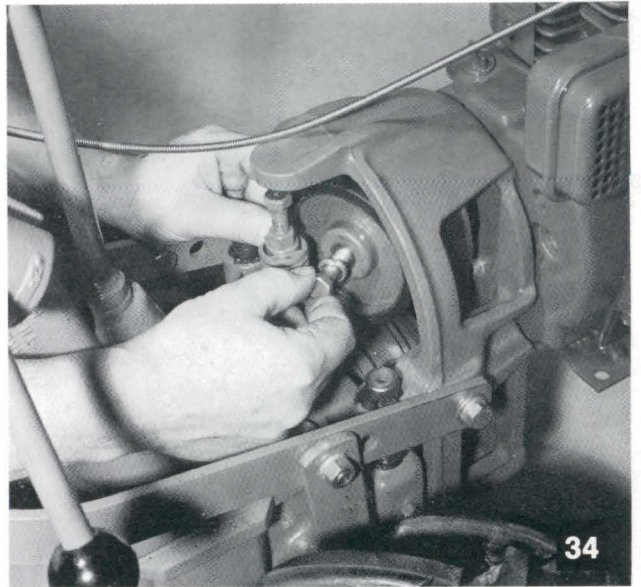
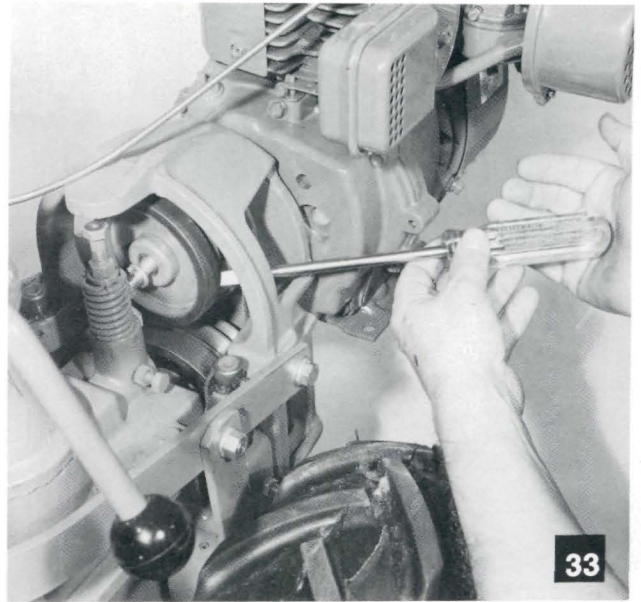
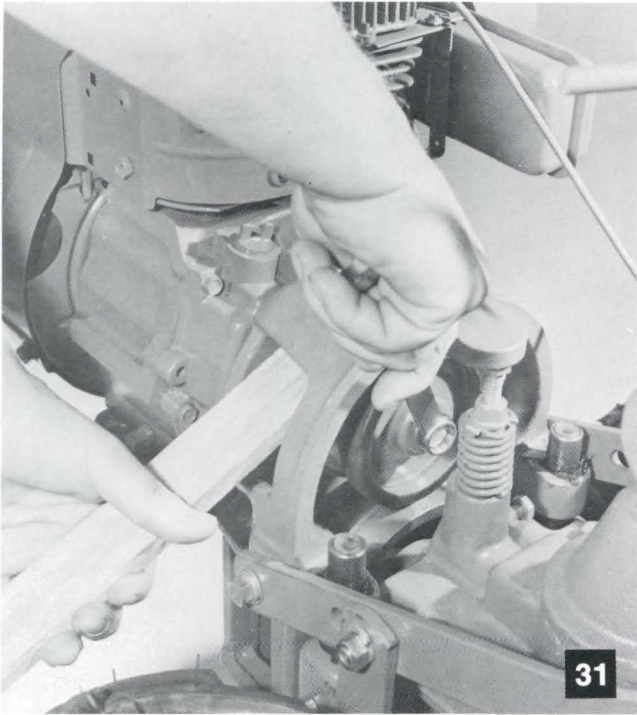

Unthread the bolt all the way out until it touches the reverse spring and plunger.

REPLACING THE RUBBER REVERSE DISC

Put your tiller's Forward/Reverse Lever in Neutral.

Put the rubber reverse disc in front of the engine pulley and angle it as shown in Photo 36. Make sure that the shoulder of the disc faces out.

2. Put the lockwasher on the bolt and push the bolt through the hole in the rubber reverse disc.
3. Once the bolt is through the rubber reverse disc, put the reverse disc on the hub of the engine pulley. Keep the bolt with the disc.
4. Thread the bolt into the hole with your fingers as far as you can.
5. Now, working from the right side of your tiller put the stick in between the groove (without the belt) and the engine mount — see Photo 37. Don't put the stick on the rubber reverse disc. Pull up hard on the stick and tighten the mounting bolt with a wrench.

You'll note that in replacing the reverse disc, you wedge the stick between the upper pulley and the motor mount from the right side. This is to give you a better hold since the pulley will be turning to the right when you try to tighten the bolt. When you're trying to loosen the bolt you wedge the stick on the left side of the engine pulley so that the tightening action moves toward the stick instead of away from it.

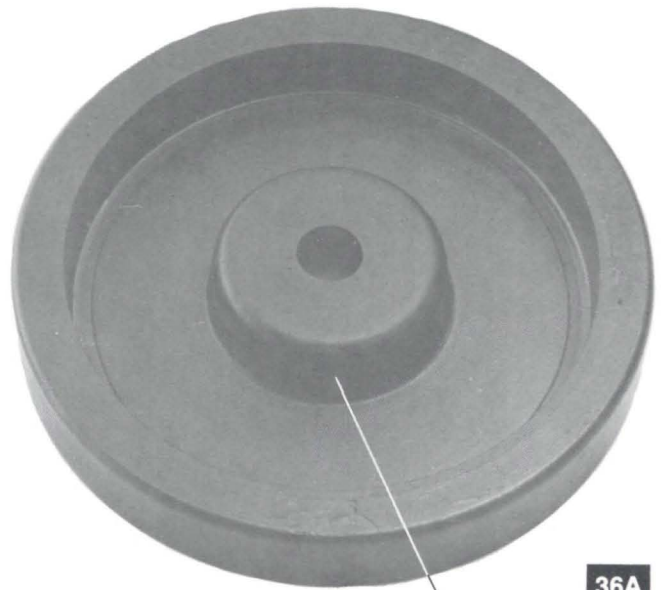

SHOULDER

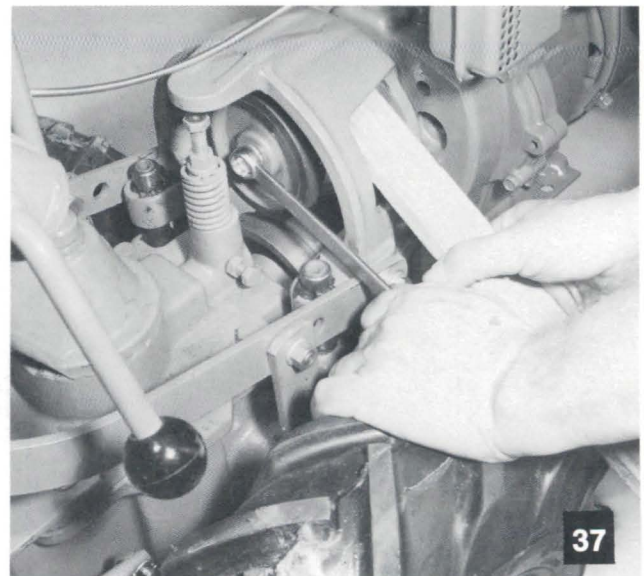
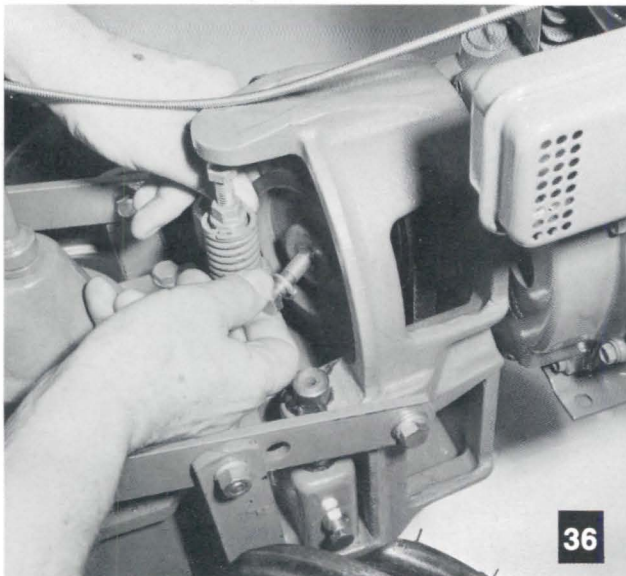

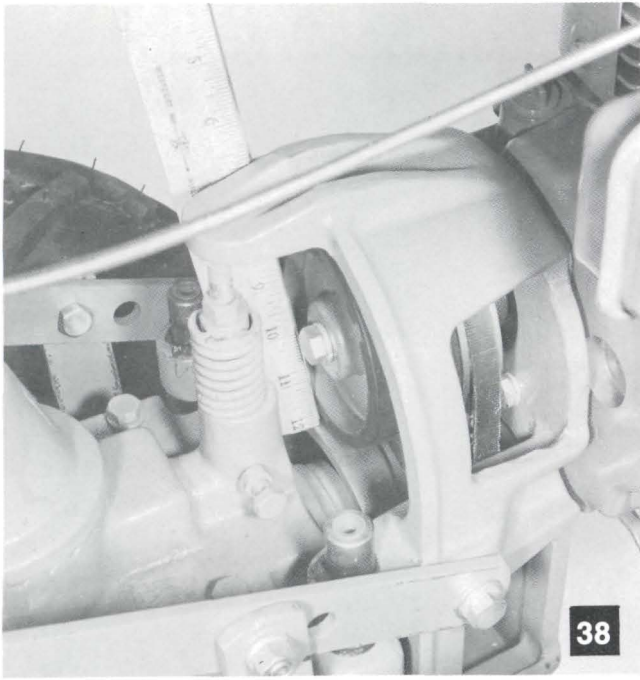

CHECKING REVERSE ADJUSTMENT

Whenever you find the tiller is likely to go in Reverse as you try to move the lever from Forward to Neutral, or if it is very difficult to move the tiller in Reverse, your tiller needs a "Reverse Adjustment." It's a simple matter to loosen the locking nut between the spring and the adjustment bolt on top, and then adjust the bolt up or down as needed.

HERE'S HOW TO ADJUST YOUR REVERSE ACTION

When the tiller's Forward/Reverse Lever is in Neutral position, the Rubber Reverse Disc should be $\frac{1}{4}$ " above the flat surface of the transmission drive pulley as shown in Photo 38. If the disc is closer than that, use two $\frac{9}{16}$ " wrenches to loosen the locking nut so that you can thread the adjustment bolt up. To move the bolt upward, turn the bolt counterclockwise as shown in Photo 39.

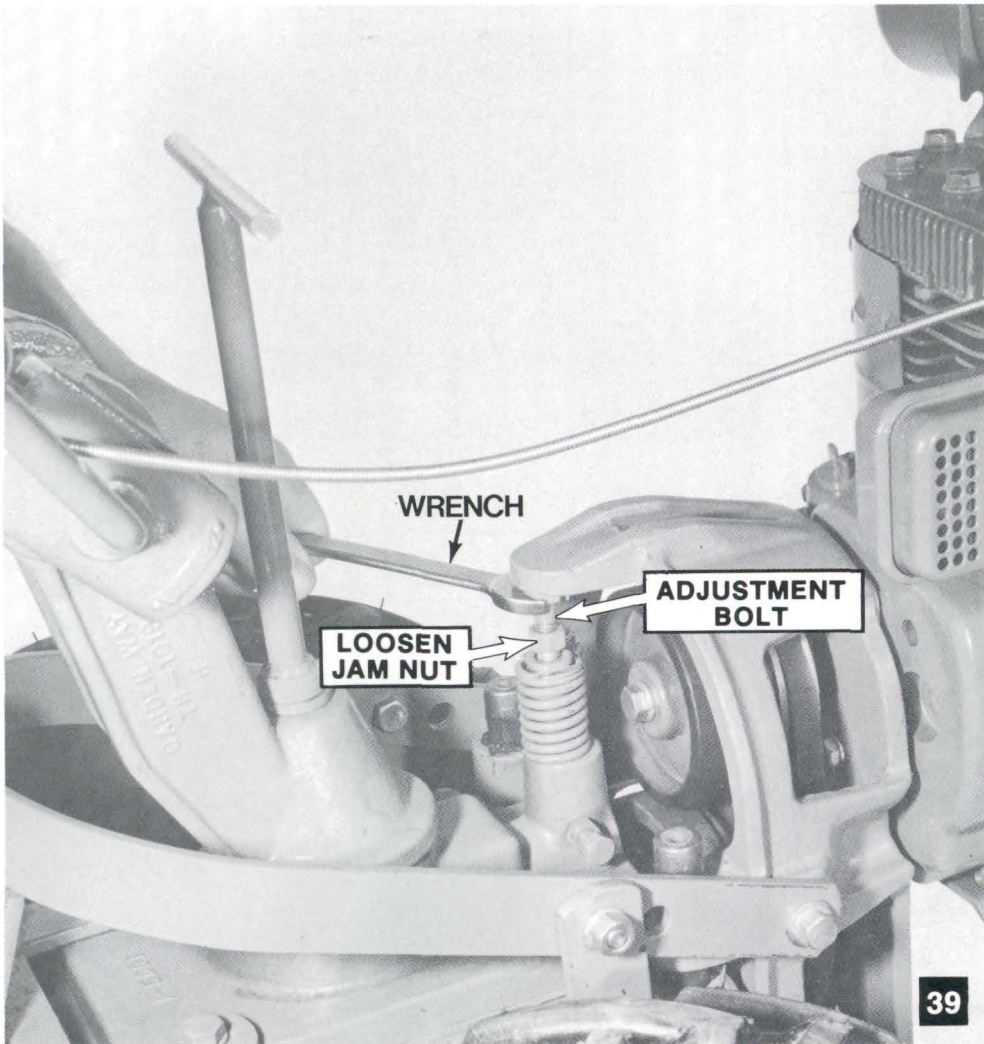

Check to make sure the Reverse Disc is the correct height and then use two 9/16" wrenches — one to hold the bolt steady in position, while you tighten the locking nut with the second wrench — see Photo 40. If, in the course of tightening the nut — or loosening the bolt — the spring and the plunger turn and defeat your purposes, then lay down one wrench and place a pair of pliers on the top of the plunger near the retaining clip as shown in Photo 41. This will quickly stop the plunger from turning as you work.

Once you have repositioned the Rubber Reverse Disc ¼" above the lower pulley, test the action of Reverse as illustrated at the end of "Replacing The Belt" in Photos 27 and 28.

Please remember whenever your tiller is in use in reverse the lever should return to Neutral when you let go! If it doesn't, raise the adjustment bolt until it does return to Neutral.

Your Reverse mechanism is simpler and easier to adjust than previous tillers, so you can fairly well ignore all of the instructions in the Owner's Manual about "Reverse Disc Alignment."

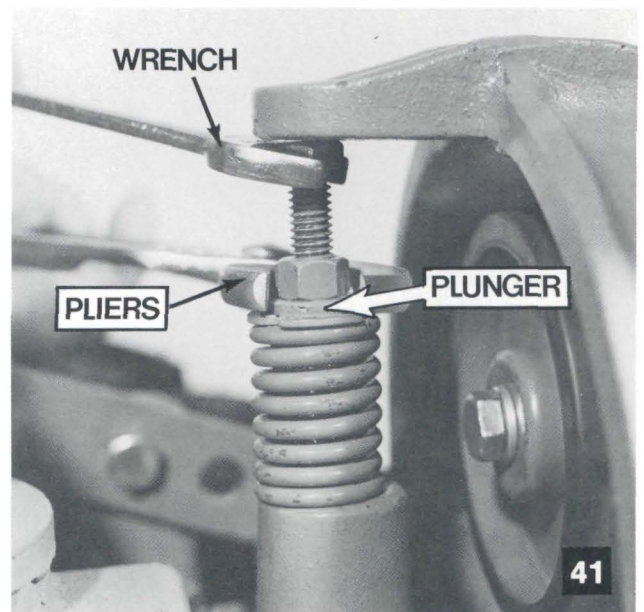
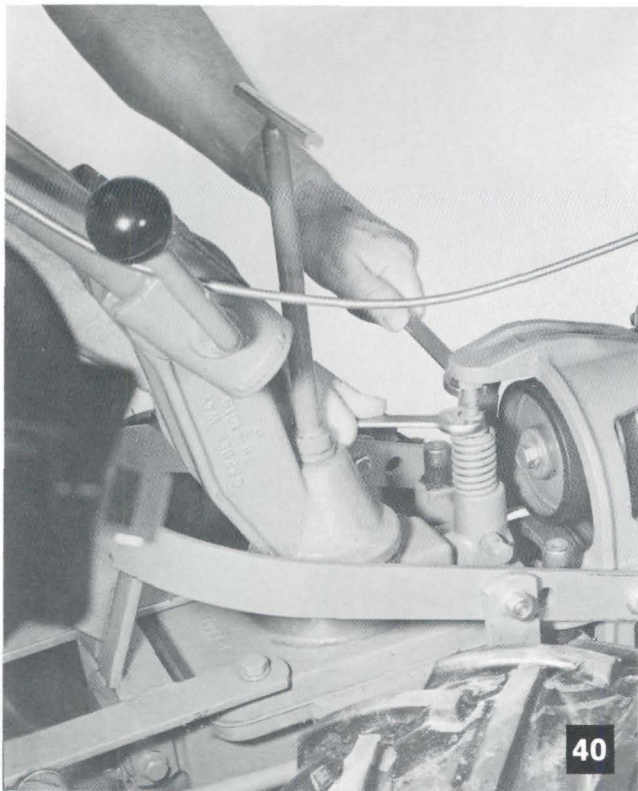

BELT ADJUSTMENT

Enclosed with this supplement is a sheet explaining when and how to adjust belts — the same information is already in your Owner's Manual in Section 7. However, we thought it might be helpful to you to know that a properly tightened belt should deflect inward ¼" with a modest push of 10 to 12 pounds with your finger.

SPECIAL NOTE ON USE OF THE DOZER BLADE WITH A FOUR SPEED TROY-BILT TILLER

If you are dozing snow and use High Range and Fast gear, it will move the tiller and dozer very powerfully and rapidly which could lead to accidental bumping of hard banks of snow, curbs or other solid objects. Such a bump at high speed can damage the wheel shaft or wheel gears. So, we recommend that you throttle back the engine to 60-70% power in HIGH RANGE, FAST SPEED while snow dozing or moving dirt.



Dozer blade moving snow



Banking snow

SPECIAL LUBRICATION INSTRUCTIONS FOR YOU

Your new Troy-Bilt Tiller has an advanced Forward/Reverse Lever and clutch yoke roller assembly. One of its fundamentals is to provide adequate force to hold the tiller in Forward while tilling, but come out of Forward drive whenever a positive movement of the lever upward is made by the operator. To keep these mechanisms operating properly and easily for you, it will require constant lubrication of all of the moving parts in the assembly: the clutch roller assembly including roll pins and rivets, the pivot points of the yoke, the vertical and horizontal links of the roller assembly, and the wheel speed shift lever. The belt adjustment block's face and the engine mounting bars require all-purpose grease.

Oil and grease these parts on a regular schedule and check to see that they work freely everytime you operate the tiller. You'll be amazed at how trouble-free a well lubricated tiller will stay for a long, long time.

For your benefit we have shown some photos here for you to see the general location of the lubrication points in Photos 44 and 45. Also, on the following pages there are closeup photos showing right where to squirt that oil can.

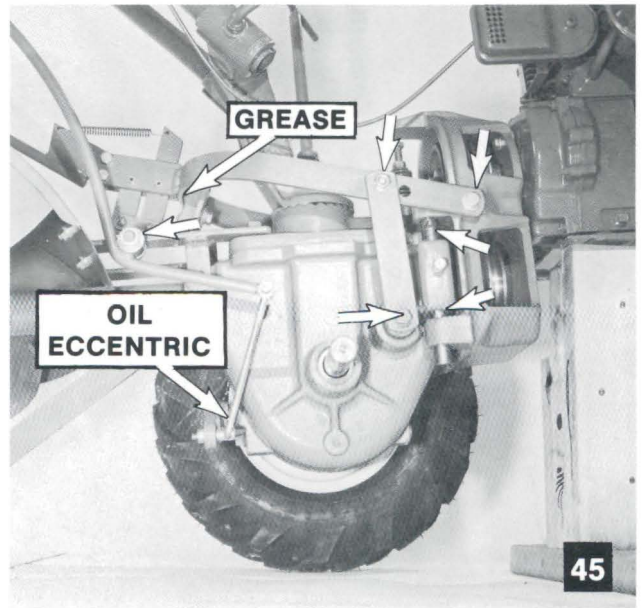
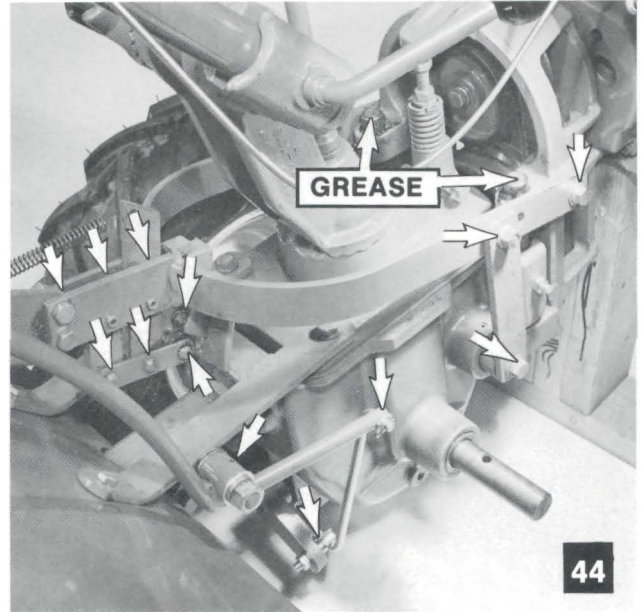

SQUIRT OIL AT ALL OF THESE SPOTS

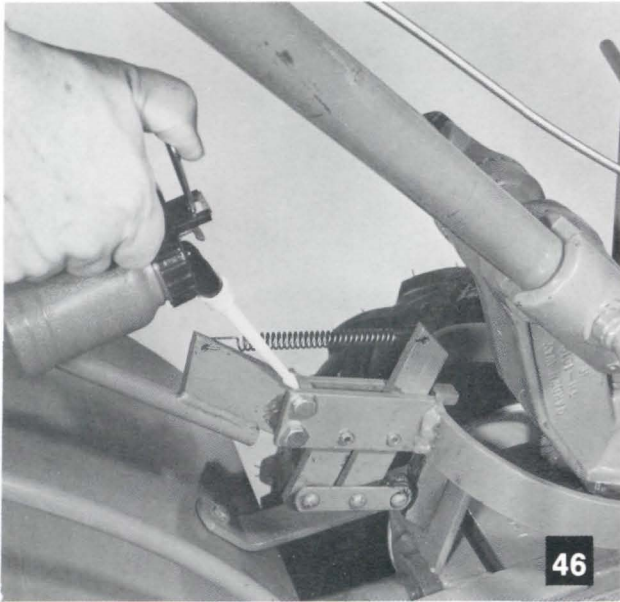

Oil bolts and plate

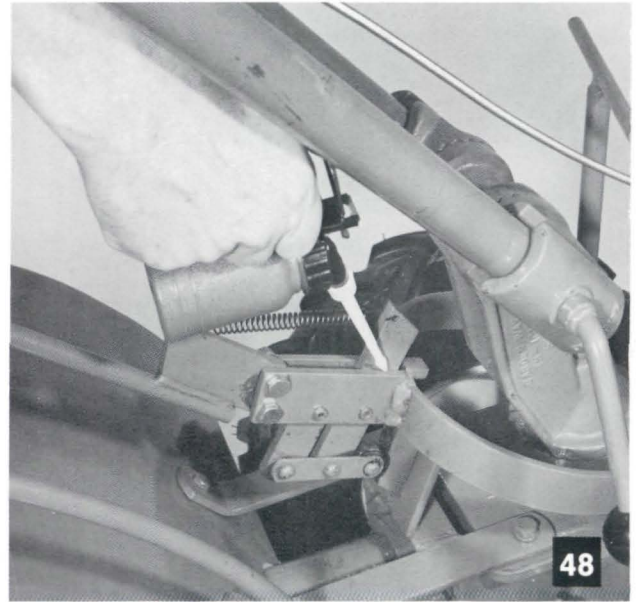

Oil link and rivets

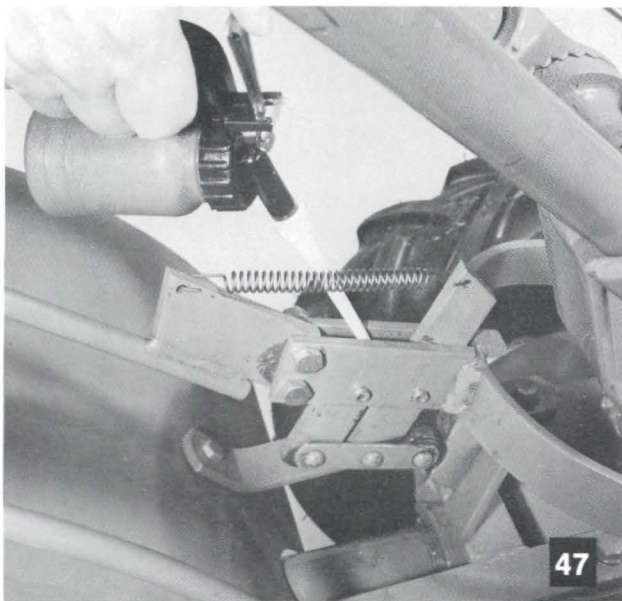

Let oil run down to roll pins

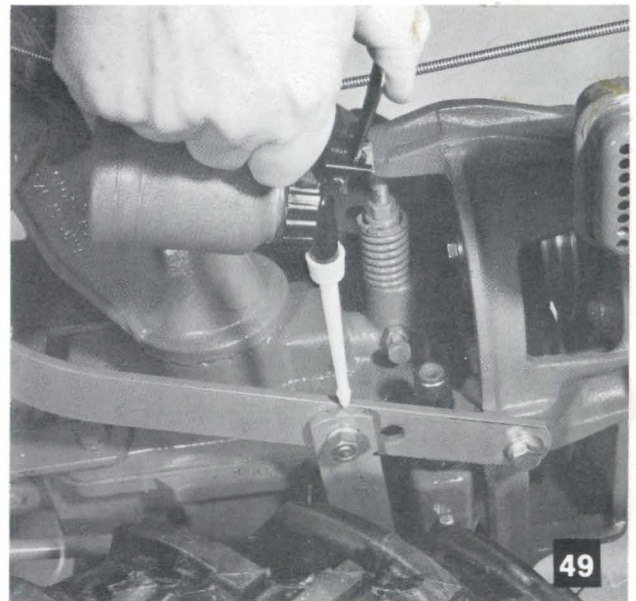

Top of vertical link

SQUIRT OIL AT THESE SPOTS TOO.

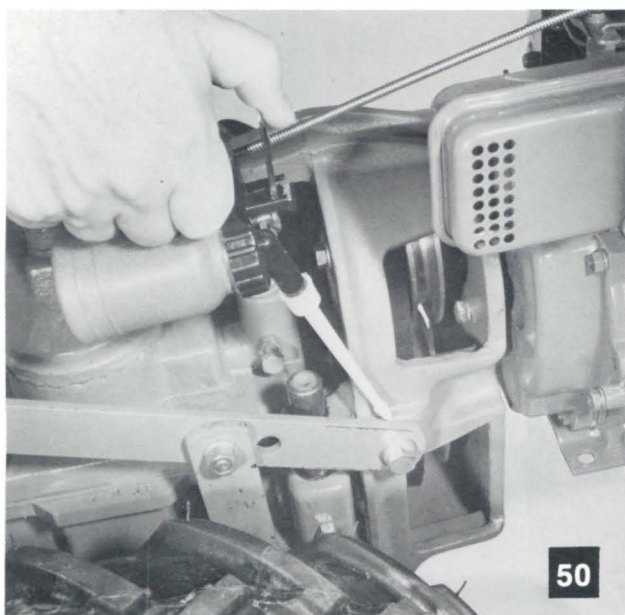

End of yoke and bolt

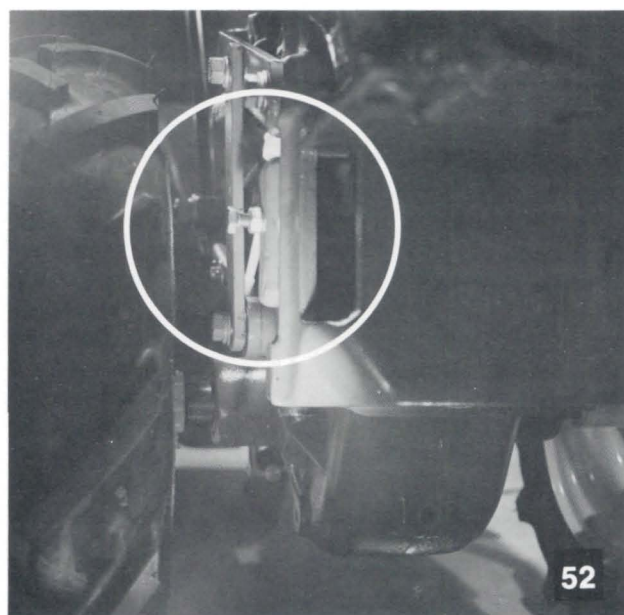

Bottom of Vertical Link

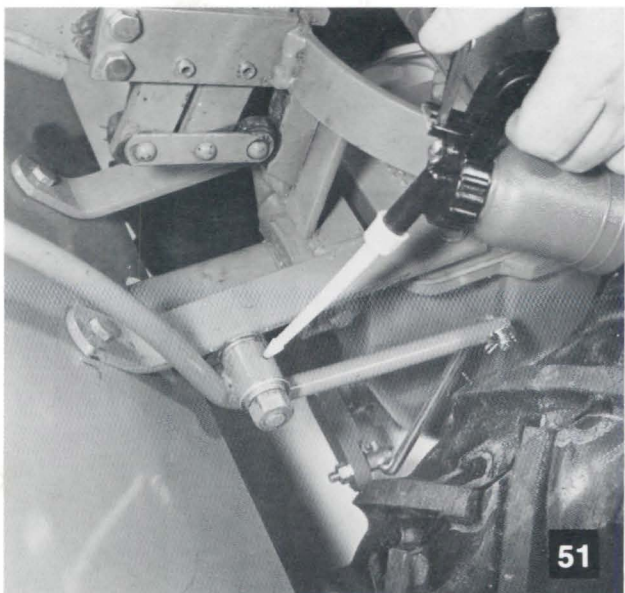

Pivot Point of Wheel Speed Shift Lever

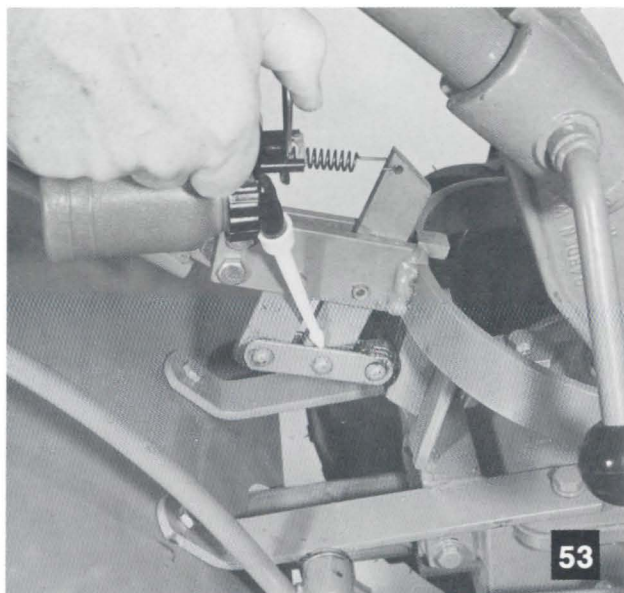

Rivets in Roller Assembly

A WORD ABOUT YOUR OWNER'S MANUAL

This supplement for your four-speed model simply updates the 176 page Owner's Manual that you received with this tiller. You can use your Owner's Manual and your Master Parts Catalog for all other information you need. Just keep in mind that you have a steel and rubber reverse disc, pulleys that use a single belt and have two operating positions and a few other parts in the yoke and clutch roller assembly that have been redesigned for your tiller. So, when you see things in the manual or catalog that refer to these areas, use the updated information that has been provided for you.

By the way, your Bolo Tines will probably be held in place with the new, easier-to-install mounting bolt instead of a stud, washers and a nut.

Let us know if you need any further information.

Thanks from the Product Information folks at Garden Way

CAUTION ABOUT GASOLINE

Please remember, when refueling your engine, to **WAIT UNTIL THE ENGINE AND MUFFLER ARE COOL BEFORE REFUELING.** Accidental spilling of gasoline on a hot engine or muffler can cause a fire or gasoline explosion. A corroded or broken muffler is much more likely to cause a spark or smoldering particle that could cause such a fire or explosion. Replace corroded mufflers whenever there is a hole in the muffler.



102nd Street & Ninth Avenue, Troy, N.Y. 12180

Tel. (518) 235-6010

BrentChalmers.com