

115m

PTO HORSE MODEL

TROY-BILT® Roto Tiller-Power Composter

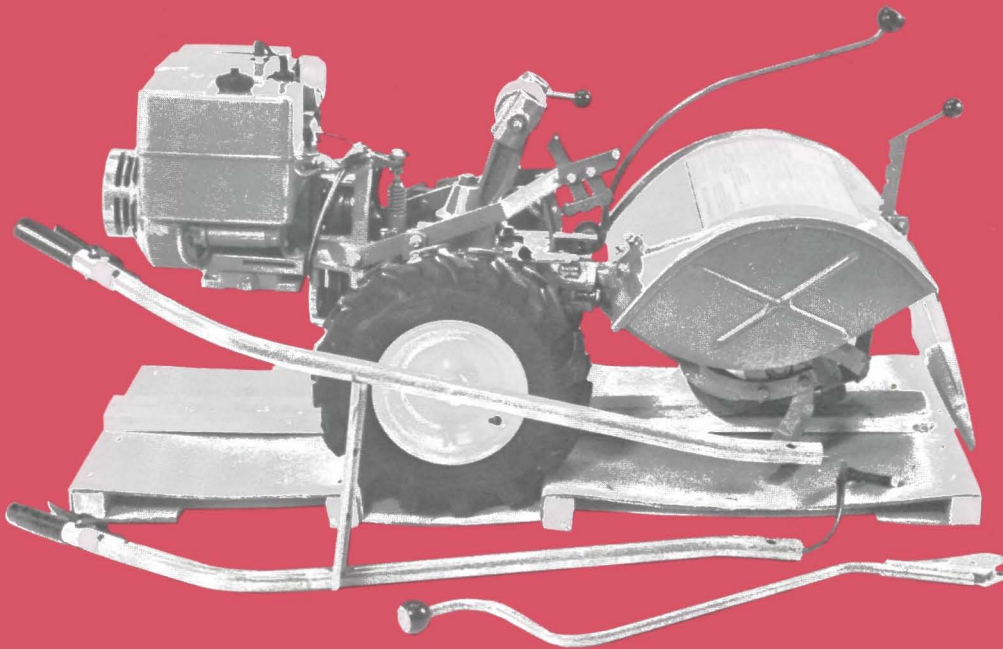

ASSEMBLY INSTRUCTIONS

A step-by-step guide to assembling your new tiller...
quickly and easily!

BrentChalmers.com

PRE-ASSEMBLY INSTRUCTIONS

- Before you begin to assemble your tiller, please read all of the step-by-step assembly instructions very carefully.

- If you have any problems or questions during the assembly steps, please contact our Technical Service Department at this TOLL-FREE number: 1-800-833-6990. (From Alaska call Collect: 518-235-6010, in Canada call Collect: 416-674-1502.)

- If you discover any damaged items or find parts are missing, call our Technical Service Department for replacements or for advice on filing a shipping damage claim.

- If you ordered any optional attachments, they have either been shipped inside the tiller container (room permitting), or in separate shipping cartons.

- All references to "Left" and "Right" are given from the operator's position behind the handlebars.

- To assemble your tiller you will need:

1. One (1) each of the following Open or Box End Wrenches (or an Adjustable Wrench): 3/8", 9/16" and 3/4"
2. Two (2) each of the following Open or Box End Wrenches (or

Adjustable Wrenches): 7/16" and 1/2"

3. Scissors (to trim plastic cable ties).
4. Tire Pressure Gauge.
5. A clean rag or paper towels.
6. A box, brick, or board(s) measuring 3-1/2" high.



WARNING

To avoid personal injury or damage to equipment, the tiller must be assembled carefully and exactly according to these assembly instructions.

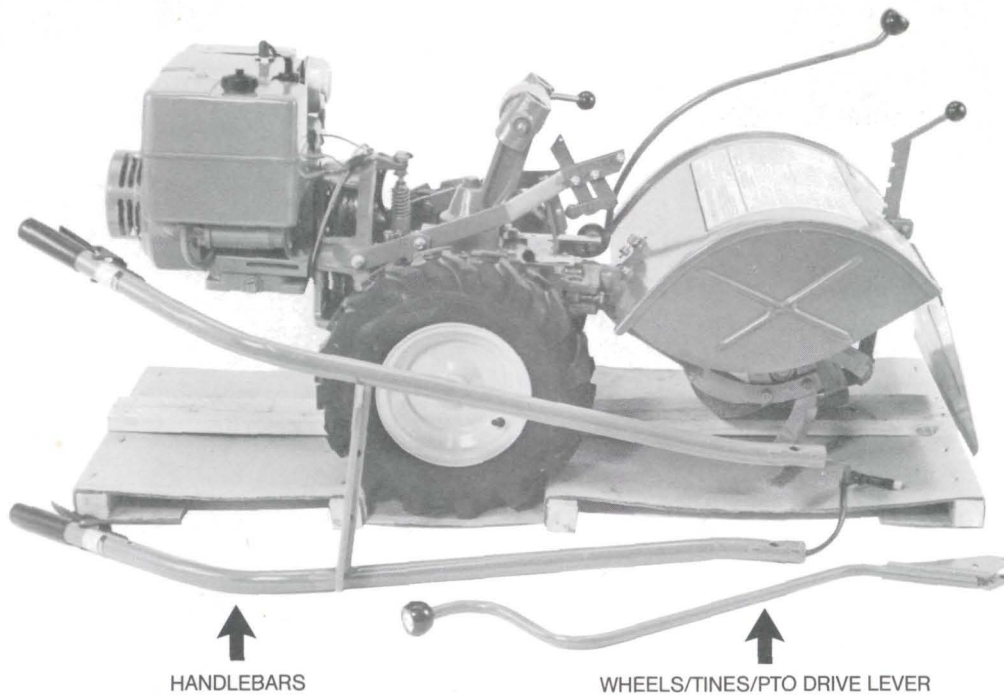

HANDLEBARS

WHEELS/TINES/PTO DRIVE LEVER

(Photo 1) Remove handlebars and Wheels/Tines/PTO Drive Lever.

STEP 1: Remove loose parts

If you haven't already done so, remove the following loose parts from the shipping container. If you are missing any items, please contact us immediately.

A. Remove the handlebars and

WARNING

To avoid personal injury, do not attempt to lift your tiller from its shipping platform. Follow these assembly steps, in sequence, for directions on how to safely remove your tiller from the platform.

the Wheels/Tines/PTO Drive Lever (Photo 1). Set the handlebars on a clean surface, being very careful not to allow dirt to get on the wire harness plug which is located at the bottom of the handlebars. Keep this plug clean at all times!

B. Remove the following loose items from the plastic envelope that contained these instructions (items are keyed to Photo 2):

1. One (1) Clutch Pawl Spring
2. One (1) Belt Adjusting Tool
3. Two (2) Plastic Cable Ties
4. One (1) Curved Head Bolt, 1/4"-20 x 2" (Grade 5)

5. One (1) Flanged Lock Nut, 1/4"-20

C. If you ordered an Electric Start Tiller, there will be a sealed hardware package in the literature envelope. The parts in that package are keyed to Photo 3:

1. One (1) Negative Battery Cable
2. Two (2) 5/16" Battery Terminal Nuts
3. Two (2) 3/4" long Battery Terminal Bolts
4. One (1) Plastic Venting Tube
5. One (1) Insulated Terminal Boot

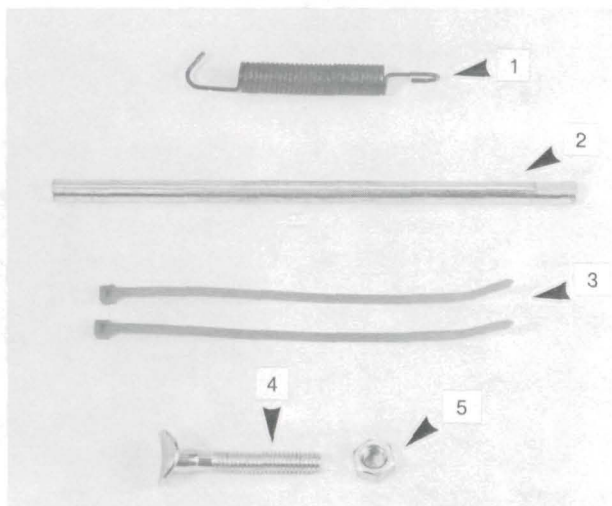

(Photo 2) These parts are inside literature envelope.

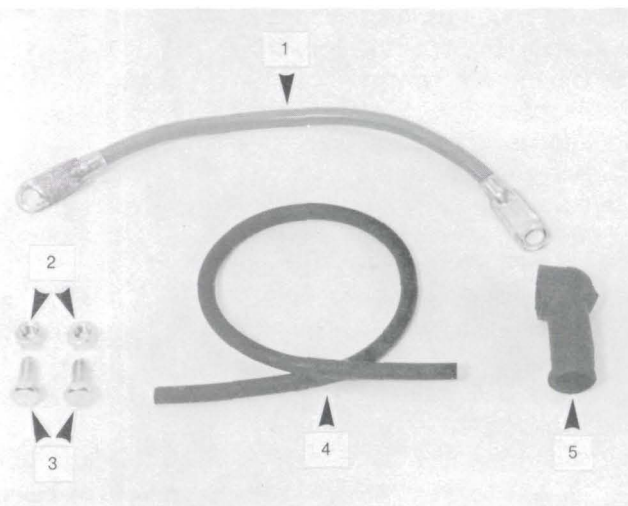

(Photo 3) Parts for Electric Start Tillers.

STEP 2: Attach the handlebars

Please attach the handlebars before you try to wheel the tiller off its shipping platform. With the handlebars attached, you'll be able to easily roll the wheels up and out of the wheel wells in the platform.

A. Slowly unwind the Handlebar Height Adjustment Lever in a counterclockwise direction (Photo 4). As you do, be prepared to catch the nut, clamp and ratchet on the left side of the handlebar base. Completely remove the lever, taking with it the clamp and ratchet on the right side of the handlebar base. Keep the left and right side clamps and ratchets separated from each other.

B. Position the lower ends of the handlebars on either side of the handlebar base. The wire harness at the bottom of the handlebars should be located to the rear of the handlebar base (Photo 5).

C. Place the right side ratchet on the inside edge of the right side handlebar (with teeth on ratchet facing teeth on handlebar base), and place the right side clamp on the outside. Insert the lever through the clamp, handlebar, ratchet and handlebar base until the end of the lever just starts to protrude through the left side of the base (Photo 6). NOTE: The lever should pass freely through the holes in each handlebar. If it doesn't, do not attempt to force it through as the holes may be blocked by either the Forward Interlock Safety System wires or by their plastic positioning plugs. If blocked, use a pencil or a screwdriver to gently push the wires or plugs out of the way.

D. Push the left side handlebar away from the handlebar base and place the left side ratchet on the inside of the handlebar (with teeth on ratchet facing teeth on handlebar base). See Photo 7.

E. Install the nut in the left side clamp and hold the clamp against the handlebar. Then turn the lever in a clockwise direction until it

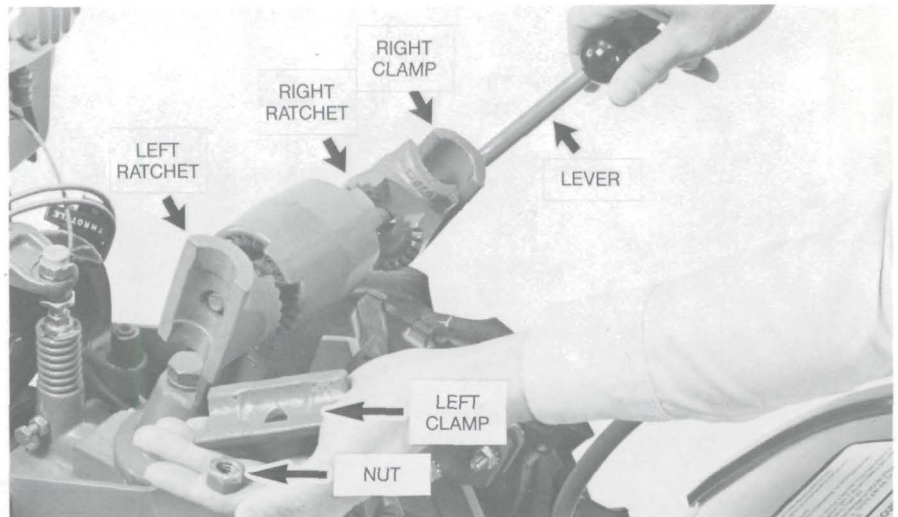

(Photo 4) Remove lever, nut, clamps and ratchets.

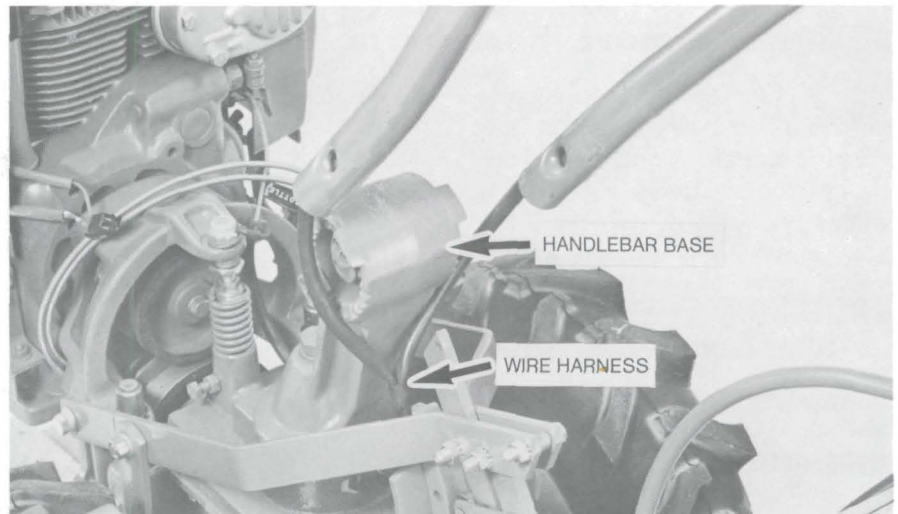

(Photo 5) Route wire harness to rear of handlebar base.

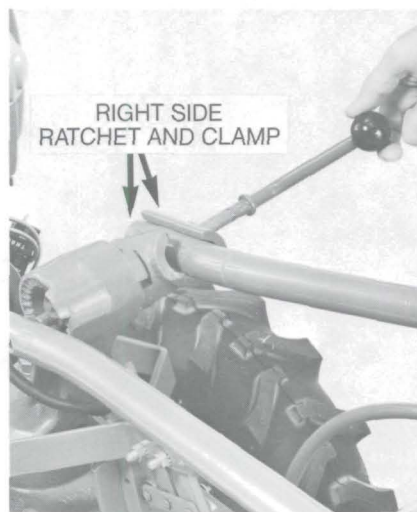

(Photo 6) Install right side ratchet and clamp and insert lever.

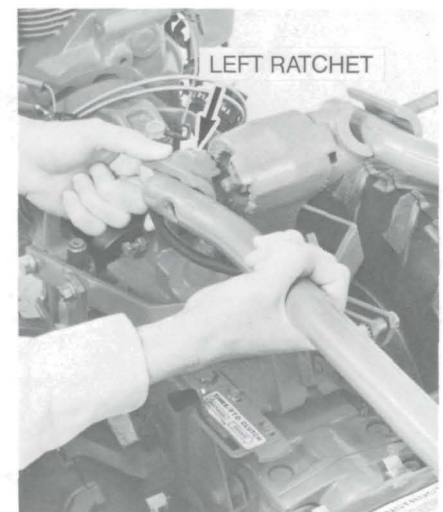

(Photo 7) Install left side ratchet.

threads into the nut several turns (Photo 8).

F. Raise the handlebars to either of two preset height settings and tighten the lever securely. While tightening, you may have to jiggle the ratchets a little to help align the teeth on the ratchets with the teeth on the handlebar base.

NOTE: The wire harness plug at the bottom of the handlebars will be connected in Step 4.

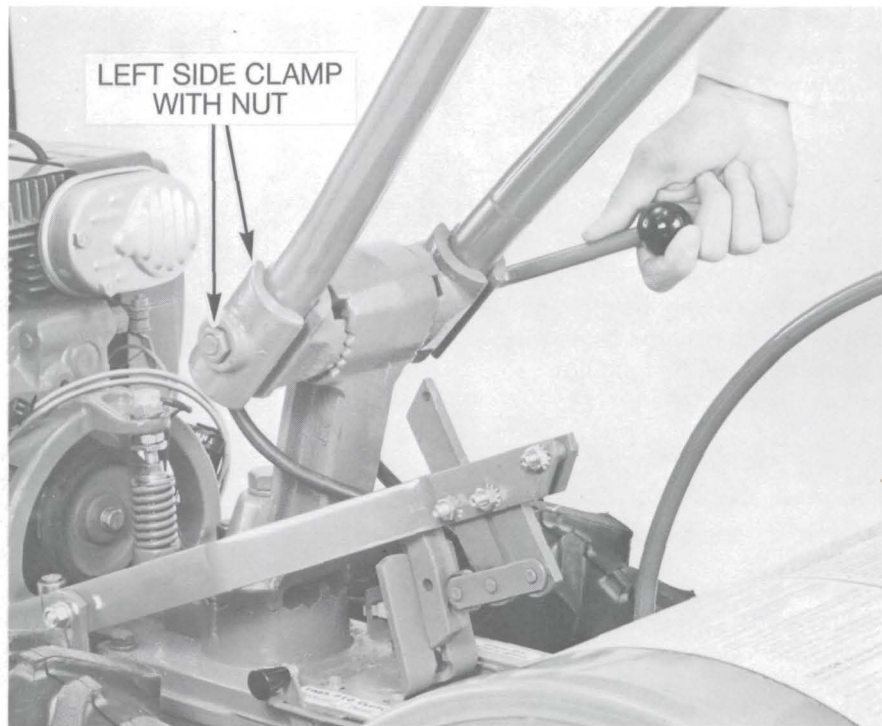

(Photo 8) Add left side clamp (with nut) and thread lever into nut.

STEP 3: Remove the tiller from its shipping platform

A. The Depth Regulator Lever (shown in Photo 9) may be secured to its mounting bracket with a plastic tie strap. To check, lift the hinged flap on the end of the hood and look for a tie strap that encircles the notched drag bar. Snip off the tie strap with scissors.

B. Lift the handlebars until the tines are clear of the shipping platform. Then, in one steady motion, pull the handlebars back and to one side, until one wheel rolls up and out of its wheel well (Photo 9).

NOTE: If the wheels won't turn, move the Wheel Speed Lever (shown in Photo 9) a short distance up or down to take the wheels out of gear.

C. You should now roll the tiller to a level area where you can complete the assembly steps.

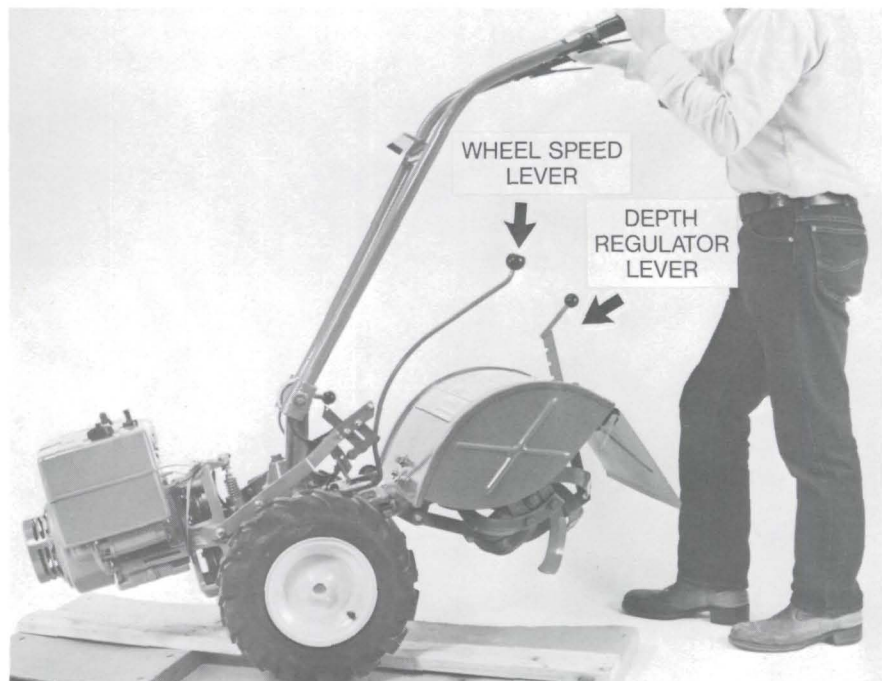

(Photo 9) Lift handlebars and then pull to one side. If needed, move Wheel Speed Lever up or down to take wheels out of gear.

STEP 4: Connect the Forward Interlock Wire Harness

A. The plug on the wire harness that leads from the lower ends of the handlebars must be plugged into the wire harness receptacle located on the top, right side of the transmission (Photo 10). This connection completes the wiring circuit for the Forward Interlock Safety System on your tiller. If the wire harness is not connected, your tiller will not operate properly.

B. Before attaching the plug, make certain that all of its surfaces are clean. Then seat the plug firmly into the receptacle.

WARNING

To avoid personal injury, test the Forward Interlock Safety System prior to each use of the tiller to make certain the system is functioning. See Section 3 of your PTO HORSE Model Owner/Operator Manual for the testing procedure to follow.

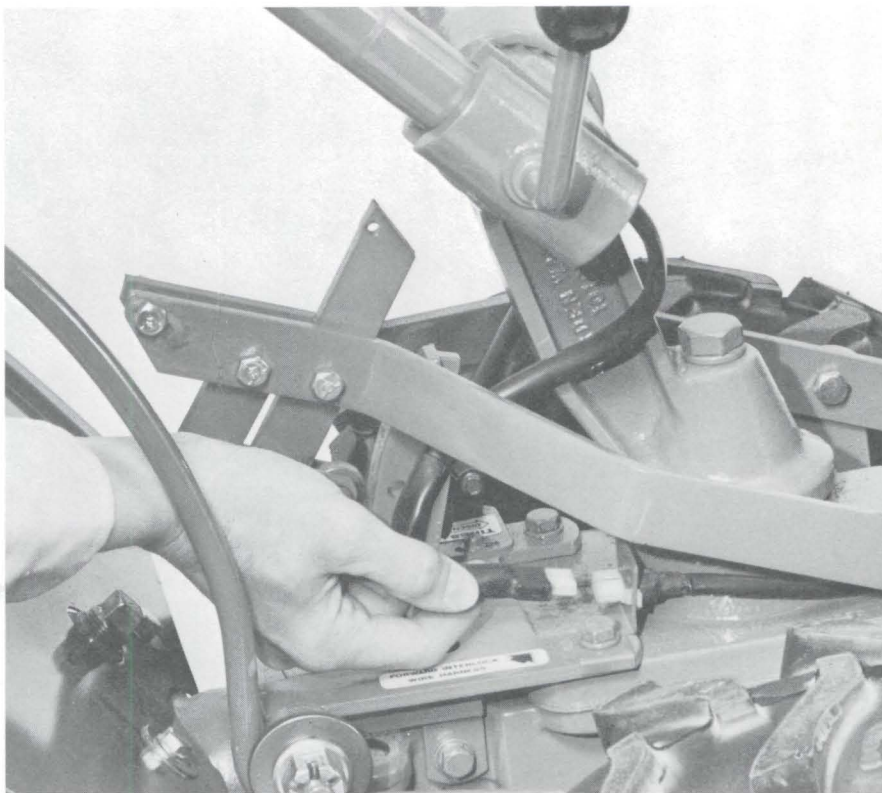

(Photo 10) Connect wire harness plug to receptacle.

STEP 5: Attach the Wheels/Tines/PTO Drive Lever

The Wheels/Tines/PTO Drive Lever is shown in Photo 1 on page 1. To attach the lever, you will need the clutch pawl spring that is

shown in Photo 2 on page 1.

A. Before attaching the lever, use a 3/4" wrench to loosen (do not remove) the bolt in the top of the

handlebar base. See Photo 11.

Then swing the handlebars over to the right side of the tiller.

B. Using two 1/2" wrenches, remove the nut, star washer, bushing and bolt from the hole closest to the rear of the clutch yoke assembly plates (Photo 12). Set these parts aside.

C. Using the same wrenches, remove and set aside the nut, star washer and bolt that secures the short vertical link to the center of the yoke (Photo 13). The short link (with bushing inside link) should remain in position when the bolt is removed. If it drops down, be sure to replace it inside the yoke before attaching the lever.

D. Slide the plates on the end of the lever over the yoke and align the upper hole in the plates with the hole at the rear of the yoke (Photo 14). Insert the bushing (removed in Step B) inside the yoke and install the bolt through



(Photo 11) Loosen bolt and swing handlebars to right side.

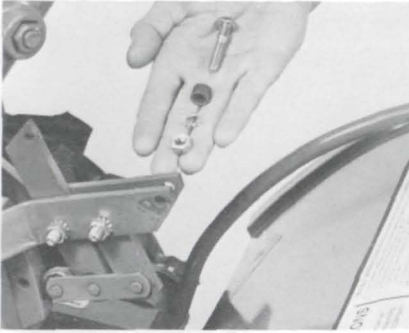

(Photo 12) Remove hardware from rear of yoke plates.

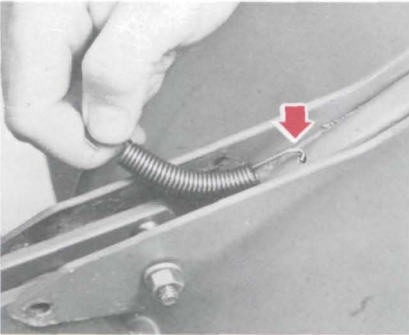

(Photo 15) Widest hook on spring goes into lever.

the plates, bushing and yoke. (If necessary, gently tap the head of the bolt with a hammer, being careful not to damage the threads on the bolt.) Add the star washer and nut and tighten the nut finger-tight.

E. Look at the hooks on the ends of your clutch pawl spring. One hook has a wider (45° angle) opening than the other. Insert the hook with the widest opening down into the small hole in the lever, pushing the hook in as far as it will go (Photo 15).

F. Tilt the lever forward as far as you can and insert the other hook on the spring all the way through the hole in the top of the tall vertical link (Photo 16). If necessary, use a pair of long-nosed pliers to help insert the hook (be careful not to bend or damage the hook with the pliers).

G. Pull the lever back down and install the bolt that you removed in Step C through the remaining holes in the lever, yoke and short vertical link. Add the star washer and nut and tighten the bolt and nut securely (Photo 17).

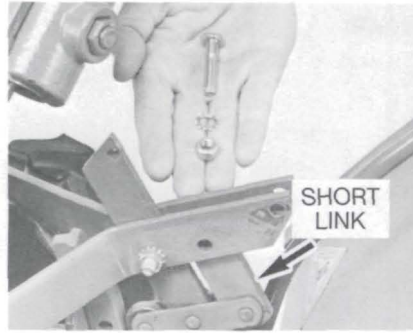

(Photo 13) Remove hardware that secures short link to yoke plates.

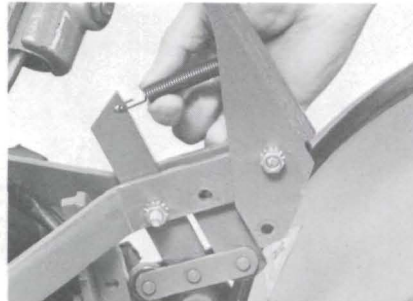

(Photo 16) Tilt lever forward and attach hook through tall vertical link.

H. Securely tighten the bolt and nut that you finger-tightened in Step D.

I. Swing the handlebars back to their normal operating position and securely tighten the mounting bolt in the handlebar base.

J. Test the operation of the lever by first pushing it all the way down until it is engaged in the "FORWARD" position. The clutch roller on the end of the shifting linkage assembly should be engaged beneath the belt adjustment block (Photo 18). Next, return the lever to the "NEUTRAL" position by lifting or tapping the lever upward and letting it go. The clutch roller should now be resting on the face of the adjustment block (Photo 19). It should not take too great an effort to release the roller from beneath the adjustment block. Finally, lift the lever all the way up to the "REVERSE" position and then let it go. It should automatically spring back to its "NEUTRAL" position. If the lever does not function as described above, do not attempt to operate the machine. Call our Technical Service Department for adjustment instructions.

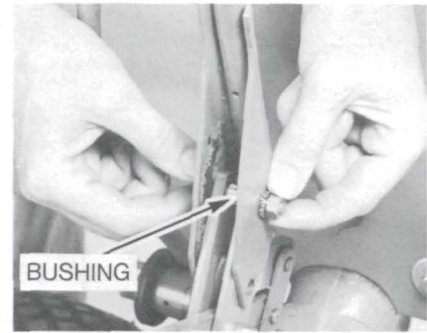

(Photo 14) Insert bushing and install bolt through upper hole in lever and yoke plates. Loosely add star washer and hex nut.

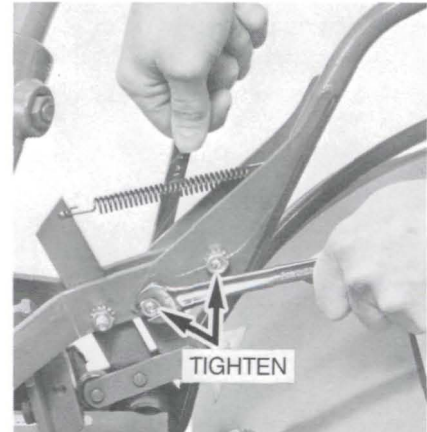

(Photo 17) Install bolt through lever, yoke plates and short vertical link.

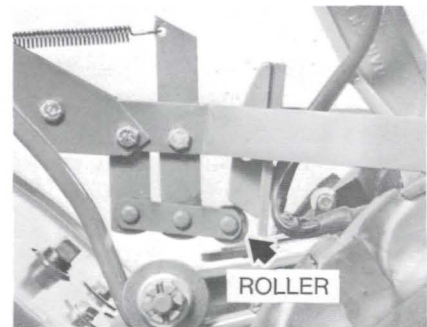

(Photo 18) With lever in "FORWARD" position, clutch roller should be engaged beneath adjustment block.

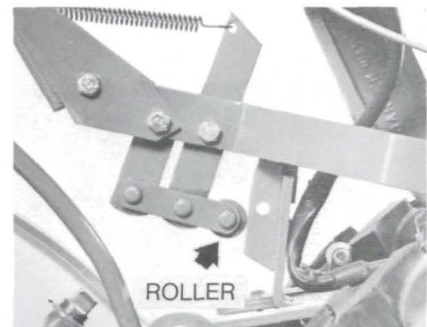

(Photo 19) With lever in "NEUTRAL" position, clutch roller should be on face of adjustment block.

STEP 6: Check the gear oil levels in the Power Unit and Tine Attachment transmissions

Your tiller has two separate transmissions, one for the Power Unit and one for the Tine Attachment. We have installed SAE #140 weight GEAR OIL in both transmissions here at the factory. However, you should make these very important checks to be sure that your oil levels are still correct. You should have a clean rag or paper towel available before you begin.

TO CHECK THE POWER UNIT TRANSMISSION:

- A.** Make sure your tiller is on level ground.
- B.** Pull the Depth Regulator Lever back and then pull it up until the tines are resting on the ground (Photo 20).
- C.** Using a 3/8" wrench, remove the oil level check plug located above the wheel shaft on the left side of the transmission (Photo 21). Due to dried paint on the plug threads, it may require some force to loosen the plug for the first time.
- D.** If the gear oil level is correct, oil should start to seep out of the hole (in cold weather the gear oil will flow very slowly, so be patient). If it does, your check is finished and you should reinstall the plug, tightening it securely.

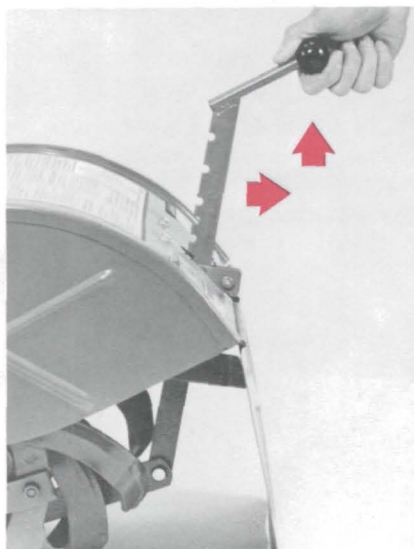

(Photo 20) Pull Depth Regulator Lever back and then up.

E. If oil does not seep out of the hole, you should check the oil level further by tilting the machine slightly toward the hole (roll the right side wheel onto a 1" thick board). If oil now seeps out of the hole, it indicates that only a small amount of oil needs to be added. However, if there is still no sign of oil, then the oil level may be dangerously low. In either situation, be sure to add the correct amount of oil before operating the tiller. For instructions on how to do this, please refer to "Adding or Changing Gear Oil" in Section 6 of your PTO HORSE Model Owner/Operator Manual.

NOTE: Remove board beneath right wheel before adding gear oil.

TO CHECK THE TINE ATTACHMENT TRANSMISSION:

- A.** Make sure your tiller is on level ground.
- B.** Pull the Depth Regulator Lever back and then push it all the way down until it is engaged in its highest notch. The tines should now be off the ground and the tiller should be resting on the drag bar located in the center of the tines.
- C.** Prop up the drag bar until the

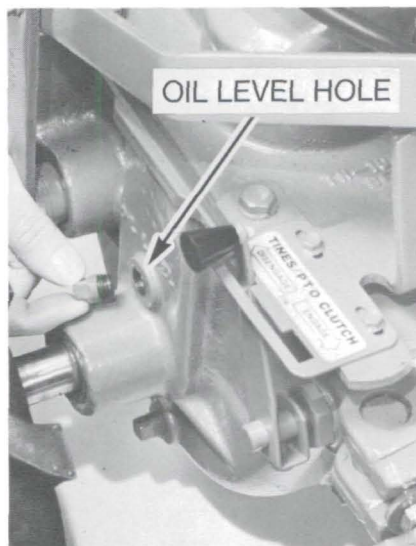

(Photo 21) Gear oil should seep from oil level check hole.

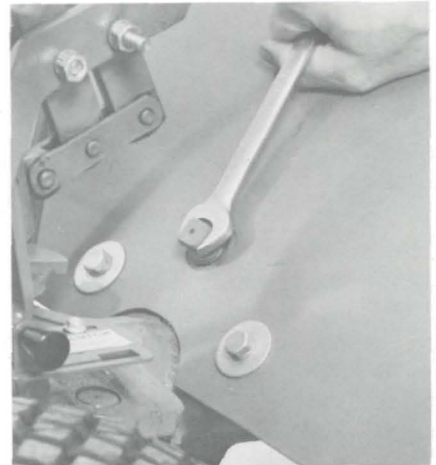

(Photo 22) Remove oil level dipstick.

bottom of the bar is raised approximately 3-1/2" off the ground.

D. Allow the tiller to rest in this position for at least two minutes (or much longer if the air temperature is below 40°F).

E. Using a 9/16" wrench, remove the oil level dipstick as shown in Photo 22. Wipe the dipstick with a clean rag and note the "HOT" and "COLD" range markings on one side of the dipstick (Figure 23).

F. Hold the dipstick so that the markings face to the rear of the tiller. Then gently lower the dipstick straight down into the sump hole until the end just touches the drive shaft inside the hole (Photo 24). Do not force, or try to thread the dipstick into the hole. Doing so will bend the dipstick and result in an incorrect oil level reading.

G. After waiting a few seconds, carefully remove the dipstick and look at the markings. The oil level is correct if there is oil showing anywhere within, or above, the "COLD" range marking. If correct, your check is finished and you should securely replace the dipstick. You should then remove the prop from beneath the drag bar.

H. If there is no oil showing on the dipstick, then you must add the correct amount of oil before operating the tiller. For instructions on how to do this, please refer to "Adding or Changing Gear Oil" in

Section 6 of your PTO HORSE Model/Owner Operator Manual.
NOTE: Remove prop beneath drag bar before adding gear oil.

IMPORTANT

Check the gear oil levels after the first 2 hours of new tiller operation and after every 30 operating hours thereafter. See "Transmission Gear Oil Maintenance" in Section 6 of your PTO HORSE Model Owner/Operator Manual for detailed instructions.

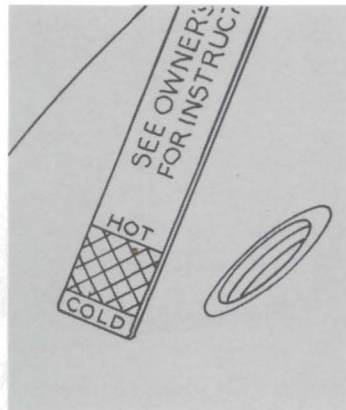

(Figure 23) Note "HOT" and "COLD" markings on dipstick.

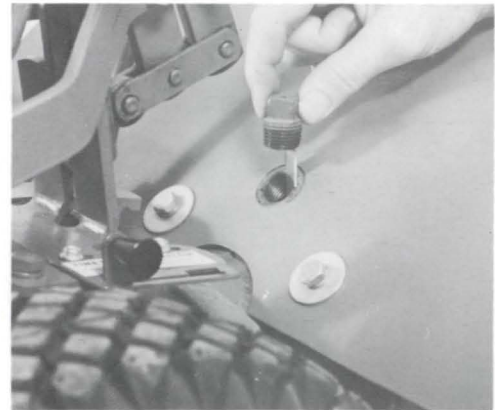

(Photo 24) Insert dipstick with markings facing to rear of tiller.

STEP 7: Check the oil level in the engine

Your engine's crankcase was filled at the factory with SAE #30, SF classified motor oil. However, you should check the oil level now, to be certain that it is still up to the "FULL" mark on the engine dipstick. Have a clean rag or paper towel available before you begin.

- A.** Make sure your tiller is on level ground.
- B.** Move the Depth Regulator Lever back and then all the way down until it engages the top notch in the lever. This places the base of the engine at a slight angle. Always slope the engine in this manner when checking the oil level, as your dipstick has been specially calibrated to account for this angle.
- C.** Clean the area around the dip-

stick so that debris will not fall into the crankcase when the dipstick is removed.

- D.** Remove the dipstick and wipe it with a clean rag (see Photo 25 or 26). Then reinstall the dipstick. NOTE: On the 7 HP Tecumseh engine the dipstick should be screwed in until tight. On the 8 HP Kohler engine, it should be firmly pushed down until it "snaps" into place.
- E.** Remove the dipstick and read the scale at the end of the dipstick. The oil level should be up to, but not over, the "FULL" mark.
- F.** If you need to add oil, place a clean funnel in the dipstick hole and add SAE #30 weight oil that has an API service classification of

"SF". Add the oil a little at a time, checking the level frequently with the dipstick until the oil level is at the "FULL" mark. Be careful not to overfill the engine.

- G.** Replace the dipstick securely.

IMPORTANT

Change the oil after the first 2 hours of new operation and every 10 operating hours thereafter, or more often if operated in extremely dusty or dirty conditions. See "Engine Oil Maintenance" in Section 6 of your PTO HORSE Model Owner/Operator Manual for detailed instructions.

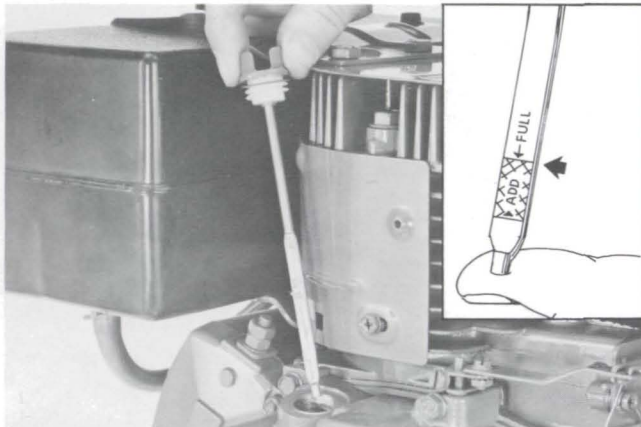

(Photo 25) Remove 7HP Tecumseh engine dipstick.

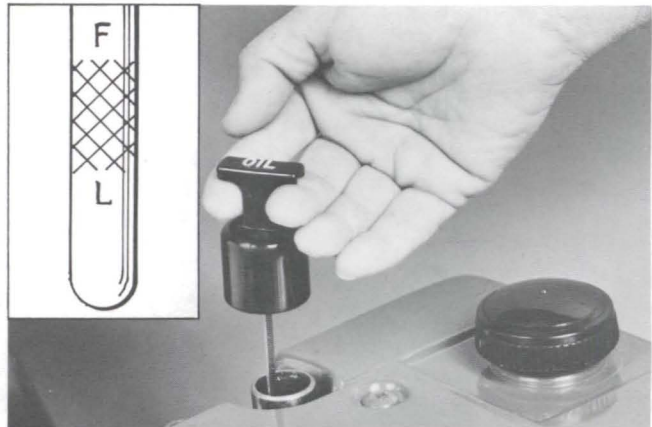

(Photo 26) Remove 8HP Kohler engine dipstick.

STEP 8: Attach the Engine Throttle Lever

The throttle cable and its lever is wrapped around the engine for shipping purposes. Carefully unwrap the cable and then install it as follows.

NOTE TO 7 HP TECUMSEH ENGINE OWNERS: If you purchased and received an optional Wrap-Around Bumper/Guard with your new tiller, you should install it before you attach the throttle cable. Refer to the installation instructions that came with the bumper.

A. Locate the Curved Head Bolt, Flanged Lock Nut, and two Plastic Ties that are shown in Photo 2 on page 1.

B. Place the throttle cable along the inside edge of the right handlebar and position the control lever as shown in Photo 27.

C. Insert the bolt through the outside edge of the handlebar and into the hole in the center of the control lever mounting bracket. Add the nut and tighten it securely with a 1/2" wrench.

D. Secure the cable to the handlebar with the two plastic ties (Photo 28). Put the serrated side of the tie on the inside loop and pull the tie tight. Snip off the ends of the ties with scissors, being careful not to leave any sharp, protruding ends.

WARNING

On electric start tillers, make sure that the throttle cable does not touch any portion of the battery. Doing so could cause a short circuit that could damage the battery and the cable. To prevent a short circuit, always route the cable below the battery, keeping it on the outside of the right side battery bracket support leg.

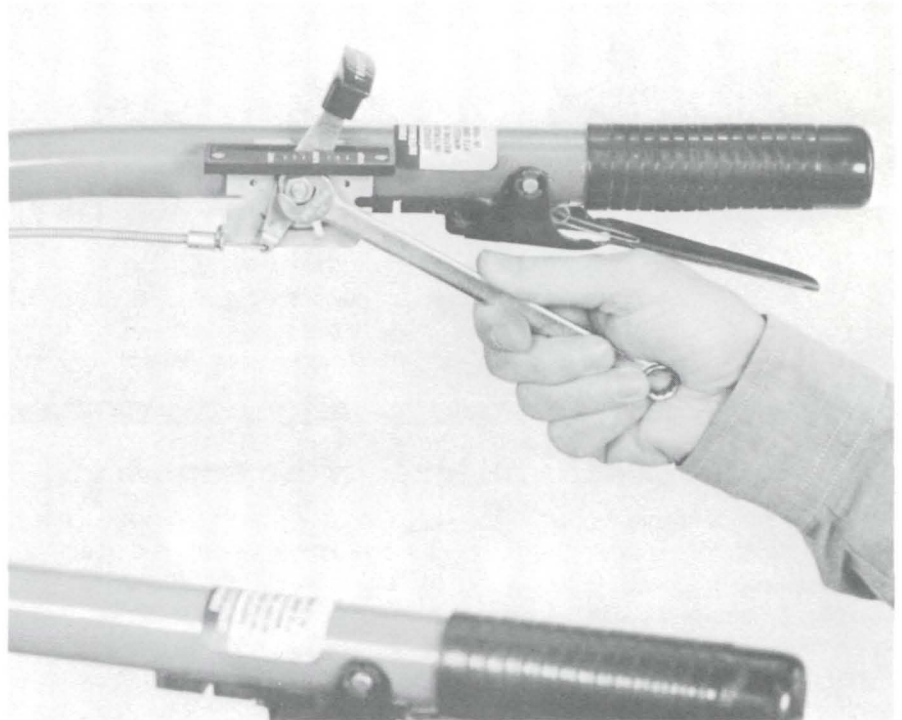

(Photo 27) Attach throttle control to right side handlebar.

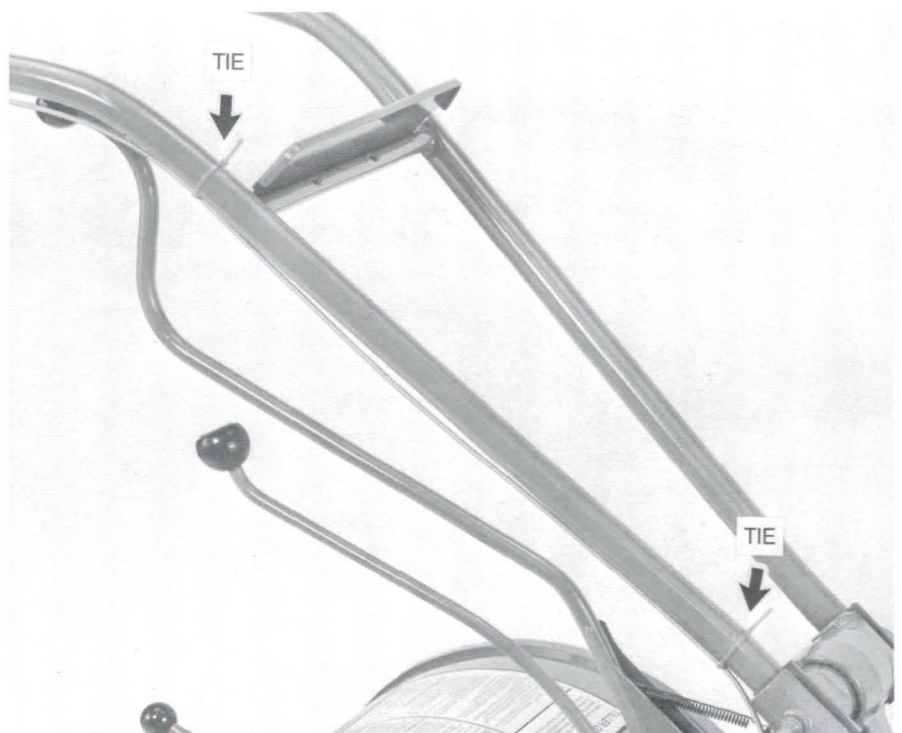

(Photo 28) Secure cable with plastic ties.

STEP 9: Adjust the air pressure in the tires

A. For shipping purposes only, the tires have been inflated above the recommended range for tilling.

B. Before using your tiller, check the air pressure in each tire (Photo 29). The pressure should be adjusted to 10 to 20 psi (pounds per square inch).

C. Be sure that both tires have the same air pressure. If the pressures are not equal, the tiller will pull to one side when you are moving it.

IMPORTANT

If you have a recoil starting tiller, it is now completely assembled. If you have an Electric Start Tiller, please continue with the following electric start assembly steps.

WARNING

To avoid personal injury or damage to equipment, do not attempt to operate the tiller or its engine until you have read and thoroughly understand all of the Safety, Controls, and Operating Instructions in the separate PTO HORSE Model Owner/Operator Manual.

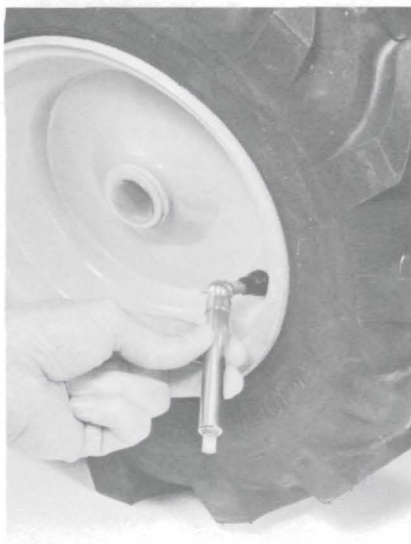

(Photo 29) Check air pressure in each tire.

ASSEMBLING THE ELECTRIC START SYSTEM

The following steps explain how to activate, charge and install your new battery. For your safety, follow each step carefully and observe all of the accompanying Safety Messages.

For future battery maintenance,

including battery recharging instructions, please refer to the "Battery Care and Maintenance" information in Section 6 of your PTO HORSE Model Owner/Operator Manual.

STEP 1: Activating and charging the battery

IMPORTANT

Your new battery was shipped to you "dry". You must have battery electrolyte (battery grade sulfuric acid) added to it. Then you must have the battery fully charged before placing it in service.

Adding electrolyte to the battery and charging the battery can be dangerous work. The acid in the electrolyte can cause severe burns or blind you. Also, a battery that is being charged produces explosive gases.

We strongly recommend that you take the battery to a TROY-BILT® Tiller dealer or to a reliable service station, battery store, or farm equipment center where a trained battery technician can complete the job safely.

PLEASE DO NOT ATTEMPT TO ACTIVATE THE BATTERY YOURSELF UNLESS YOU ARE FULLY EXPERIENCED IN BATTERY ACTIVATION AND CHARGING PROCEDURES!

To ensure that your battery is properly activated and charged, you should review the following instructions with your battery technician.

DANGER

POISON—CAUSES SEVERE BURNS

- Electrolyte is a sulfuric acid solution.
- Avoid contact with skin, eyes and clothing.
- To prevent accidents, wear protective clothing, rubber gloves, and shield eyes with safety goggles.
- Neutralize acid spills with a baking soda and water solution. Neutralize empty container with baking soda and rinse with water.

ANTIDOTE: External—Flush with water. Eyes—Flush with water for 15 minutes and get prompt medical attention.

ANTIDOTE: Internal—Drink large quantities of water or milk. Follow with milk of magnesia, beaten eggs, or vegetable oil. Call physician immediately.

KEEP OUT OF REACH OF CHILDREN

DANGER

BATTERIES PRODUCE EXPLOSIVE GASES

- Keep sparks, flames, cigarettes away.
- Ventilate area when charging or using battery in an enclosed space.
- Make sure venting path of battery is always open once battery is filled with acid.

TO ACTIVATE THE BATTERY:

A. For shipping purposes only, the battery was installed on the tiller at the factory. To remove the battery for activation and charging, use a 7/16" wrench to remove the two 1-1/2" long carriage bolts, 1/4" lockwashers, and 1/4" hex nuts that secure the front and rear legs of the hold-down clamp to the base of the battery bracket (Photo 30). Next lift the clamp off the battery and remove the battery. **NOTE:** The battery and the hold-down clamp were installed backwards at the factory to protect the key switch during shipment to you. The correct position for installing the battery and hold-down clamp will be shown in Step 3 of these instructions.

B. There may be a short length of sealed plastic tubing covering the vent fitting on the negative (-) side of the battery. (See Photo 30). Remove and discard this tube before activating the battery.

C. Place the battery on a level surface, safely away from any spark or flame-producing sources such as stoves, hot water and

WARNING

Remove metal jewelry before working near the battery or any part of the electrical system. Failure to do so can cause a short circuit that could result in electrical burns, an electrical shock, or an explosion of battery gases.

space heaters, clothes dryers, electric motors, furnaces, etc.

D. Remove the six filler caps on the top of the battery. Leave the caps off while activating and charging the battery.

E. Carefully fill each cell with battery grade electrolyte (1.265 specific gravity sulfuric acid) until the level just touches the lowest part of each filler well (Figure 31). The temperature of the battery and the electrolyte should be between 60°F and 80°F for best results. **DO NOT ADD WATER OR ANY OTHER LIQUID TO THE BATTERY DURING THIS INITIAL ACTIVATION.**

F. Allow the battery to stand for 30 minutes. Then check the electro-

lyte level in each cell. If needed, add more electrolyte until it reaches the lowest part of each filler well. Do not overfill the battery as this could lead to flooding from the cells when the battery is being charged.

G. Charge the battery as described next.

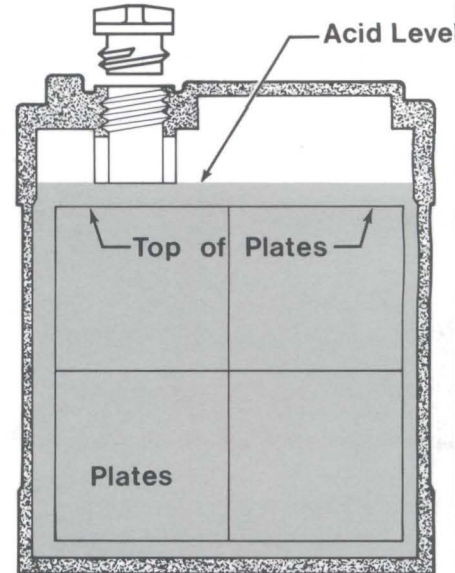

(Figure 31) Correct electrolyte level.

TO CHARGE THE BATTERY:

A. To obtain maximum starting capacity and longest battery life, charge the battery by one of the following methods until all of the cells are gassing freely. A battery is gassing freely when the surface of the liquid electrolyte is covered with tiny bubbles. To determine this, wear safety goggles and use a flashlight to look into each cell while the battery is being charged.

DANGER

When checking the battery for gassing, always wear safety goggles to look down into the cells. Failure to do so could result in severe personal injury from sulfuric acid.

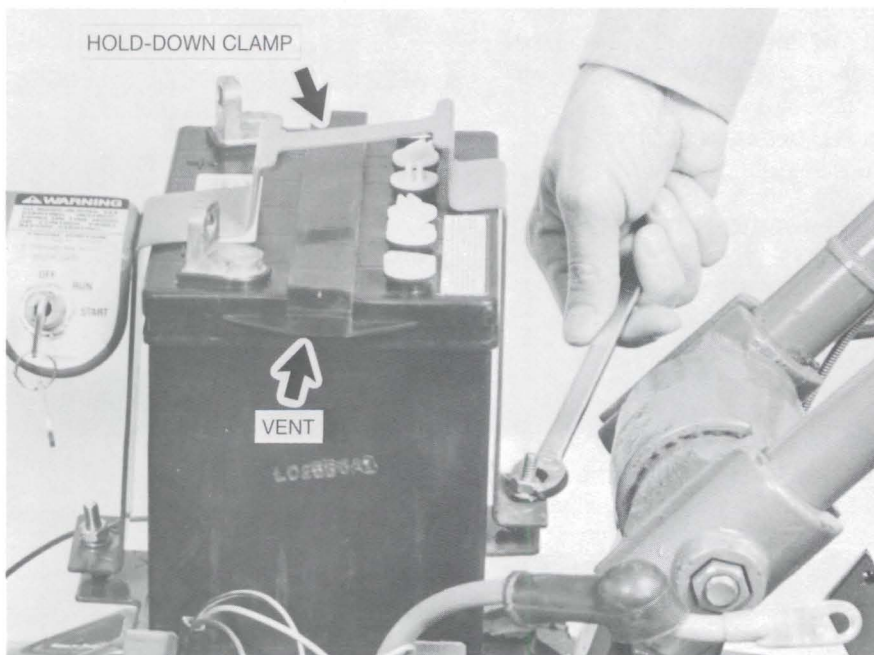

(Photo 30) Remove hold-down clamp and battery. Look for a sealed tube on the vent fitting and remove tube if so equipped.

! DANGER

TO AVOID PERSONAL INJURY OR PROPERTY DAMAGE:

- Batteries generate explosive gases. Keep sparks and flames away from the battery at all times.
- Ventilate area when charging or using battery in an enclosed space.
- Do not leave the battery unattended while it is being charged. The total charging time does not need to be continuous.
- Carefully follow the instructions and safety rules provided by the manufacturer of the battery charging equipment being used.
- Do not charge the battery at a rate higher than 12 amperes. Higher amperages can generate excessive heat and gassing, causing permanent damage to the battery.
- Never attempt to “jump” the battery with an automobile battery or its charging system. Doing so could result in injury or property damage from such causes as a battery explosion, or acid or electrical burns.

! WARNING

TO AVOID PERSONAL INJURY OR PROPERTY DAMAGE:

- Do not touch the positive (+) battery post and any surrounding metal with tools, jewelry, or other metal objects. Doing so could cause a short circuit that could result in electrical burns or an explosion of battery gases.
- Never bring a gasoline can near the positive (+) battery post. A short circuit caused by touching the gasoline can to the post could cause an explosion of the gasoline or of battery gases. Always fill the engine fuel tank from the front or side of the engine.

OUR RECOMMENDED METHOD:

Charge the battery at a rate of 1 to 2 amperes until all cells are gassing freely. The total charging time should not exceed 24 hours.

FIRST ALTERNATIVE: Charge the battery at a rate of 4 to 6 amperes until all cells are gassing freely. The total charging time should not exceed 8 hours.

SECOND ALTERNATIVE: Charge the battery at a rate of 6 to 12 amperes until all cells are gassing freely. The total charging time should not exceed 4 hours.

B. When the battery is fully charged, turn off the charging equipment and then disconnect the cables.

C. Check the electrolyte level in each cell. If necessary, add electrolyte until it just touches the lowest part of the filler wells.

D. Replace the six filler caps securely.

E. Use a baking soda and water solution to wash off any electrolyte which may have spilled on the battery.

STEP 2: Connect the wire harness receptacle

A. Plug the key switch assembly into the wire harness receptacle as shown in Photo 32. Press the parts firmly together to ensure a good connection.

B. Remove the pair of ignition keys from the key switch and put them in a secure place. Do not replace a key in the switch until you have read Sections 1, 2 and 3 in your PTO HORSE Model Owner/Operator Manual.

! WARNING

To prevent injury from accidental or unauthorized starting, always remove the key from the switch when leaving the tiller unattended or when the tiller is not in use.

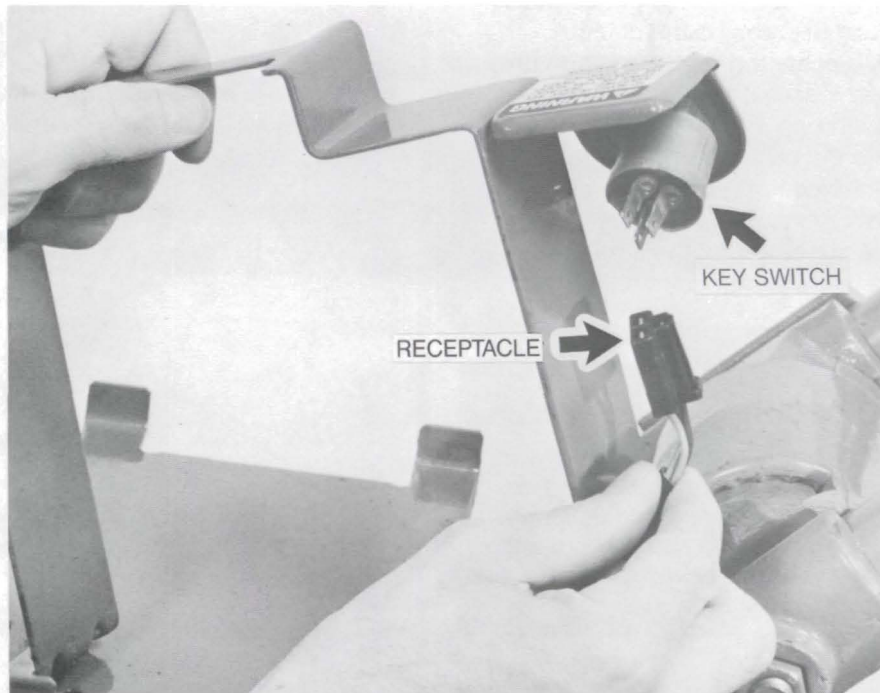

(Photo 32) Connect key switch to wire harness receptacle.

STEP 3: Installing the battery

A. Carefully place the battery on the battery mounting bracket with the battery posts facing to the rear of the tiller (Photo 33). Make certain that the positive (+) post is on the left side of the tiller as you face forward from the operator's position behind the handlebars.

CAUTION

Make certain that the battery is installed as described in Step A above. If it is installed incorrectly, damage could result to the battery or to other electrical system parts.

B. Place the battery hold-down bracket over the battery as shown in Photo 34.

C. Fasten the two sides of the clamp to the bracket using the two carriage bolts, lockwashers and hex nuts that you removed previously. Insert the bolts up through the bracket and clamp and add the lockwashers and nuts. Tighten the clamp enough to prevent the battery from moving, but do not bend the tabs on the clamp.

D. Locate the battery venting tube that is shown in Photo 3 on page 1. Insert one end of the tube down into the vent tube shield that is attached to the right side of the battery mounting bracket. Fasten the upper end of the tube to the vent fitting on the battery (Photo 35).

WARNING

Make certain that the battery vent tube is not crimped, pinched, or folded anywhere along its length. Improper venting could cause the battery to explode, resulting in severe personal injury.

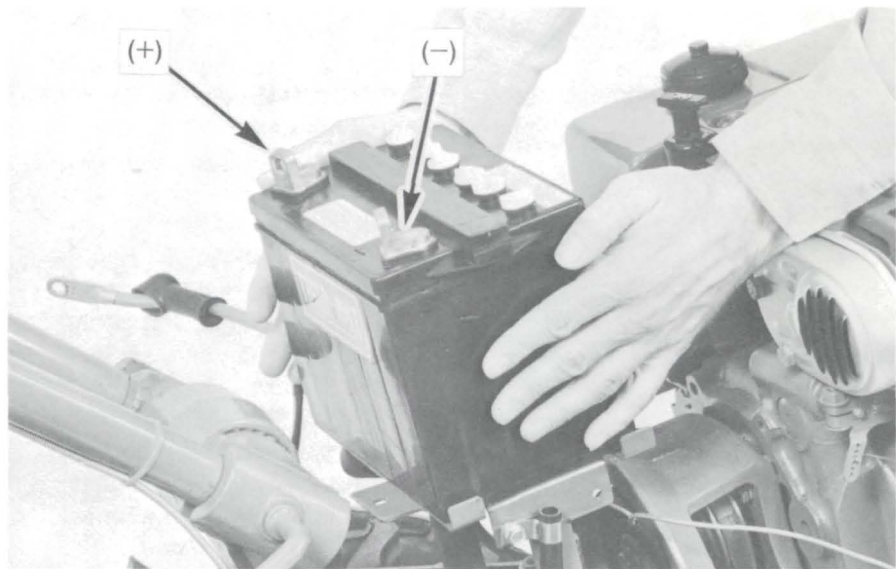

(Photo 33) Battery posts face to rear of tiller.

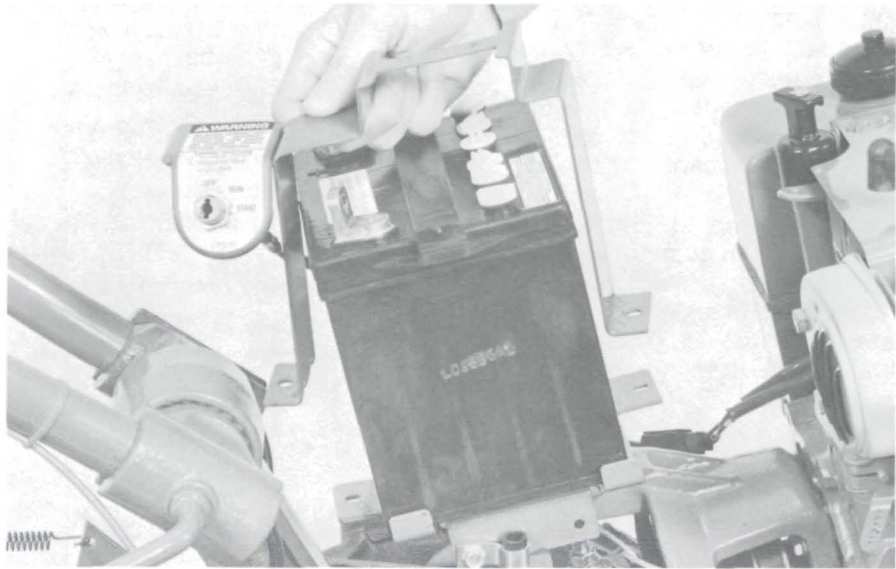

(Photo 34) Install hold-down clamp.

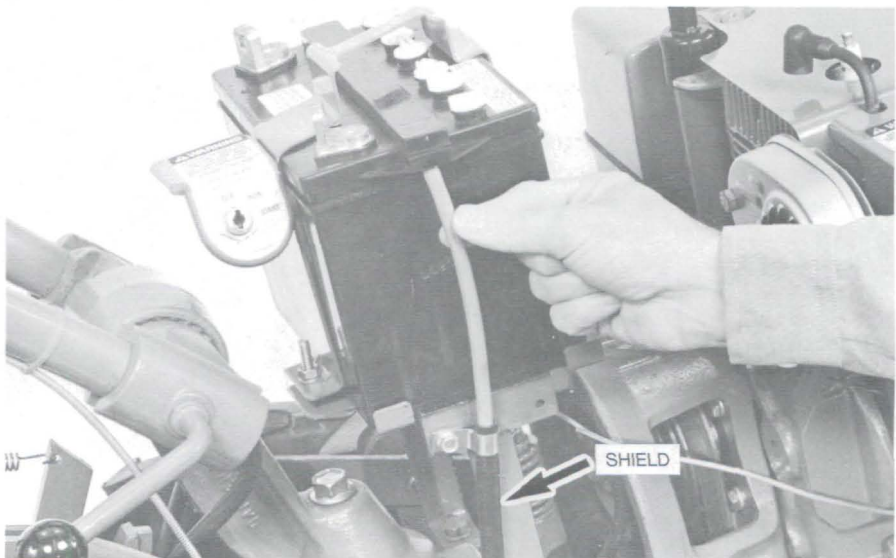

(Photo 35) Install vent tube.

STEP 4: Installing the battery cables

A. Locate the two (2) 3/4" bolts and 5/16" hex nuts that are shown in Photo 3 on page 1.

B. Connect the loose end of the positive (+) battery cable (the thick, red cable that is already attached to the solenoid) to the positive (+) post on the battery. Place the cable terminal on the side of the post that faces the battery caps and add the bolt and nut (head of bolt should face toward handlebars). Tighten the bolt and nut with two 1/2" wrenches (Photo 36).

C. Slide the rubber boot on the cable up and over the battery post, making sure that the boot covers the post completely.

D. Locate the negative (-) battery cable and the insulated rubber boot that are shown in Photo 3 on page 1. Slide the rubber boot

onto the cable.

E. Place one end of the cable on the side of the negative (-) post that faces the battery caps and add the bolt and nut (head of bolt should face toward handlebars). Bend the loose end of the cable away from any metal parts on the tiller and tighten the bolt and nut with your wrenches. See Photo 37.

F. Slide the rubber boot on the cable up and over the battery post, making sure that the boot covers the post completely.

G. Using a 3/8" wrench, remove the grounding screw from the vent tube shield clamp located on the right side of the battery bracket (Photo 38). To ensure a good ground when the cable is attached in the next step, scrape away any

paint from the hole in the bracket.

H. Place the cable terminal behind the clamp and securely replace the grounding screw (Photo 39).

I. Check that the lower end of the vent tube shield is located in front of the wheel shaft (axle).

J. Your electric start tiller is now fully assembled.

WARNING

To avoid personal injury or damage to equipment, do not attempt to operate the tiller or its engine until you have read and thoroughly understand all of the Safety, Controls and Operating Instructions in the separate PTO HORSE Model Owner/Operator Manual.

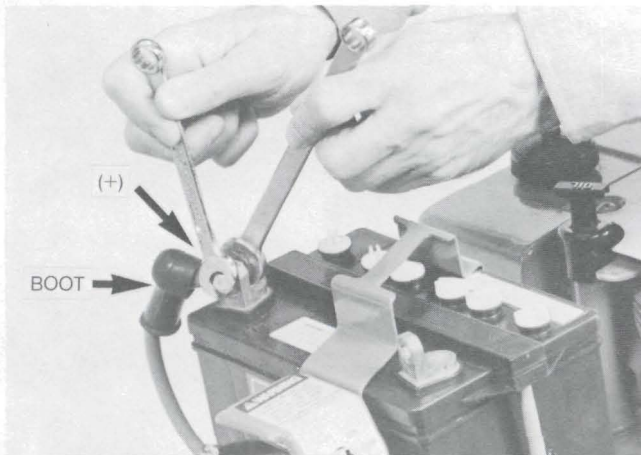

(Photo 36) Connect positive (+) cable to positive (+) battery post. Then cover post with rubber boot.

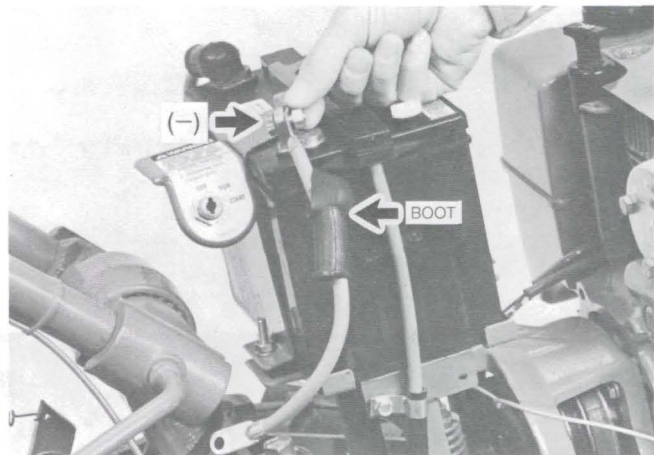

(Photo 37) Connect negative (-) cable to negative (-) battery post. Then cover post with rubber boot.

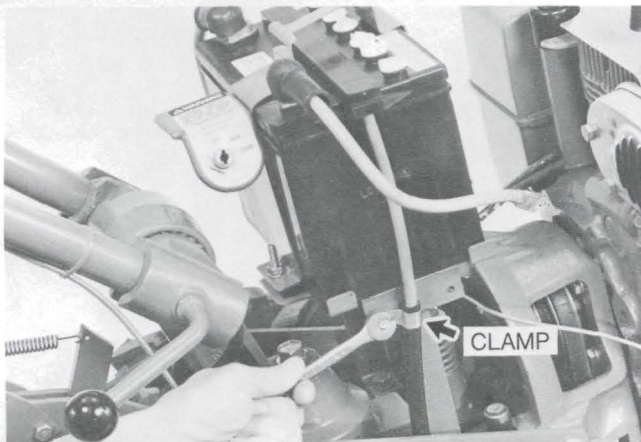

(Photo 38) Remove grounding screw and clamp.

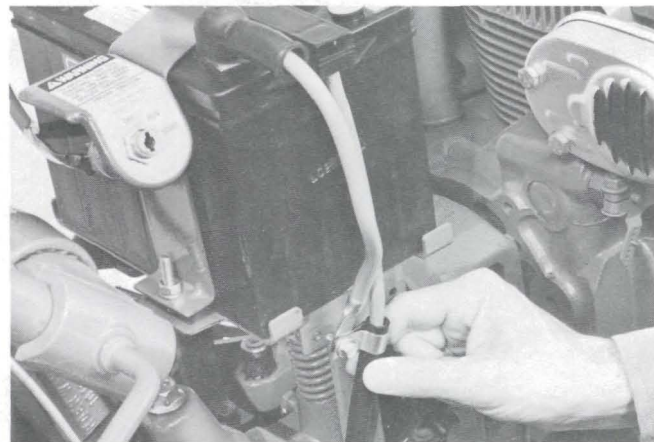

(Photo 39) Attach negative (-) cable and clamp.

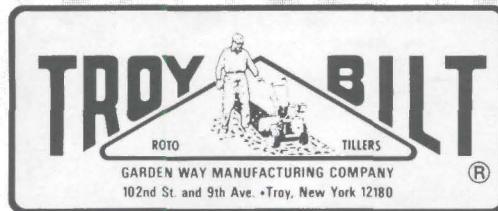

GARDEN WAY MANUFACTURING COMPANY

102nd Street and 9th Avenue, Troy, New York 12180

Phone TOLL-FREE: 1-800-833-6990

From Alaska Call Collect: (518) 235-6010

GARDEN WAY CANADA, INC.

514 Carlingview Drive, Rexdale, Ontario M9W 5R3

Phone Collect: (416) 674-1502

BrentChalmers.com