

\$450

OWNER'S MANUAL

TROY-BILT® ROTO TILLER-POWER COMPOSTER

PONY® MODEL



BrentChalmers.com

A word about Safety...

The Pony Model Troy-Bilt Tiller has been designed with many safety features to protect individuals from harm. However, it is necessary for the operator to closely follow operating instructions and safety practices at all times. Failure to do so could result in personal injury or property damage! Please be sensible about how you use your tiller.

BASIC SAFETY RULES—There are *some* basic safety precautions you should keep in mind at all times (be sure to read *all* the safety precautions in Section 3):

1. Keep hands and feet away from revolving tines, belts, pulleys, wheels, or shafts.
2. Don't wear loose clothing that could get caught in moving parts of the tiller or its engine.
3. Do not put tines in soil if Wheel Drive Lever is in FREE WHEEL.
4. Remember: You can **ALWAYS STOP TILLER MOTION** by moving the Forward/Reverse Lever into NEUTRAL.
5. **Don't let children use the tiller.**
6. Don't make tiller repairs or adjustments with the engine running.
7. Don't try to till on a hill which is too steep for safety.
8. To prevent accidental starting, tuck the spark plug wire boot between two cooling fins on top of the engine. See Photo 4-8 in Section 4.
9. Do not run the engine in an enclosed area.
10. Do not fill the gasoline tank while the engine is running or hot. It can cause a fire or explosion.

REMEMBER ...

PRACTICE SAFETY AT ALL TIMES!

WARNING TO ALL CALIFORNIA TILLER OPERATORS

Under California Law, you are not permitted to operate an internal combustion engine using hydrocarbon fuels on any forest-covered, brush covered, or grass covered land, or land covered with grain, hay or other flammable agricultural crop, without an engine spark arrestor in continuous effective working order. The engine that runs your tiller, like most garden or lawn equipment, is an internal combustion engine that burns gasoline (a hydrocarbon fuel); therefore it must be equipped with a spark arrestor muffler in proper working order. The spark arrestor must be attached to the engine exhaust system in such a manner that flames or heat from the system will not ignite flammable material. Failure of the operator to comply with this regulation is a misdemeanor under California law.

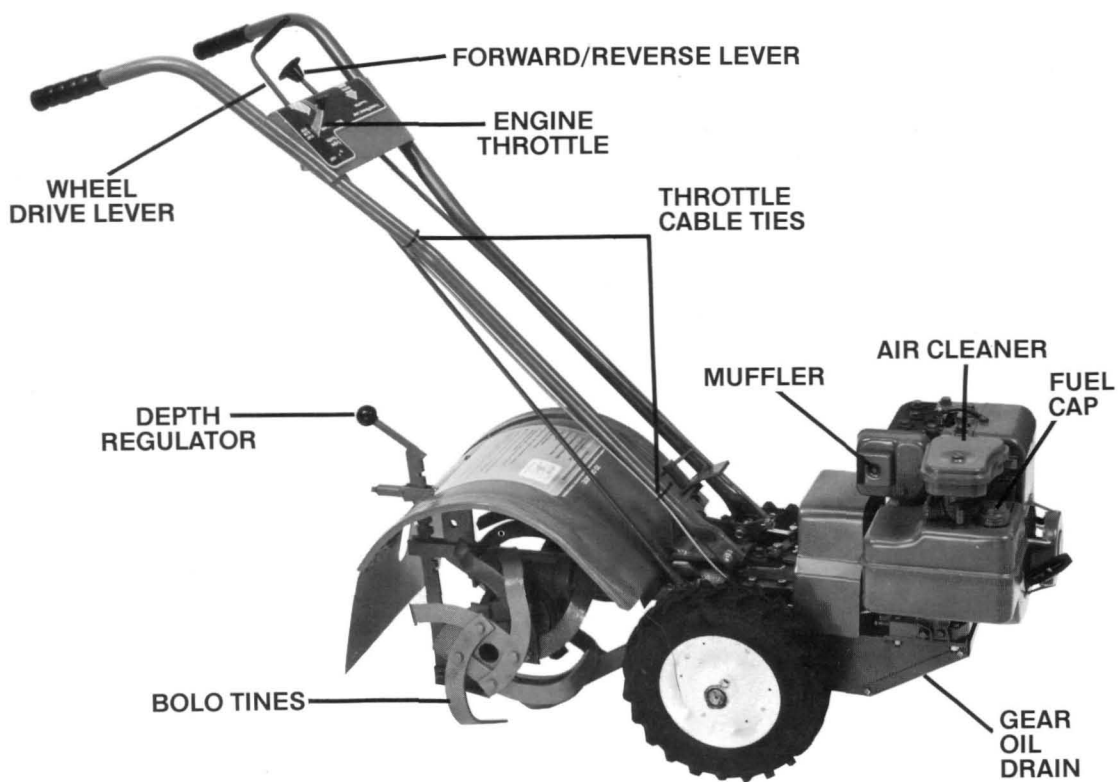

THE PONY MODEL TROY-BILT ROTO TILLER-POWER COMPOSTER

INTRODUCTION

Your Pony Model Troy-Bilt Roto Tiller-Power Composter is a basically simple machine to operate and to handle, but there are certain things which you should know before operating your tiller, and certain precautions which you should follow. For these reasons, please read carefully and understand the pages about Easy Assembly, Tiller Controls, Safety, Engine Controls, and Operation of the Tiller in this manual before attempting to operate the tiller.

Your Pony Tiller was designed with the engine up front, with the wheels in the middle at the balance point, and with the tines in the rear. This combination (perfected in the Horse Model Troy-Bilt) has proven itself through the years to give the best possible tilling results. It makes it possible to easily chop up, shred and bury all sorts of vegetation and other organic matter and return it directly into your garden to replenish the soil with nourishment either following the harvest of crops, or in building soil by tilling under lush green manure crops that were grown for that purpose.

By cover cropping and tilling those crops in and later adding crop residues and all sorts of organic materials such as leaves, mulch, waste vegetation and composted materials,



you can enrich your soil and enjoy harvests of far more delicious and wholesome vegetables than you ever expected. This transformation in your garden can happen in a few short years or less, depending upon how well you continually "feed your garden." That's right. You feed your garden and it will keep you well fed for years.



Your tiller has a rugged gear-driven transmission which runs continuously in a bath of gear oil. Separate forward or reverse drive belts deliver maximum power to the transmission to drive the wheels and tines. The powered wheels of your tiller not only propel the machine but also hold back the tiller sufficiently so that the tines can dig completely and effectively.

Your tiller was designed and manufactured to provide you with a highly versatile gardening tool which should last a lifetime. You can ensure long-lasting and high performance from your tiller far beyond your expectations by always giving it good care in the manner described in this manual.

WHY WE CALL IT THE PONY MODEL TROY-BILT ROTO TILLER-POWER COMPOSTER

Throughout this owner's manual, we call this tiller the Pony Model Troy-Bilt, in order to distinguish this model from the bigger and stronger Horse Model, and from other models that have been available in the past or might be produced in the future.

Our history dates back to the old Rototiller Corporation days in the 1930's, the company that introduced rear-end rotary tillage to America in 1930 and built the first rear-tined tiller in America in 1932. The first rear-end tillers the company built in Troy were manufactured in 1937 in the same building where we built the first Horse Model Troy-Bilt in 1961. We're still building our current four-speed Horse models and your Pony at the same location.



This is the factory in Troy, N.Y., where we've been making rear-end tillers for 40 years.

BrentChalmers.com

IF YOU HAVE TILLER SERVICE QUESTIONS — we are as close as your telephone with our 24-HOUR SERVICE HOTLINE.

Here's what to do:

1. Look at the Index at the back of this manual to find the listing which covers the subject you need. Then, turn to the pages listed to see if the solution to your problem is given either there or on other pages in that general category. Possibly your search will lead you to another section of this manual that will provide you with a solution.
2. Next, if you haven't found your answer, write to our Service Department (Garden Way Manufacturing Company, 102nd Street and 9th Avenue, Troy, NY 12180, U.S.A.
3. Or, if you can't find your answer in the book, and it's urgent, call us here at the factory on our 24-HOUR SERVICE HOTLINE: Area Code 518, 235-6010, Troy, New York.

OUR TELEPHONE SERVICE HOTLINE is in operation 24 hours a day, 365 days a year. It is attended personally from 8:00 AM to 4:30 PM (Eastern Time), Monday through Friday. For other hours of the day, and for weekends and holidays, an automatic answering machine will record your message. One of us will take care of your questions the following work day.

The whole idea behind the TROY-BILT® SERVICE "HOTLINE" is to get parts, attachments and service advice out to you just as quickly as possible; also, to answer any questions you may have about tilling or gardening, by phone or by letter, depending upon what is needed.

IF YOU NEED ENGINE SERVICE — If engine service or repair is needed, contact an authorized Briggs & Stratton Service Center. To serve you promptly and efficiently, the Service Center will need the model, type and code number on your engine (see first paragraph in Section 4 of this Owner's Manual). If you have trouble obtaining service or parts locally, please write to us or call here at the factory.

Your nearest service center is listed in the telephone "Yellow Pages" under "Engines, Gasoline" or "Gasoline Engines." It is one of more than 25,000 authorized dealers available to serve you.

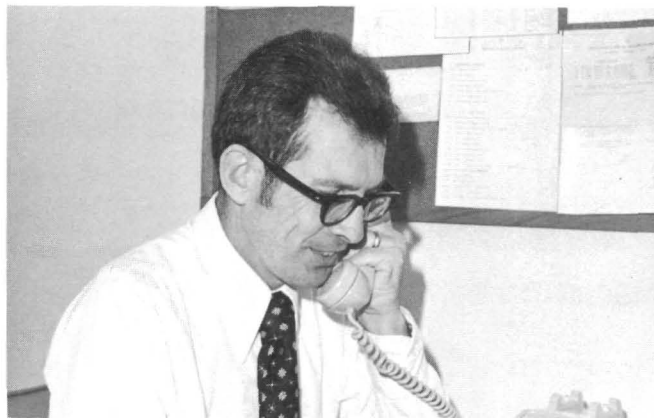

Our Service Department is as close as your phone!



Naturally each Troy-Bilt part is always in stock, ready to go at a moment's notice. Call anytime of the day or night or write for immediate, speedy shipment.



We keep you up-to-date at least once a year on service hints, latest developments at the factory and gardening advice, plus a helpful exchange of news and tips from other Troy-Bilt owners everywhere.

TABLE OF CONTENTS

	Page
SECTION 1	
Easy Assembly	5
SECTION 2	
Tiller Controls	18
SECTION 3	
Safety	23, 24
SECTION 4	
Engine Controls and Operation	25
SECTION 5	
Operation of Tiller	28
SECTION 6	
Maintenance and Service of Tiller and Engine	43
Specifications and Description	61, 62
Index	62-64
Warranty	Inside Back Cover

WHERE TO FIND TILLER SERIAL NUMBER

SERIAL NUMBER — If you have a problem with your Pony Model Troy-Bilt Tiller or you need parts, we need to know your tiller serial number when you write or call. An arrow in the photo below points to the top of the transmission, where the number will be stamped in the metal.

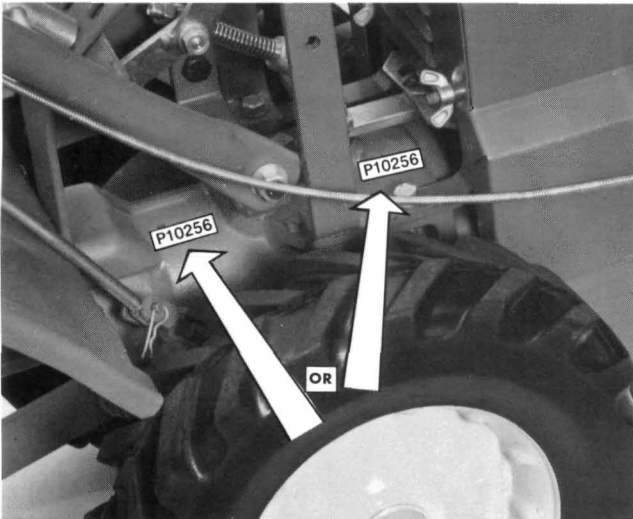

Pony Model Tiller Serial Number is:

P 92497

Write your tiller serial number here for handy reference.

The Date of Delivery: _____
(record date)

Engine model number is:

130 292 1139 01 82010806

Model No. Type Code

IF YOU NEED TO ORDER A PART FOR YOUR TILLER

If you need to order a tiller part, please use the Part Number given in the Parts Catalog (sent along with the owner's manual). When you have located the number for the part you want, please refer to the Parts Price List and use the accompanying Order Form. There, you will find detailed instructions on how to complete your parts order.

Also, please understand that we will ship your parts order to you C.O.D. if you have not sent us enough money to cover all costs. We pay C.O.D. fees, ordinary postage, or United Parcel Delivery costs. We do not pay the freight costs for extra heavy items such as engines or transmissions.

Some replacement parts that you receive may vary slightly in shape, color, or texture from the original part on your tiller. This is because certain parts are supplied to us by different vendors. Such variations, of course, do not change the operation and performance of the Pony Model Troy-Bilt.

Nothing is more important to all of us here at the Tiller Factory than making sure that every single Troy-Bilt® Owner is completely satisfied 100 percent of the time. You're always entitled to first rate service. Please know that we will do our best to see that you get it at all times.

Dean Leith, Jr.

Dean Leith, Jr., Sales Manager

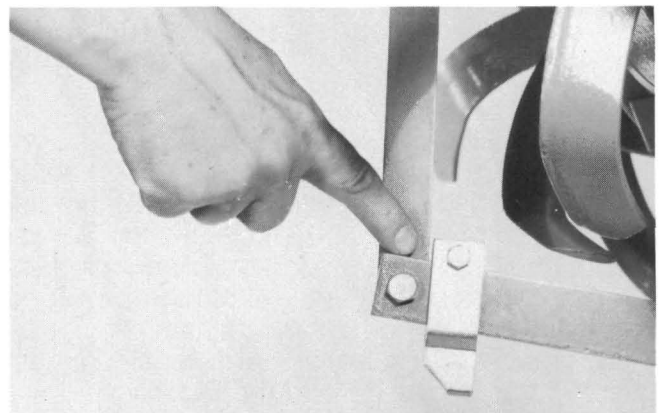

YOUR SOD POINT IS IMPORTANT

Your Pony's Sod Point is absolutely essential for proper and satisfying tilling performance of your PONY. The Sod Point attaches to the drag bar underneath your tiller (as you'll see on Page 12 of this manual). Attach it carefully according to the instructions. More details about using the Sod Point correctly will be found in Section 5, Tiller Operation.

BrentChalmers.com

SECTION 1 – EASY ASSEMBLY

1

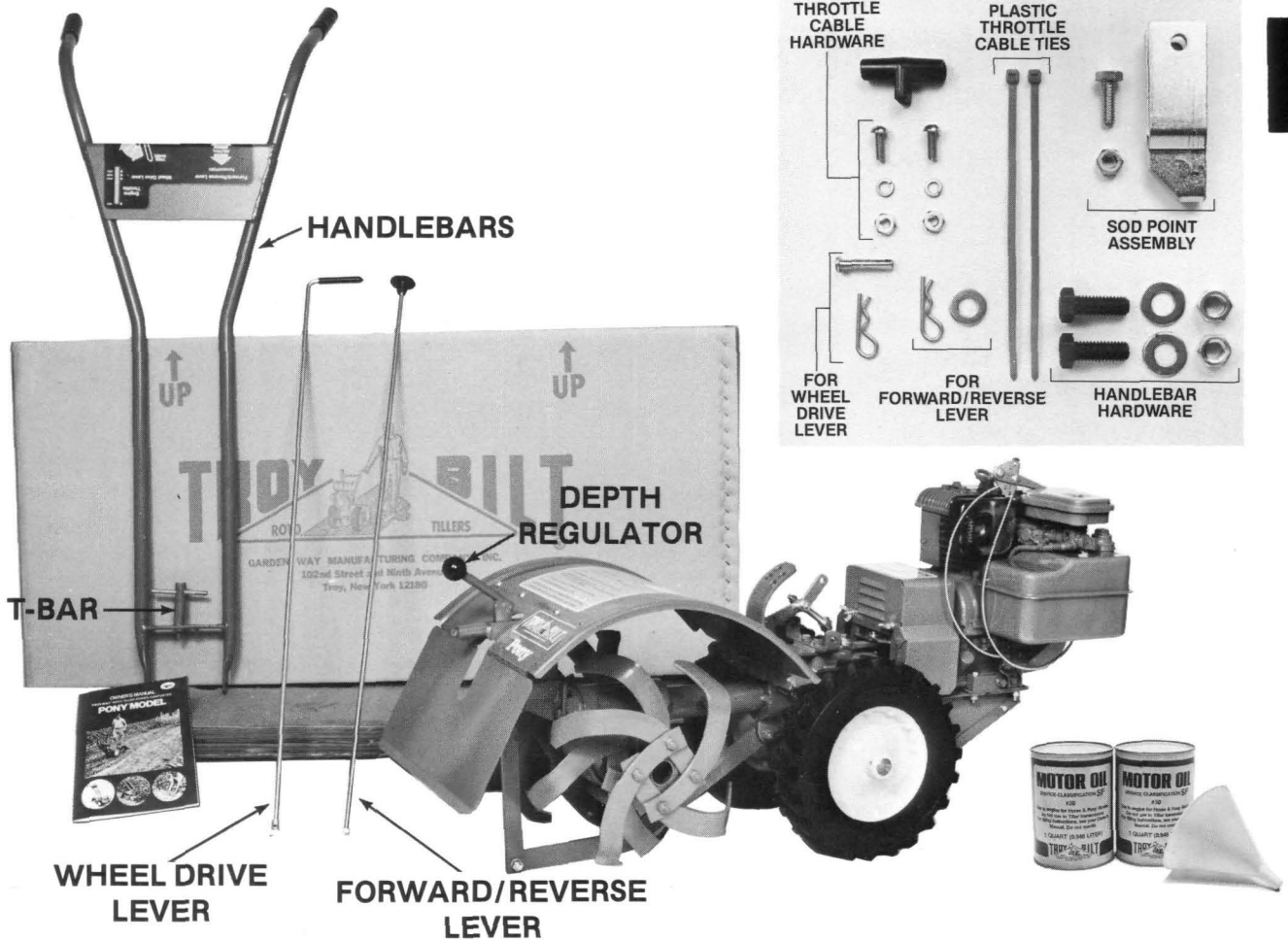

(Photo 1-1)

As you opened the shipping carton, you found your tiller assembled except for the following parts noted in Photo 1-1 above:

- The handlebars.
- The Forward/Reverse Lever — rod, with black knob at top.
- The Wheel Drive Lever—rod with a right-angle bend and a plastic grip at top.
- The Engine Throttle cable and control coiled around the engine at front. We adjust the throttle at the factory and ship it coiled this way to make sure that it is properly adjusted once it is attached to the handlebars.
- A plastic package containing the attachment hardware shown in the photo inset above.
- The proper motor oil for your engine (two cans are included: enough for first filling and one oil change) and a funnel.

We recommend that you use the **EASY ASSEMBLY** steps that follow on page 6.

FREIGHT DAMAGE OR MISSING PARTS

IF YOU NOTICE ANY DAMAGE either at the time of delivery, or later during assembly, here's what to do! Make sure that you put it in writing within 15 days that you intend to file a claim. Tell the driver, or phone the truck terminal that you intend to file a written claim. They will advise you how to proceed from there so you'll get complete satisfaction with any claim you may have. But, if you have any problem with this procedure, please let us know so we can lend a hand. The letter confirming your order also had additional information describing exactly what to do in case of damage.

IF YOU THINK SOMETHING IS MISSING—notify the freight company just the same as above. But, if you have any questions about anything that we can be helpful with, please call or write to us here at the factory.

STEP 1

CHECK TRANSMISSION GEAR OIL LEVEL

1

For your convenience we have installed gear oil in the transmission of your tiller right at the Factory (SAE 140 gear oil). But before you use your tiller, we urge you to double-check to see that the gear oil is right up to the proper level. Your Pony transmission holds approximately 3¼ pints (52-54 ounces). This is a very easy check to make — and an important one.

A. First be sure that the transmission is as level as possible — lower the depth adjustment bar as shown in Photo 1-2 so the tines will be 1"–2" off the ground in the "travel position".

B. Remove the oil level plug on the left side of the transmission as Photo 1-3 shows. The oil should start to flow out the oil level hole — indi-

cating that the correct amount of gear oil is in the transmission. If gear oil does flow out, the level is correct and your check is finished. Just replace the oil level plug and go on to STEP 2 about adding motor oil. If the transmission does need gear oil though, see statement "C" below on how to do this.

C. To add gear oil to the transmission, remove the plug for the oil fill hole on top of the transmission (see Photo 1-4) with a 7/16" wrench, and insert the funnel in the hole as shown in Photo 1-5. Add gear oil until it starts to flow out the oil level hole. Then replace the oil level plug and the oil fill plug. **NOTE:** add only SAE 140 gear oil (the grade that came inside your transmission) or SAE 90 gear oil. They're available at service stations, auto parts or farm equipment supply stores. Do not use multi-viscosity gear oil.

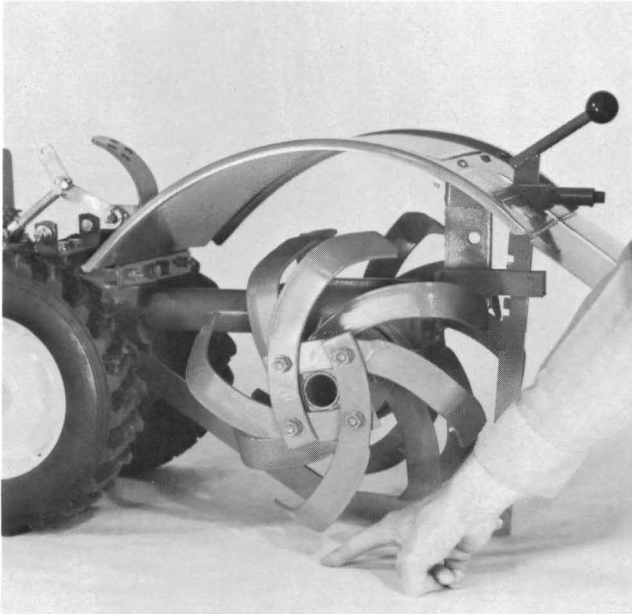

(Photo 1-2) Tines off floor, transmission level.

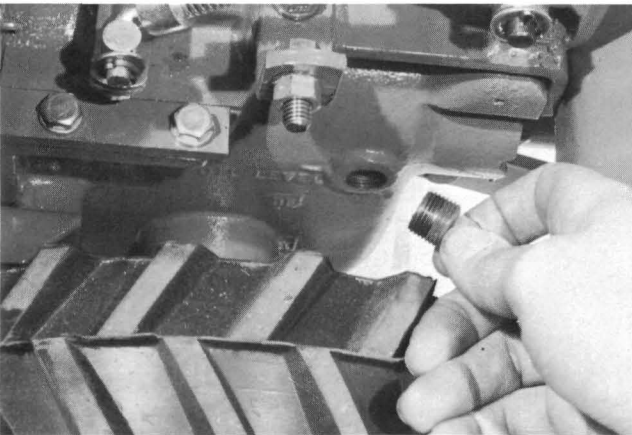

(Photo 1-3) Gear oil level plug. Transmission oil should flow out when the level is correct.

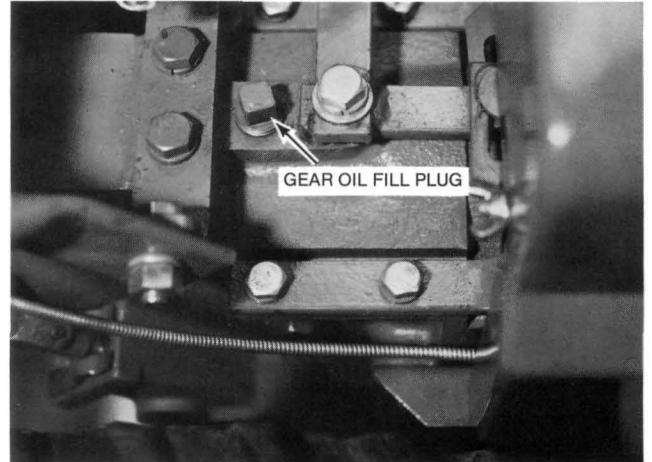

(Photo 1-4) Remove oil fill plug to add gear oil.



(Photo 1-5) Add gear oil if necessary.

STEP 2

FILLING THE ENGINE CRANKCASE WITH MOTOR OIL

— Make sure the tiller is located on a level spot and leave the tiller tines in travel position to keep the engine base level. Use 1¼ pints of motor oil we sent with your tiller. This will amount to a little over one-half of one of the cans. The second can of motor oil is for your first oil change, which you'll want to do after the first five hours of operation. As you can see on the can label, we supply #30 viscosity oil that is rated SF, the best rating for your engine's protection. With all future oil changes, be certain that the bottle or can of oil you use is marked with either an SF or SE rating (either rating may be used because both SF and SE grades are high quality oils).

NOTE: Read your Briggs & Stratton Engine owner's pamphlet thoroughly for complete instructions and warranty.

To Add Motor Oil —

A. Unscrew the OIL FILL cap on the left side of the engine as shown in Photo 1-6.

B. With engine base level, pour your quality SF classified #30 viscosity engine oil into the filler hole until the oil reaches the point of overflowing — see Photo 1-7. This is the point at which your oil level should always be maintained. Check it regularly.

C. Replace the filler cap securely.

CAUTION: Always maintain the engine oil level at the point of overflowing. This is extremely important. Some folks have just assumed it was O.K. because they were able to "see" the oil and have run their engines low on oil, causing expensive engine damage.

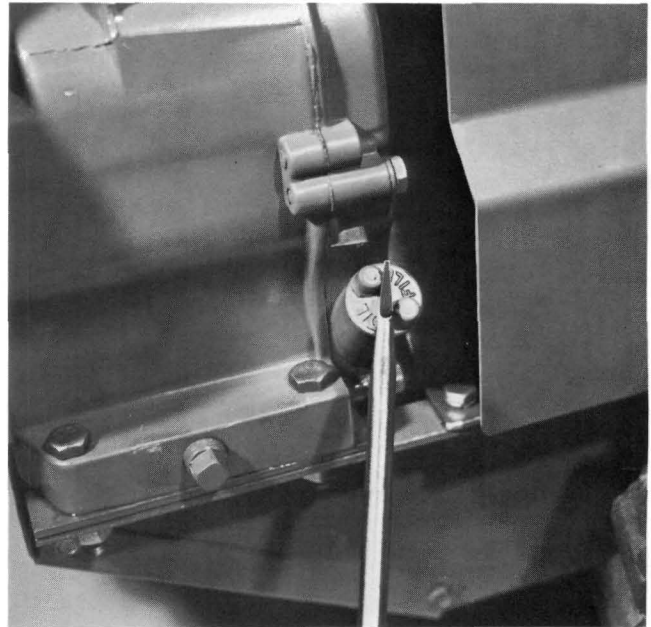

(Photo 1-6) *Unscrew engine oil fill cap.*



(Photo 1-7) *Use SF or SE classification motor oil.*

STEP 3

ATTACHING THE HANDLEBARS

The handlebars attach easily to the bracket on top of the transmission housing with 3/8" bolts, washers and locknuts — see Photo 1-8. Bolts, etc. are in hardware pkg., see Photo 1-1.

A. First remove the T-Bar clamp and the washer at the bottom of the handlebars. You can now align the two mounting holes at the very ends of the handlebar with the holes in the bracket. See Photo 1-9 and 1-10.

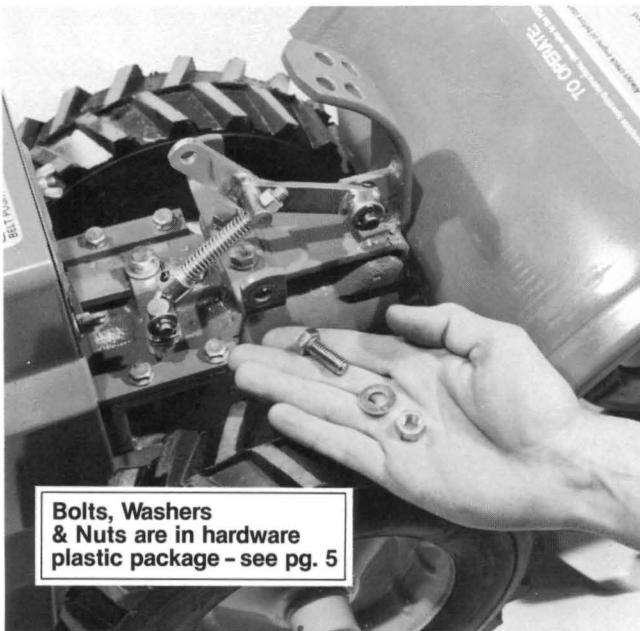

(Photo 1-8) Make sure the bolt head goes on the inside of handlebar mounting bracket.

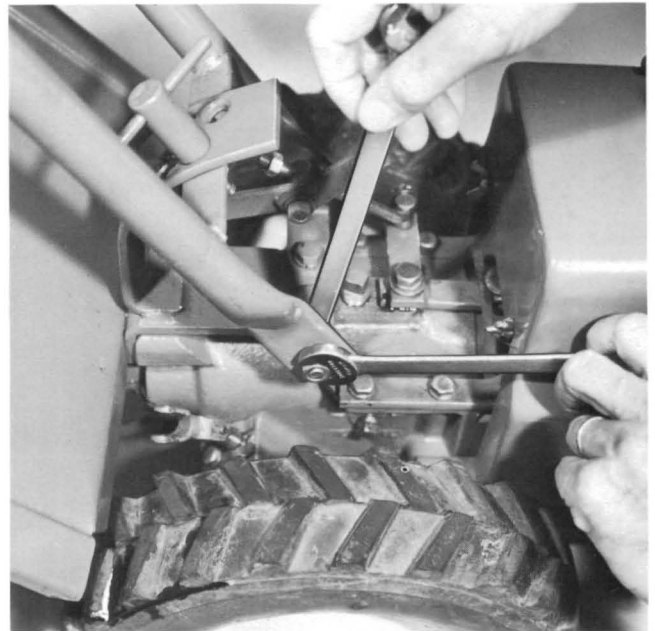

(Photo 1-10) Fasten handlebar with two wrenches.

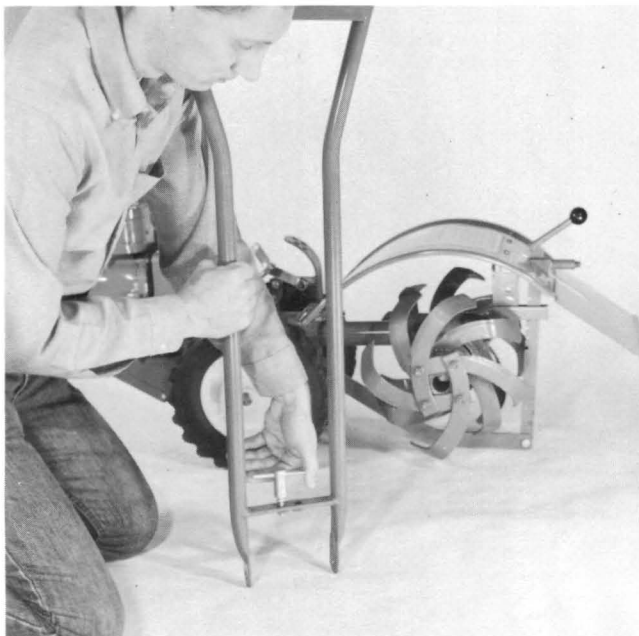

(Photo 1-9) Remove T-bar clamp.

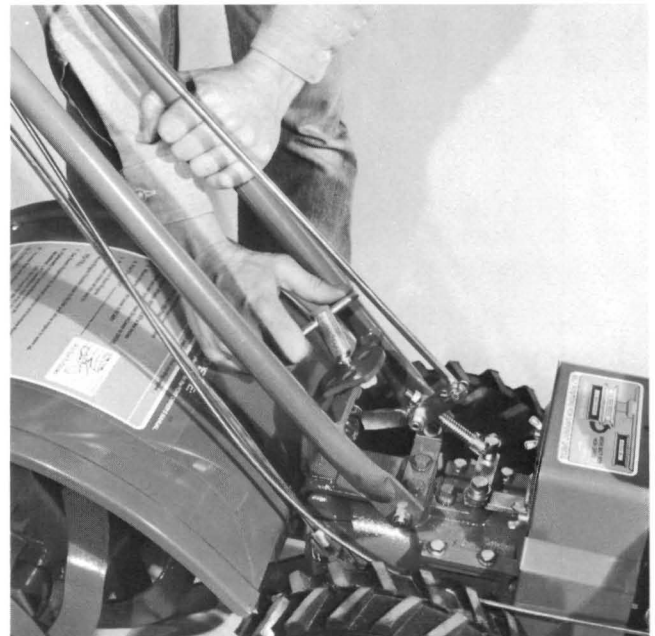

(Photo 1-11) Handlebar height is adjustable.

B. Insert the $\frac{3}{8}$ " bolts through the holes, add the washers and locknuts and tighten with two $\frac{1}{16}$ " wrenches. The bolt head goes on the inside and the locknut goes on the outside. See Photo 1-10.

C. There are four holes in the mounting bracket to adjust handlebar height. Select one of the top holes during assembly. Then, insert the T-bar through the selected crossbar hole (see Photo 1-11) and thread it into the hole. After the Wheel Drive Lever is installed you can use a lower hole to adjust height.

STEP 4

ATTACHING THROTTLE CABLE—The throttle cable and its control lever are wrapped around the fuel tank of the engine and are installed as follows. To mount the cable on the handlebar—

A. Unwind the cable from around the engine fuel tank (Photo 1-12).

B. Lay the throttle cable outside the belt cover and along the right handlebar, then up underneath to the handlebar panel. Remove the two engine throttle mounting screws, lockwashers and nuts from the plastic package.

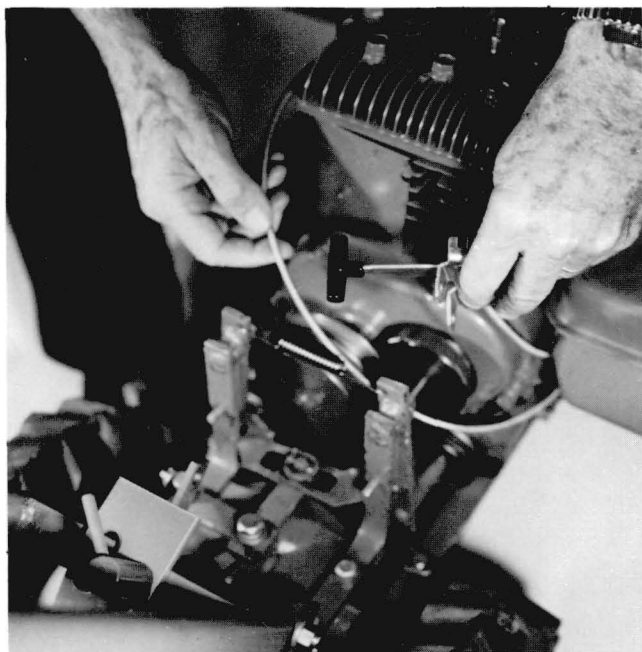

(Photo 1-12) *Carefully unwind throttle cable.*

C. Insert the lever up through the slot labeled ENGINE THROTTLE as shown in Photo 1-13. Line up the holes in the control and the panel. Take one of the screws and insert it through the “+” cuts on operator’s control panel decal. Place the lockwasher and nut on the screw and tighten a few turns—shown in Photo 1-13. Repeat the process with the second mounting screw, lockwasher and nut. Tighten both screws with a screwdriver.

D. Take the black, throttle control lever handle from the plastic shipping package, put it on the

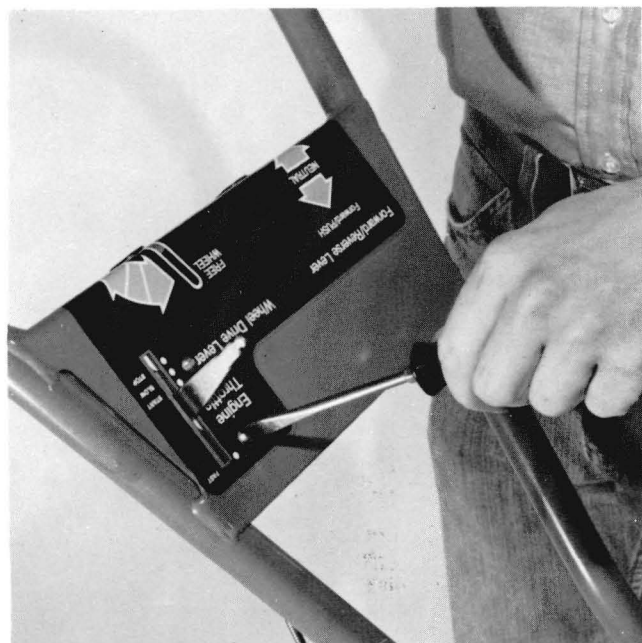

(Photo 1-13) *Insert screws through “+” marks and thread on lockwashers and nuts.*

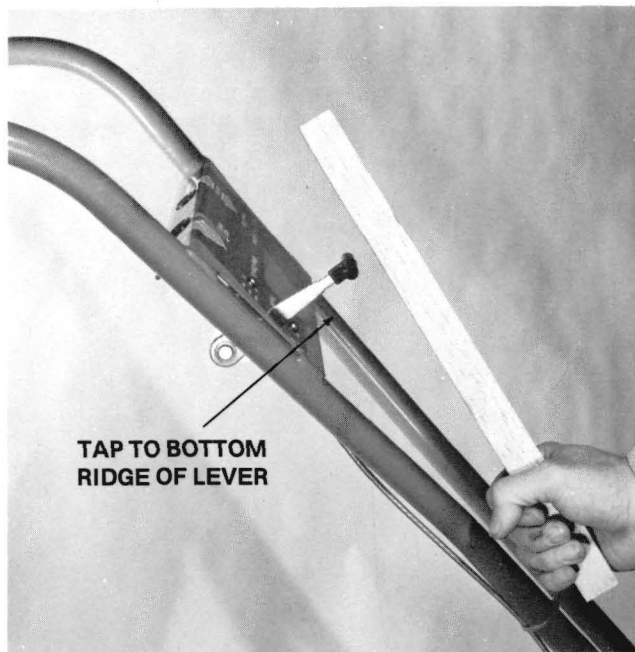

(Photo 1-14) *Tap handle down to bottom ledge on lever.*

lever, and tap it down to the bottom ridge of the lever as indicated in Photo 1-14.

E. Wrap one plastic tie around the cable and the bottom of the handlebar as shown in Photo 1-15. Put the serrated face of the plastic tie towards the inside of the loop. Wrap the second plastic tie around the cable and handlebar just above the point where the handlebar starts to bend outward. Pull the ties up very tight and snip off excess plastic tie. See Photo 1-16.

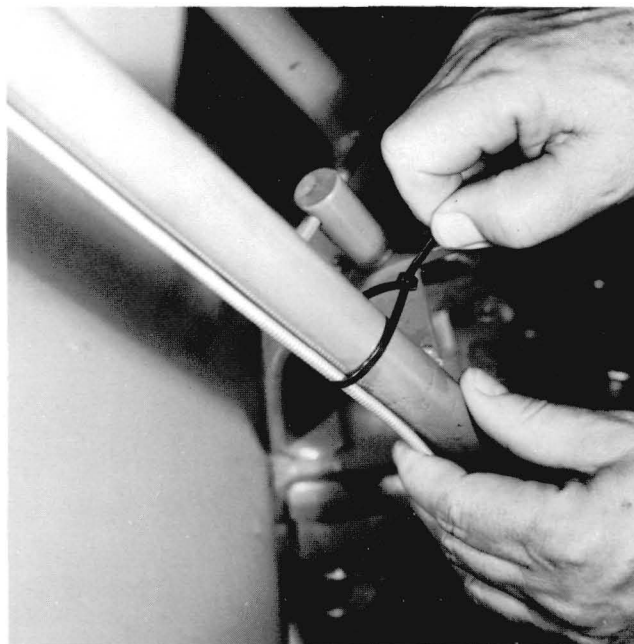

(Photo 1-15) *Pull plastic tie until tight.*

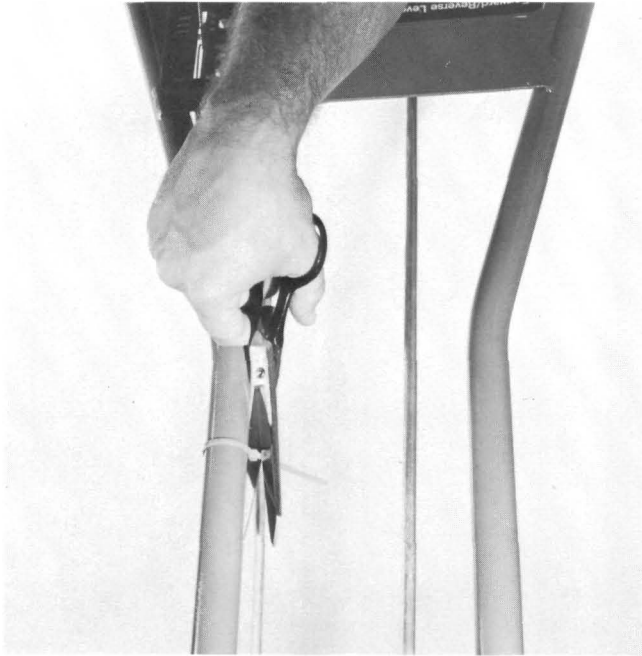

(Photo 1-16) *Snip excess off ties.*

A WORD ABOUT TILLER CONTROLS . . .

If you look at Photo 1-17 you will see the bottoms of the two main tiller controls, the Wheel Drive Lever on the left in the photo, and the Forward/Reverse Lever, on the right. Both of these levers have attachment hardware which you will find in the plastic shipping package. The hardware is shown in the inset to Photo 1-1, and Wheel Drive Lever and Forward/Reverse Lever are shown leaning against the carton.

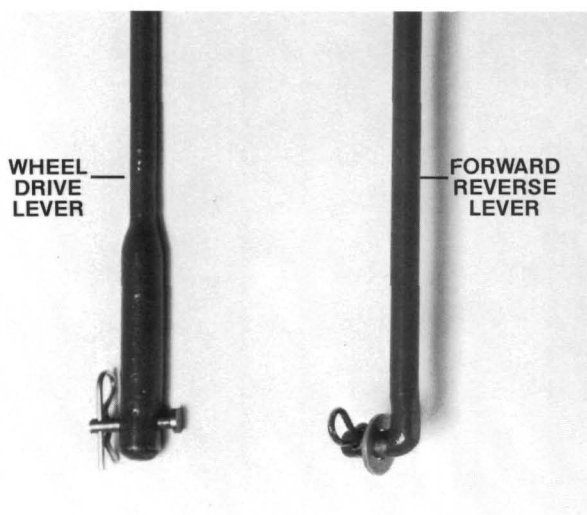

(Photo 1-17) **CONTROL LEVERS**—The photo shows the retaining pin and hitch pin for the Wheel Drive Lever on the left, and the washer and hitch pin for the Forward/Reverse Lever on the right.

STEP 5 □

ATTACHING THE FORWARD/REVERSE LEVER—This lever provides FORWARD or REVERSE motion of the wheels and tines. To attach lever:

A. Remove the hitch pin and washer from the plastic shipping package. Push the end of the lever down through the hole in the operator's control panel on the left side, as shown in Photo 1-18.

B. Insert the bent (bottom) end of the lever through the hole in the arm linked to the belt tightening assemblies (idler pulley assemblies). See Photo 1-19.

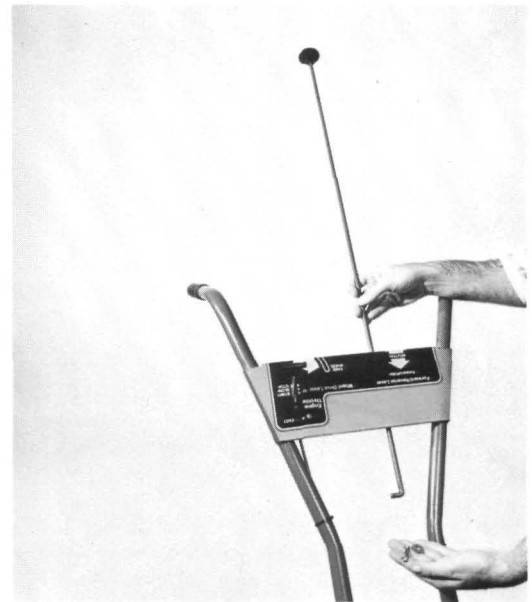

(Photo 1-18) *Installing Forward/Reverse Lever*

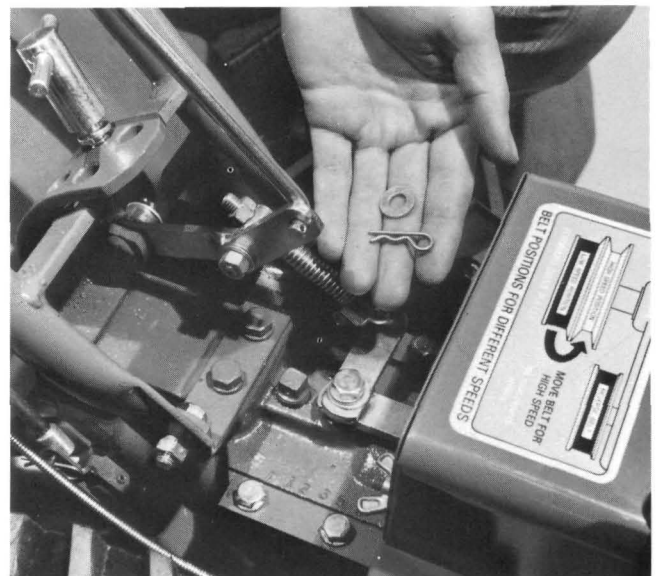

(Photo 1-19) *Lever goes through upright arm of linkage assembly.*

C. Slip the $\frac{5}{16}$ " washer over the end of the lever. Insert the hitch pin into the hole at the end of the lever to secure it in place—see Photo 1-20.



(Photo 1-20) Insert hitch pin.

STEP 6

ATTACHING THE WHEEL DRIVE LEVER — This lever, found at the right of the Forward/Reverse Lever on the control panel, moves the clutch into and out of Wheel DRIVE.—

To attach the Wheel Drive Lever:

A. Remove the retaining pin and the hitch pin from the plastic package. Then push the lever down through the hole in the operator's control panel labeled WHEEL DRIVE—see Photo 1-21.

B. Line up the hole at the bottom of the lever with the universal for the wheel clutch—at the right rear of the transmission housing—see Photo 1-22. Point the handle of the Wheel Drive Lever up toward FREE WHEEL as shown in Photo 1-23 and turn the universal as needed to line up the holes.

C. Insert the retaining pin through the Wheel Drive Lever and the universal and turn the lever back. Then, install the hitch pin as shown in Photo 1-24. Now you can readjust your handlebar height to a lower setting.

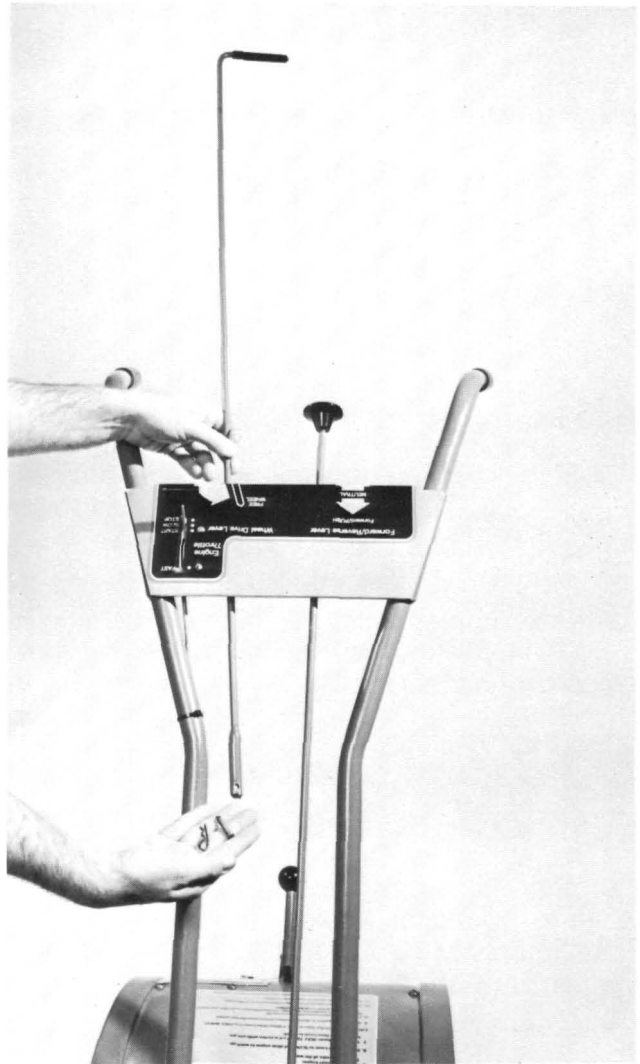

(Photo 1-21) Installing Wheel Drive Lever

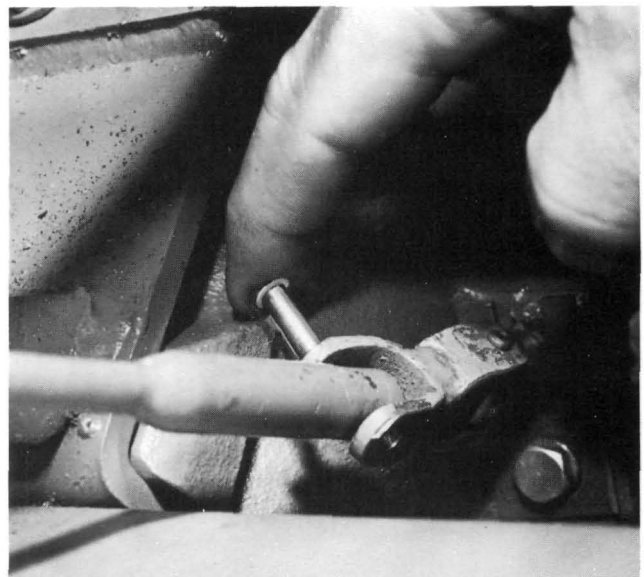

(Photo 1-22) Align holes in lever and universal.



(Photo 1-23) Point lever towards Free Wheel on control panel label.

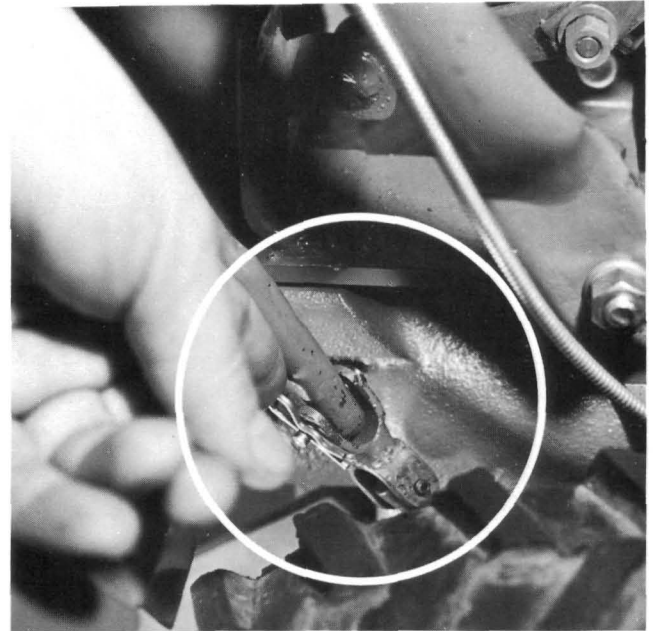

(Photo 1-24) Install hitch pin through lever and universal.

STEP 7 □

ATTACHING THE SOD POINT ASSEMBLY

— This assembly came in the plastic bag with the other small parts, inside the shipping container for your tiller. Make sure you use the Sod Point when you till. For further information see Section 5, page 28.

The Sod Point attaches easily to the drag bar under the tiller as shown in Photo 1-25. Remove the bolt and locknut and slip the Sod Point on the drag bar as shown in Photo 1-25. Insert the bolt and thread on the locknut. Tighten securely with $\frac{7}{16}$ -inch wrenches or adjustable wrenches.

The Sod Point is absolutely essential for proper Pony tilling, so please make sure you install it according to the instructions and keep it on your tiller.

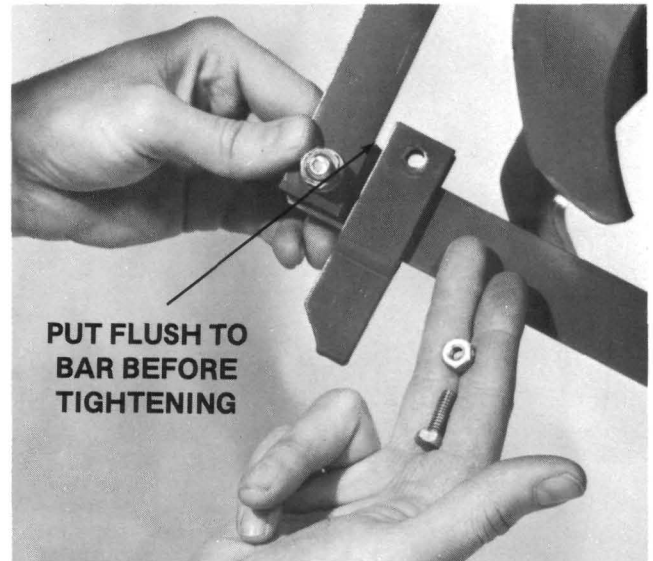

(Photo 1-25) Mount Sod Point snug against depth bar.

IF YOU HAVE A MANUAL START PONY, IT SHOULD BE FULLY ASSEMBLED NOW AND YOU CAN GO ON TO READ SECTION 2. IF YOU HAVE THE ELECTRIC START, CONTINUE WITH THESE FEW ADDITIONAL ASSEMBLY STEPS.

ASSEMBLING THE 5 HP BRIGGS & STRATTON ELECTRIC START PONY

Although all of the Briggs & Stratton engines on the Pony Tillers have Easy Spin Starting,[®] many people like the convenience of key starting, just like their cars. Just a turn of the key starts the engine, stops the engine, and when

the key is removed, the engine can't be started without taking a few additional steps. This means there is some security against children using the tiller without your supervision.

Of course, most of the electric start system is already assembled for you by us at the factory. The few remaining steps are easy and you'll be able to get your Pony working in the garden in short order. Important "How to Start and Stop" information is in Section 4 of the manual, and should you encounter any problems now or later, you can read "Troubleshooting" in Section 6.

CHECKING THE SPECIAL PARTS FOR THE ELECTRIC START

Most of the parts for your Electric Start Pony are already on your tiller, of course, but a few are packed in a box under the engine and in a special plastic envelope for electric hardware.

The parts you'll be using in assembly are shown in Photo 1-26 and are described below:

- A Troy-Bilt lead-acid battery, 12 volts, 12 amperes (in special box under the engine)
- A plastic vent tube for the battery (this is in the battery box)
- Battery cable. Connects battery negative post to bracket (ground). Includes rubber boot to cover post and cable end (see hardware pkg.).
- Long carriage bolts (8¼") and washers and nuts for battery clamp (see hardware pkg.).
- Short, metric size orig. equipment hex head/philips head bolts and nuts to secure cables to battery terminals (in battery box). Plus, extra cable-to-terminal bolts and nuts (U.S. size), if ever needed (in hardware package.).

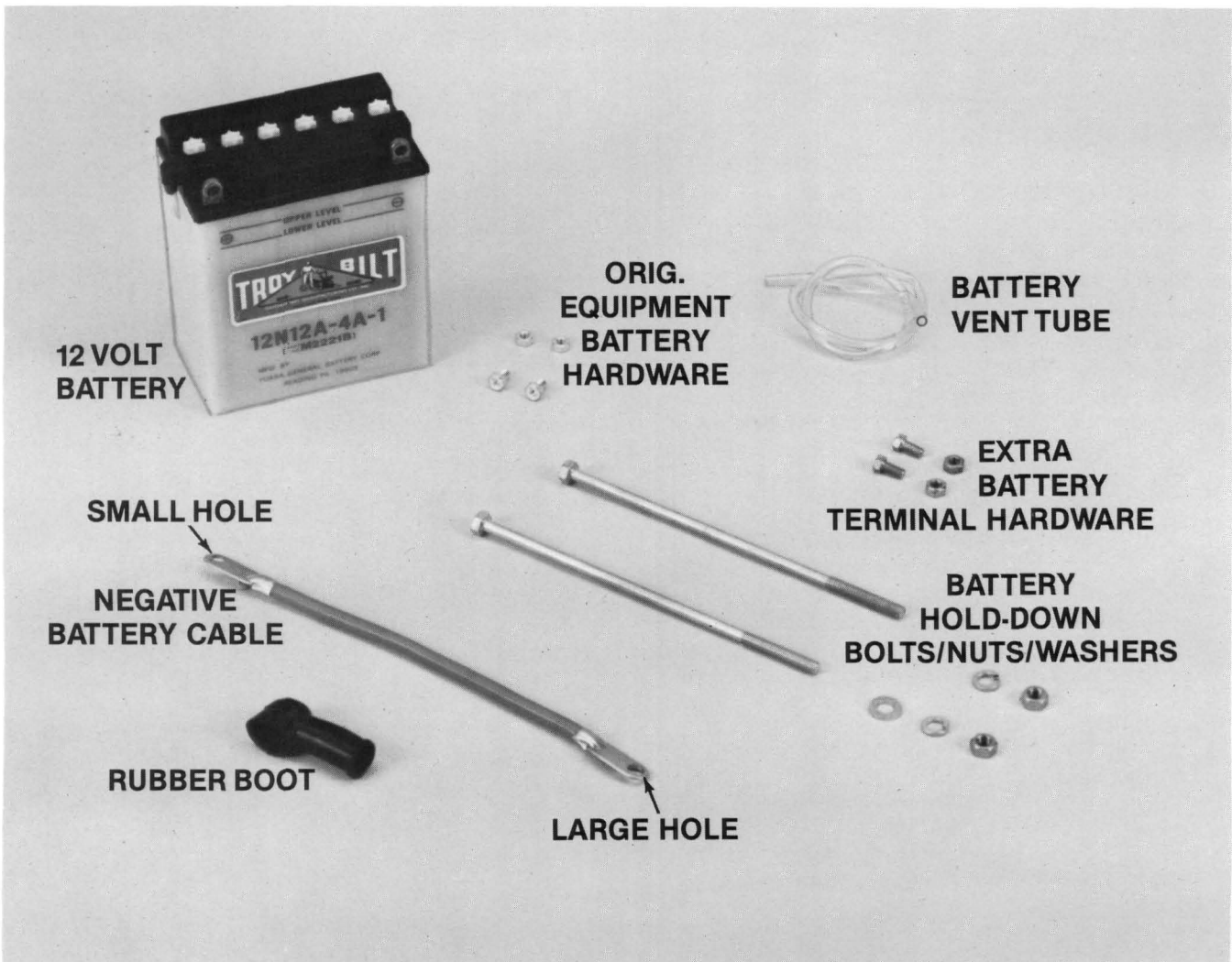

(Photo 1-26) All the electric start parts are already on your Pony except these few.

POISON/DANGER CAUSES SEVERE BURNS

Contains sulfuric acid. Avoid contact with skin, eyes or clothing. Antidote: EXTERNAL — Flush with water. INTERNAL — Drink large quantities water or milk. Follow with milk of magnesia, beaten egg or vegetable oil. Call physician immediately. EYES: Flush with water for 15 minutes and get prompt medical attention. BATTERIES PRODUCE EXPLOSIVE GASES. KEEP SPARKS, FLAMES, CIGARETTES AWAY. Always shield eyes when working near batteries. KEEP OUT OF REACH OF CHILDREN.

STEP 8

ACTIVATING THE BATTERY

The battery is activated by filling each of the six cells to the proper level with electrolyte (battery grade acid, which is sulfuric acid with a specific gravity of 1.265 for your battery).

THE EASY WAY TO ACTIVATE YOUR BATTERY — HAVE A SERVICE STATION DO IT

Most any service station can easily and quickly fill your TROY-BILT battery with the proper battery acid — and you won't have to purchase more battery acid than you actually need (note: battery acid is sometimes for sale only in large quantities).

The six cells of your PONY battery hold a total of 26-½ ounces of battery acid. And although your battery most probably won't require a "start-up" charge, the service station you select to do the work can put a 1 ampere trickle charge on the battery if necessary. If this is the case, be sure they charge the battery at Less than 1.8 Amperes — damage could result to the battery if a higher charge rate were to be used. See the CAUTION Statement below on this.

CAUTION: If the service station says your battery needs a charge, THEY MUST CHARGE AT LESS THAN 1.8 AMPERES. ANY CHARGE RATE OF MORE THAN 1.8 AMPERES WILL PERMANENTLY DAMAGE YOUR BATTERY. In general, a service station's recharging equipment is designed for much larger and more powerful automobile batteries, so be careful. If the service station can safely charge motorcycle batteries, they can safely charge your PONY'S battery. Remember — a trickle charge is all that's required.

IF YOU WANT TO ACTIVATE IT YOURSELF

A. You will be handling acid! Read acid warning. Keep a pail of water and box of baking soda around. They will help flush or partially neutralize acid spills. DO NOT ALLOW BAKING SODA IN OR AROUND OPEN BATTERY CELLS.

B. Purchase a quart of electrolyte, which is battery-grade sulfuric acid, with a specific

gravity of 1.265. If you must supply your own container, we suggest glass or acid resistant plastic — never metal. Also, you'll need a non-metal funnel with a small opening less than 3/8" across (don't use your oil funnel — oil will contaminate the battery).

C. Set your battery on a level surface, preferably a surface that won't be ruined by a little acid spillage, should any occur.

D. Remove all six battery caps with a screwdriver and fill each cell to the UPPER LEVEL MARKED ON THE BATTERY with battery acid. See Photo 1-27.

E. Let the battery sit 30 minutes. Go back and check the level of battery acid, filling each cell back up to the UPPER LEVEL IF NECESSARY, with the acid. Do *not* top off with water in this initial filling.

F. Wipe off any acid spillage and replace the caps, using a screwdriver to snug them down (don't tighten too much).

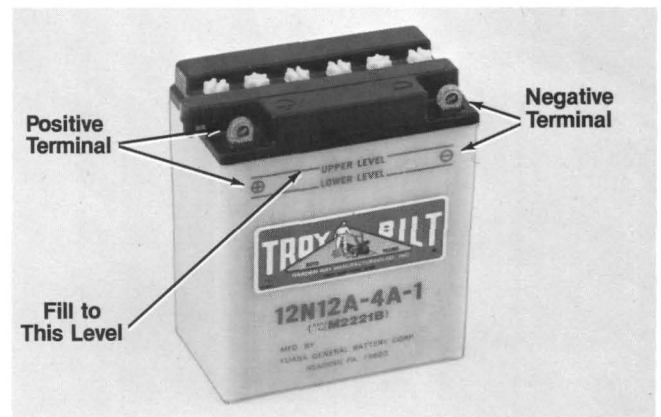

(Photo 1-27) Fill with battery acid to upper level shown here, wait 30 minutes, then top off again to that level.

STEP 9

INSTALLING AND WIRING THE BATTERY AND ELECTRIC START SYSTEM.

Installing the battery and wiring is comparatively easy and quick to do. Before proceeding though, you should read these instructions carefully and in full in order to get a good understanding of what you'll be doing as you complete each step. Especially note the very helpful SKETCH 1-28. It shows at a glance just how the wiring system is designed.

BrentChalmers.com

A. Using both hands, position the battery on the battery bracket with the post facing toward the rear of the tiller. Make sure that the positive (+) post is on the left hand side of the tiller as you face forward from the handlebars. The proper position for the battery and the side on which the positive post should be are shown in Photo 1-29. As an aside, it's always a good idea to wear rubber gloves when you're handling a charged battery (you can't be too careful when it comes to battery acid).



(Photo 1-29) Use two hands and position battery this way, positive (+) side to left rear of tiller.

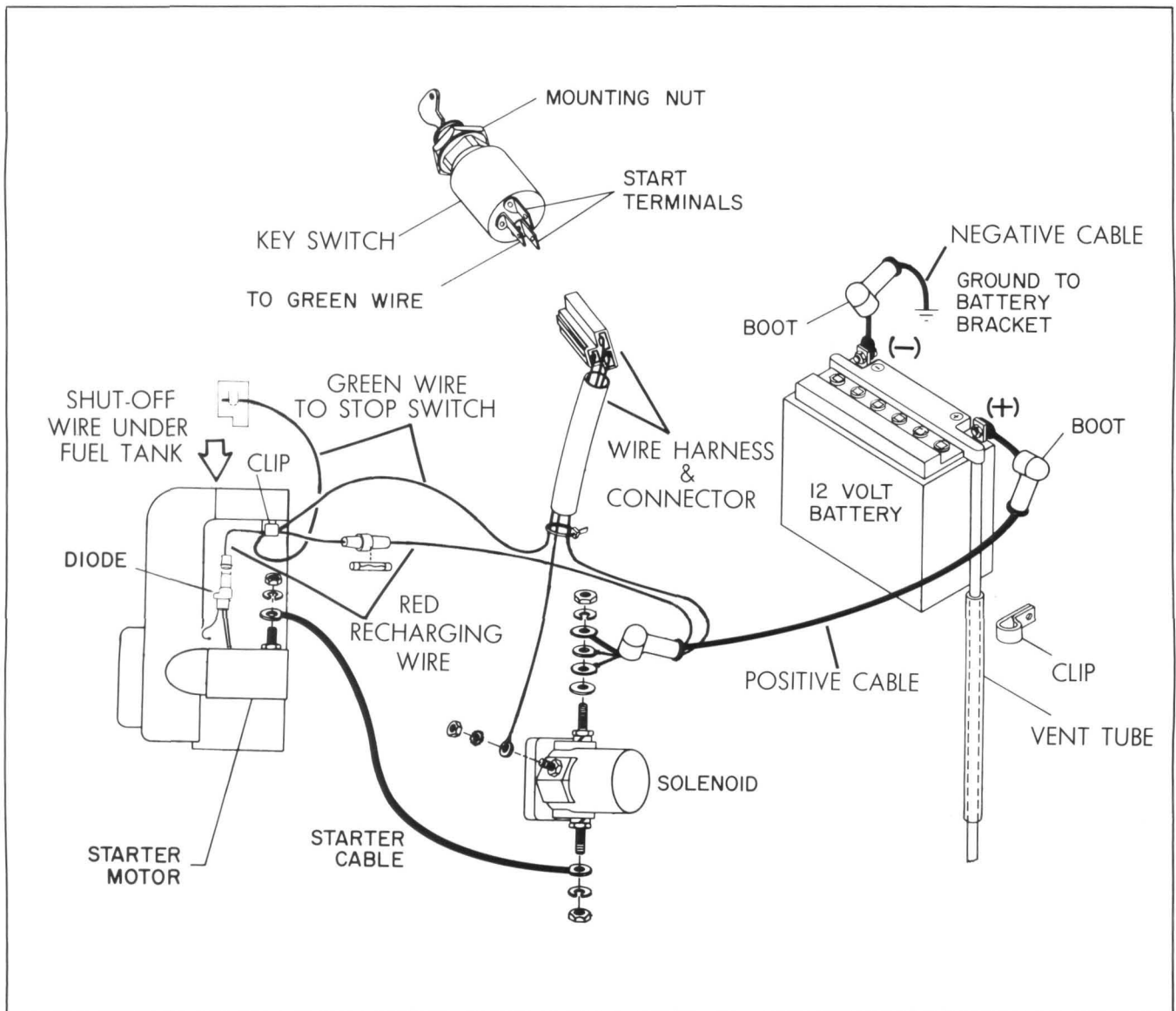

(Sketch 1-28) This is a simplified, but very helpful, view of how your Pony Electric System is wired.

1

B. Loosely bolt on the battery hold down clamp (it has the key switch attached to it). To do this, first be sure to center the clamp along the front edge of the battery and put the 8 1/4" long carriage bolts through the holes in the clamp and the bracket.

On the left clamp bolt, thread on the plain

washer, then the lockwasher, and then the nut — but only finger tight. On the right clamp, thread on the lockwasher, and then the nut — again finger tight, because you'll be removing the nut and the lockwasher later on in order to attach the negative battery cable). Refer to Sketch 1-30 below for a very helpful visual.

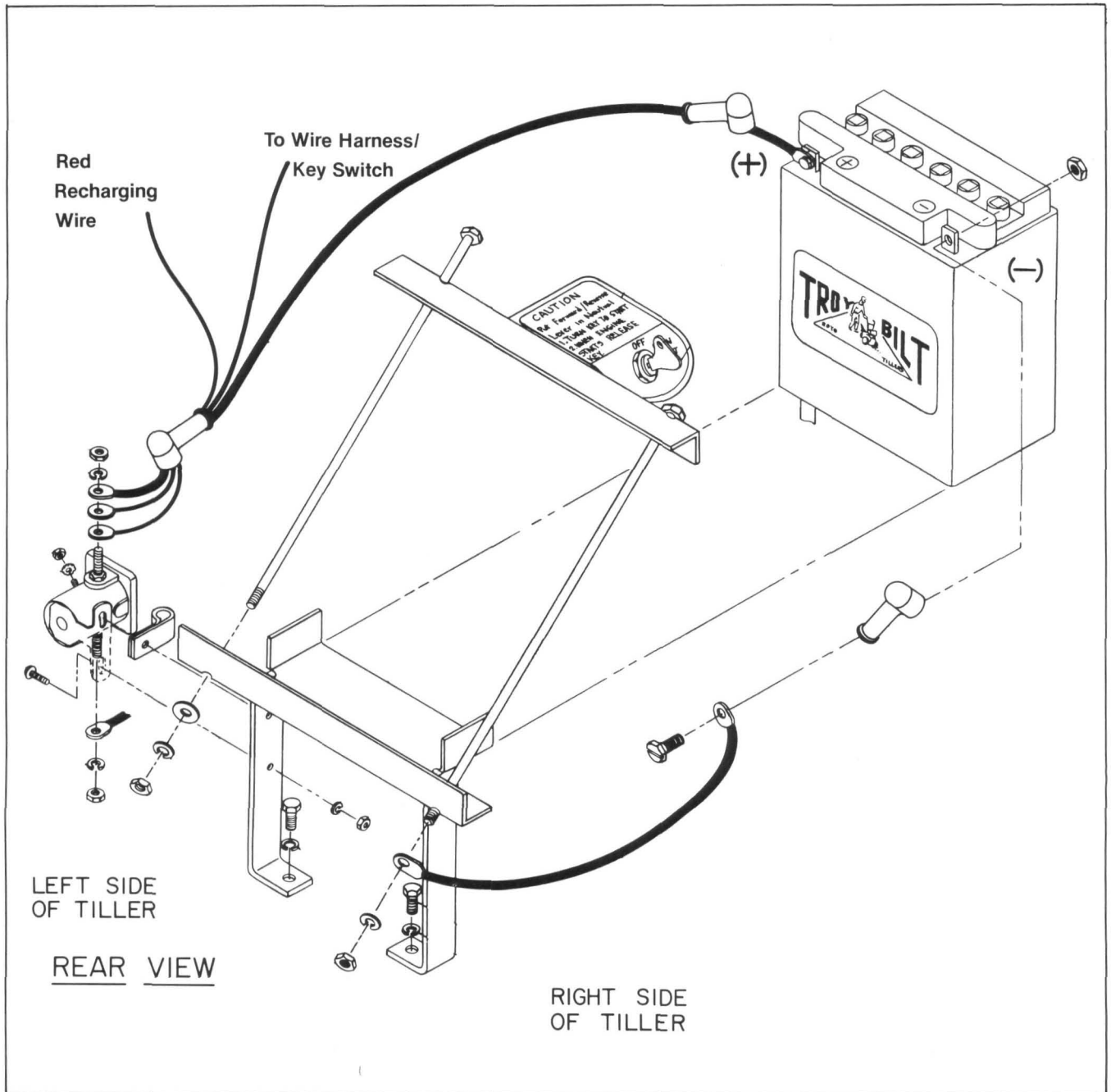

(Sketch 1-30) Here is how the battery bracket, clamp, and solenoid hardware locations relate to each other as viewed from the right rear side of the tiller. Be sure to attach the Negative Cable LAST, connecting it first at the battery terminal, then at the grounding point at the bottom of the 8 1/4" long carriage bolt.

C. Connect the **POSITIVE CABLE** to the **POSITIVE BATTERY POST (+)**. The positive cable is the one already connected to the starter solenoid (the small can-like part with three studs on it). Take one of the two bolts that came in the battery box and put it through the small offset hole in the cable terminal and through the positive post. Be sure **the small offset hole in the terminal faces down**, or the holes won't align. Then, thread on the nut and tighten with a philips head screwdriver and adjustable wrench, as shown in Photo 1-31. Slide the rubber boot over terminals.

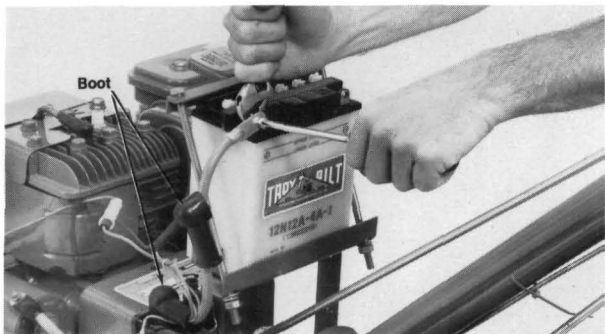

(Photo 1-31) Put bolt through cable terminal and hole in battery post. Thread on nut, use philips head screwdriver and adjustable wrench to tighten. Secure, but don't overtighten.

D. Remove battery cable and rubber boot from hardware package. The cable terminal with the small offset hole goes on at the negative battery post (again, offset hole face down). Pass the cable up through the boot and connect cable end to **NEG BATTERY POST**, using the last nut and bolt in the battery box. Slide boot over post.

E. The other end of the negative cable is used to ground the electrical system. Remove lockwasher and nut from the bottom of the right clamp bolt, slip the cable terminal over the bolt end, then replace the lockwasher and the nut (Photo 1-32).



(Photo 1-32) Remove nut and lockwasher, put cable terminal on bolt, replace the hardware.

F. Now, tighten the two clamp bolts a little at a time on both sides for even pressure. The clamp should be snug, but if you tighten too much, you could damage the battery.

The way to check proper tightness is to check the lockwashers. Just turn the nut hard enough so the lockwasher flattens out and no more.

G. Take the clear plastic vent tube and insert it down the black tube mounted along the left side of the transmission. Now take the upper end of the vent tube and put it on the vent fitting on the left side of the battery as shown in Photo 1-33. Make sure the vent tube is not crimped or folded anywhere along its length. If proper venting is not permitted, an explosion can result.



(Photo 1-33) Vent tube first goes down through rigid tube, then up onto vent fitting. For safety, make sure it's not kinked.

IMPORTANT! GET TO KNOW YOUR TILLER

This is a good time to take stock of what you have accomplished so far in putting your tiller together and getting it ready to run. What you should do now before going on is:

1. Study the photographs in Section 2 locating the controls and compare the photos with the actual controls on your tiller.
2. Work the tiller controls *without the engine running* until you understand what each does.
3. Read the Safety Precautions in Section 3.
4. Familiarize yourself with all of the engine controls. (Section 4 of this manual and the Briggs and Stratton Engine owner's pamphlet.)

SECTION 2 – TILLER CONTROLS

2



(Photo 2-1)

There are three tiller controls (and the engine throttle lever) which affect tiller operation. Shown in Photo 2-1, they are: the Wheel Drive Lever, Forward/Reverse Lever, and the Depth Regulator.

Before taking your tiller into the garden for the first time, try out each control without running the engine. See what they do, and how they work. Each control is discussed in more detail below—also see Photo 2-2.

WHEEL DRIVE LEVER — This lever (see Photo 2-2) has two operating positions: Drive and Free Wheel. In the Drive position it moves the clutch to engage the wheel drive gear, providing engine power to the wheels. In the Free Wheel position, the wheel gear is not engaged and you can freely move the tiller about without running the engine.

CAUTION: Before starting the engine, always make sure that this lever is in the Drive position. This is a safety precaution to make sure someone doesn't accidentally have the tines in the soil, the Forward/Reverse Lever in "Forward", the Wheel Drive Lever in Free Wheel, and then start the engine. If you did this, the tines would rapidly propel the tiller forward because the Wheel Drive Lever was in "Free Wheel" and the wheels would not hold the tiller back. Don't put REVOLVING TINES in soil when Wheel Drive Lever is in FREE WHEEL.

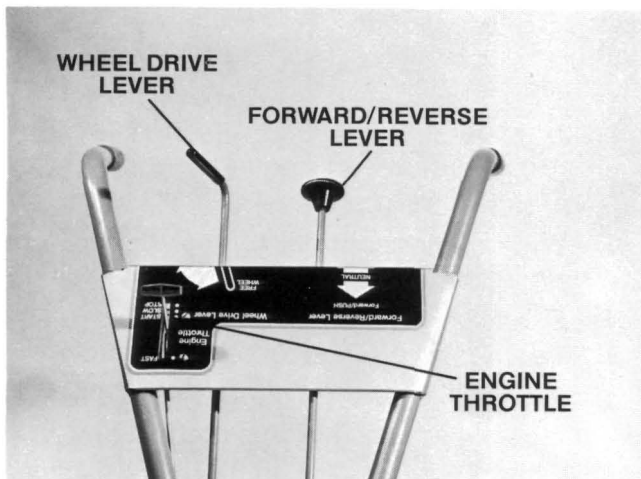

(Photo 2-2) Control levers.

When you turn the Wheel Drive Lever to the Drive position, you have to roll the tiller a few inches (either direction) to turn the clutch sufficiently to allow a lug to lock in a slot in the wheel gear.

Please be careful putting the lever in DRIVE. Don't force it! When you have the lever near the 4 or 5 o'clock position—shown on the operator control panel—and the wheels will no longer turn, you have the lever engaged. By putting gentle pressure on the lever and trying to roll the tiller a few inches you can recheck to make sure your tiller is fully engaged in DRIVE.



(Photo 2-3) Wheel Drive Lever in DRIVE.

TO OPERATE WHEEL DRIVE LEVER:

1. Roll the tiller a few inches while you (gently) turn the Wheel Drive Lever to DRIVE—see Photo 2-3.
2. To return to FREE WHEEL, simply turn the lever back toward the 12 o'clock position—see Photo 2-4.

2

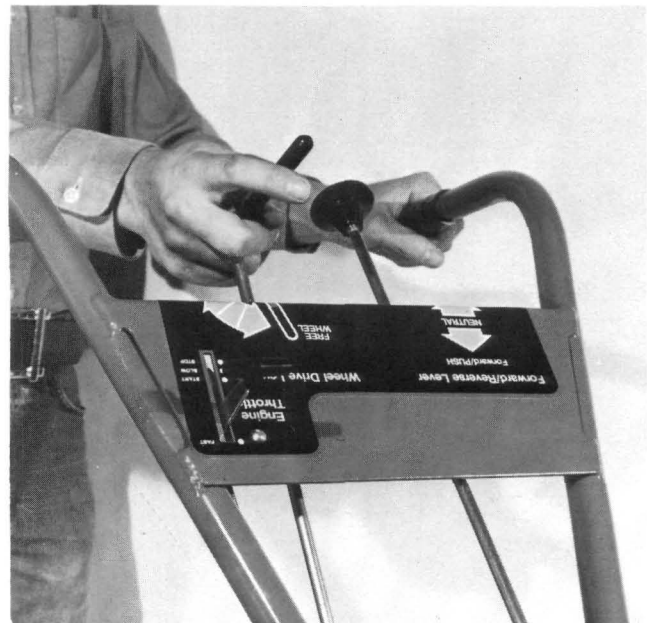

(Photo 2-4) Wheel Drive Lever in FREE WHEEL.

FORWARD/REVERSE LEVER — This lever provides Forward and Reverse motion for the tiller—see Photos 2-1 and 2-2. Each drive belt has an idler pulley arrangement that tightens or relaxes belt tension on the pulleys.

When you place the lever in either Forward or Reverse (while engine is running), the tines will revolve.

ATTENTION PLEASE...
The Forward/Reverse Lever is the most effective control to stop all tiller motion (except engine motion) when you do wish to do so in a hurry—or for just general pauses in tilling.

Always have the Forward/Reverse Lever in Neutral when starting.

When the lever is pushed all the way in for Forward, it will stay in Forward unless you pull it out to release it.

If you Pull the lever OUT and raise the tines off the ground by raising the handlebars, the tiller will move in Reverse as long as you

hold the lever OUT. When you release the Lever (from Reverse), the lever will automatically return to Neutral. This is a safety feature for your protection.

Another point about Reverse is that you should not till in reverse—for safety reasons. Reverse operation can be very helpful in tight places where you have to turn around.

Reverse has only one speed (which is rather slow, for safety).

Your Pony Model Tiller has two forward speeds — Low and High. To change speeds you must move the belt position on the pulleys — described on Page 37 of Section 5. Of course, the engine throttle control also governs both wheel and tine speeds by controlling how fast the belt driven pulleys turn.

Loosen the wing nuts and remove the belt cover. Then, look at the FORWARD drive pulley in Photo 2-5. The pulley groove closest to the operator position is low speed.

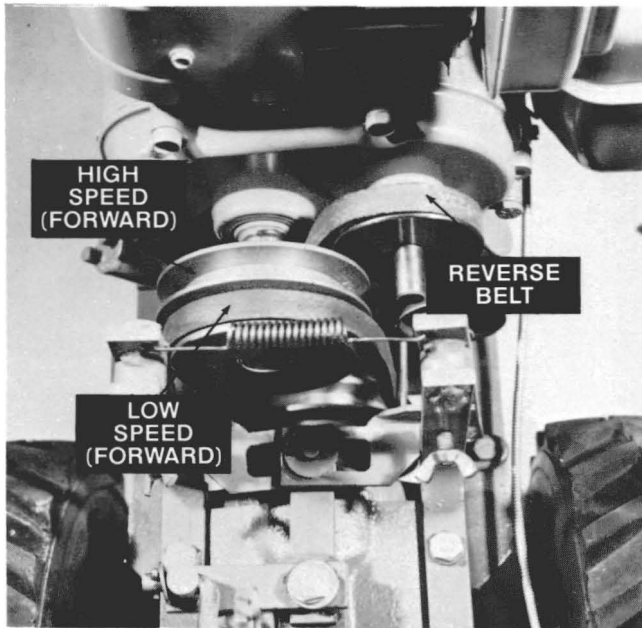

(Photo 2-5) Forward and Reverse pulleys

To OPERATE FORWARD/REVERSE LEVER:

CAUTION: Remember to put the Wheel Drive Lever in DRIVE before operating the Forward/Reverse Lever.

1. PUSH the lever in for FORWARD motion of the tiller—see Photo 2-6.

To return to NEUTRAL, simply PULL the lever OUT and let go.

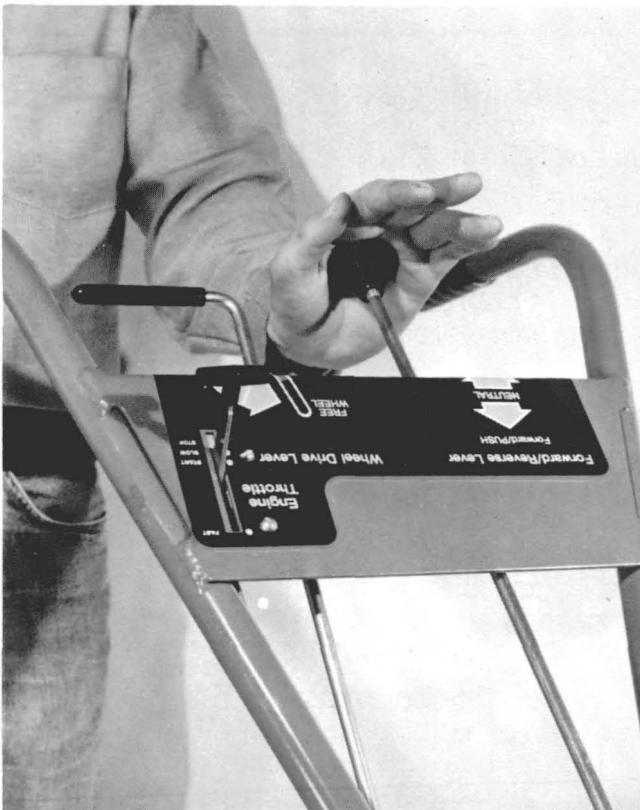

(Photo 2-6) To go Forward, push in.

2. For REVERSE motion of the tiller, raise the handlebars to get the tines off ground, and PULL—see Photos 2-7 and 2-8.

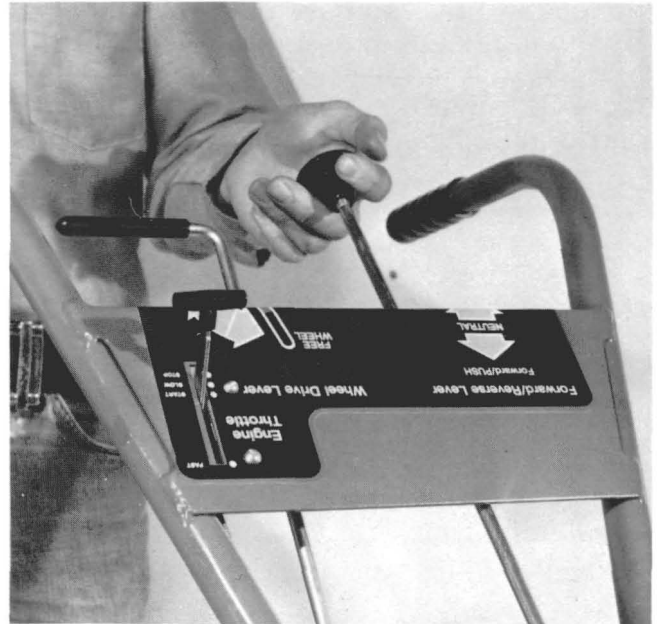

(Photo 2-7) Lift handlebars and PULL lever for Reverse.



(Photo 2-8) Use Reverse in tight places.

3. While in REVERSE, to return to Neutral, simply let go of the lever as shown in Photo 2-9.



(Photo 2-9) Release lever to stop Reverse.

DEPTH REGULATOR — The lever at the rear of the hood is the Depth Regulator. When you pull back on this lever, notches in the adjustment bar clear a pin and allow it to be moved up or down into any position—see

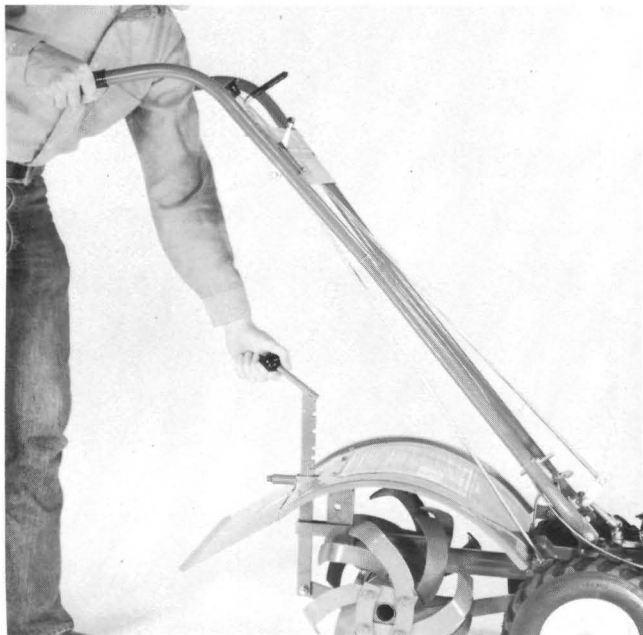

(Photo 2-10) Setting depth regulator

Photo 2-10. With the depth regulator all the way down (engaged in the top notch), the tiller is in "travel" position, and the tines clear the ground by about 1½" — see Photo 2-11 — and the tiller can be moved without damage to the lawn. The lowest notch (on your Pony, that's the sixth notch down from the top) provides for the deepest penetration of the tines, about six to eight inches in depth depending on the soil conditions. See Photo 2-12.

NOTE: When starting up the tiller, the depth regulator should be kept in the travel position with the tines clear of the ground — this for safety's sake.

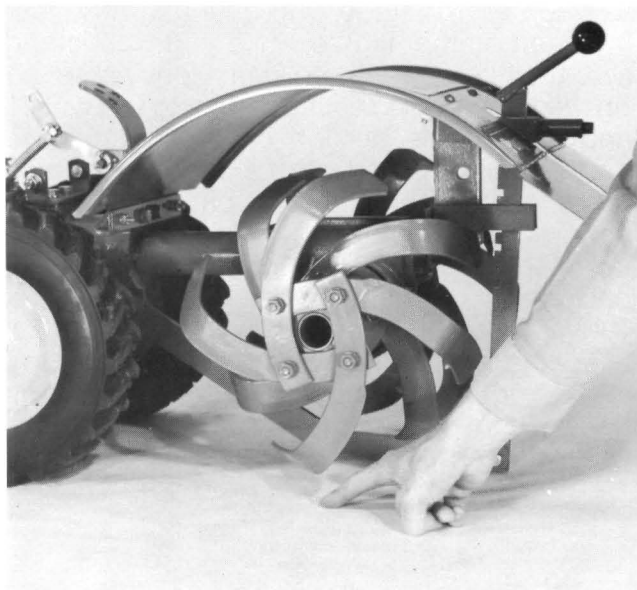

(Photo 2-11) Travel position, tines off floor.



(Photo 2-12) Deep tilling

HANDLEBAR HEIGHT ADJUSTMENT—This T-bar clamp is located near the bottom of the handlebars. The T-bar clamp fastens the crossbar near the bottom of the handlebar to the height adjustment bracket—see Photo 2-13. If you want to make a change, remove the T-bar clamp, and line up the crossbar with another hole and tighten the threads.

The function of the handlebars is to enable you to control and to guide your tiller.

You don't need to exert pressure or weight on the handlebars while you are tilling. Your Pony Model Troy-Bilt Tiller is designed to till as deep as you need with only a lightly guiding hand on the handle while you walk alongside the tiller. See Photo 2-14. Heavy pressure on the handlebars results in raising the wheels and placing the burden of driving the tiller on the tines instead of the wheels. You may feel that you need to hold onto the handlebars with two hands in unworked soil to prevent sudden lurches from changing the balance or direction of the tiller. See Photo 2-15. This would only last until you have tilled the soil well enough to bring up large rocks, roots and other underground obstructions. Then, you should be able to till easily with one hand.

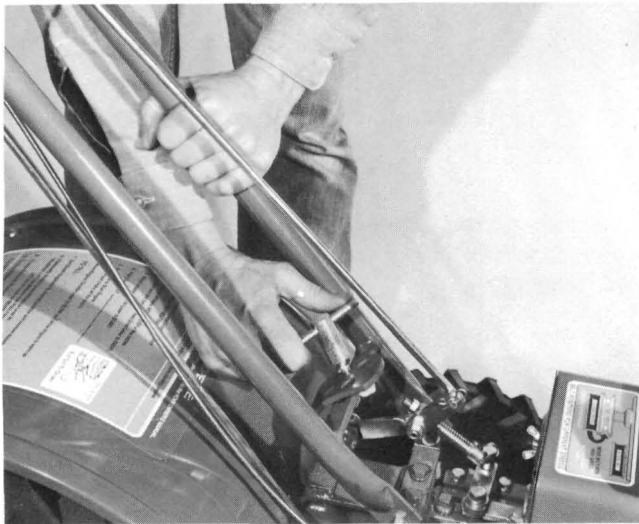

(Photo 2-13) *Handlebar height adjustment*



(Photo 2-14) *Can be lightly guided with one hand.*



(Photo 2-15) *In unworked soil with large hidden stones, use two hands until stones are cleaned out.*

SECTION 3 – SAFETY



SAFETY PRECAUTIONS FOR THE OPERATOR—All power equipment has to be powerful enough to do its job in the garden. Such power, however, can hurt you if you forget or disregard “common sense” safety practices in normal operation.

Please remember to follow the basic safety rules listed below. Each is simply a matter of common sense, based upon knowledge of and familiarity with operating controls of the tiller and the engine.

Please be sensible in how you use your tiller and keep these safety precautions in mind.

BASIC SAFETY RULES—Know your tiller and its engine. Please don't operate your Pony Model Troy-Bilt Tiller without first reading the pages in **Section 2, Tiller Controls**; **Section 3**, these two pages; **Section 4, Engine Controls**; and **Section 5, Tiller Operation**.

1. Study instructions and photos first: Be sure you know which controls do what before you begin.

2. Practice operating controls and running tiller (with tines out of the ground) *before* you start to till.

3. Don't wear loose clothing. It might get caught in moving parts of the tiller or its engine such as tines, belts, pulleys, tires, or shift linkages.

4. Keep hands and feet away from the tiller tines, belts, pulleys, and wheels while the engine is running.

5. Don't let children use the tiller.

6. If you lend your Troy-Bilt to someone else, be sure to instruct him on proper use of the tiller, including safety precautions, before letting him operate it.

7. Don't till near underground electric cables, pipes, or hoses.

8. Make sure that you wear good sturdy shoes. Never till in bare feet or sneakers.

RULES FOR OPERATING AND ADJUSTING THE TILLER—

1. Shut off the engine before cleaning the tines or tiller, or before making adjustments or repairs.
2. Always keep the flap on the tiller cover down when your tiller is operating except when furrowing.
3. Do not engage powered tines in the ground when the wheel drive is in FREE WHEEL. You may not be able to hold it back, and the tiller may travel rapidly away from you.
4. Don't try to till on a hill that is too steep for safety.
5. Please remember: You can **ALWAYS STOP tiller motion** by moving the Forward/Reverse Lever into NEUTRAL.

3



SAFETY RULES FOR OPERATING THE ENGINE—

1. To prevent accidental starting, remove the spark plug wire and tuck the boot between two fins in the cylinder head cover (see Photo 4-8).
2. Always make sure that the Forward/Reverse Lever is in NEUTRAL and the Wheel Drive Lever is in DRIVE, when starting the engine.
3. Do not run the engine in an enclosed area. Exhaust gases contain carbon monoxide, an odorless and deadly poison.
4. Do not fill the fuel tank while the engine is running or hot. Spilling fuel on a hot engine could cause a fire or an explosion. Keep matches, cigarettes, or electrical sparks away from fuel.
5. Allow a hot engine to cool before refilling the fuel tank.
6. Don't touch a hot muffler. Remember to keep your head or arms away from it while working with the universal assembly or other tiller parts.
7. You can STOP the ENGINE by **pulling the engine throttle control back to STOP**.
8. Don't touch battery terminals with metal tools, jewelry, watches, or other metal such as a fuel can. A spark from shorting it out could cause an explosion of battery gases or gasoline.

SECTION 4 – ENGINE CONTROLS AND OPERATION

Your Pony Model Troy-Bilt Tiller has a Five Horsepower Briggs & Stratton gasoline four stroke cycle engine — it's either Model No. 130292 (Recoil Start) or Model No. 130297 (Electric Start). PLEASE DO NOT MIX OIL WITH GASOLINE. Motor oil goes in the crankcase oil fill hole. Read your owner's engine pamphlet thoroughly to become familiar with your engine and its controls. The information in this section applies specifically to your engine model.

If you require engine service you can locate

an authorized Briggs & Stratton Service Dealer in the "Yellow Pages" of the telephone book under Engines — Small, or Engines — Gasoline. He is one of 25,000 authorized dealers available to serve you. The engine service dealer will need the following engine numbers to properly identify parts for it. If you have a Recoil Start: Model — 130292; Type — 0793-01; and Code, a number such as 77080510. If you have an Electric Start: Model — 130297; Type — 0782-01; and Code, a number with eight digits.

Your engine is warranted by the engine manufacturer for one year from the date of delivery of your tiller. Any repair work done on your engine by unauthorized persons will probably void your warranty.

ENGINE THROTTLE CONTROL — The engine throttle control (on the operator control panel) provides you with control of engine speeds. The engine throttle has a full range of speeds and has four positions identified. They are: STOP, SLOW, START and FAST.

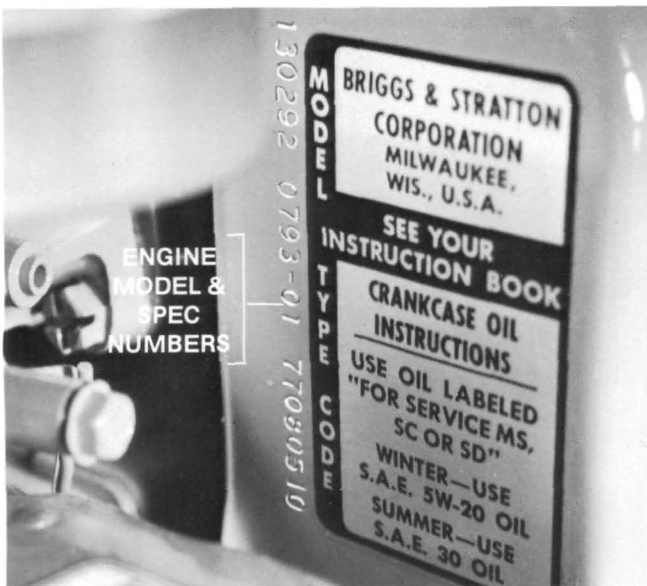

(Photo 4-1) Numbers are stamped in metal.

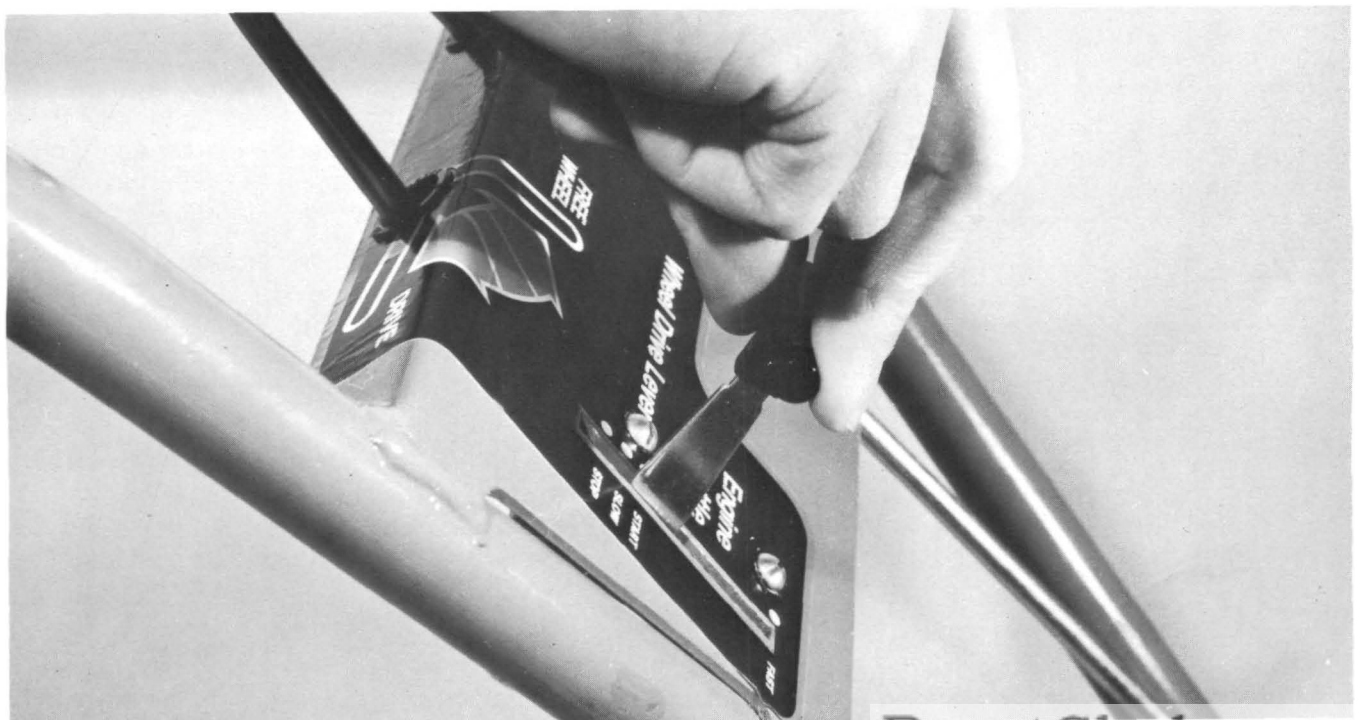

(Photo 4-2) Engine Throttle Control

In the START position, (see Photo 4-2) sufficient flow of gasoline is provided to the carburetor to start the engine. **Starting the engine always requires the use of the manual choke—even when the engine is hot—see information below on “Choke.”** The choke provides the engine with a richer fuel-to-air mixture for starting.

After the engine has started, the choke must be pushed back in promptly. Then, the engine needs to warm up, preferably at slow speed.

FAST throttle speeds up engine operation and it increases tine rotation and wheel speeds. You'll need fast speed for tilling sod under to make a new garden, or to enlarge your present one. Also, use a fast throttle setting for tilling in cornstalks, high weeds or dense crop residues or cover crops. Only use as fast a throttle setting as is needed to do the job. Seek out the setting that gives you sufficient power to do the job, but no more!

When you move the throttle lever to the STOP position, a shutoff switch stops the engine. Photo 4-3 shows how the throttle cable rotates a bright metal plate underneath the shutoff switch and stops the engine.

The stop position on the throttle is another control (besides the Forward/Reverse Lever) that can be used to stop all engine and tiller motion.

CHOKE—The choke is located near the top of the right side of the engine, just beneath the air cleaner. When it is pulled out, (see Photo 4-4) it cuts off most of the air supply to the carburetor to provide the rich mixture required for starting the engine. As soon as the engine starts, push the choke back in (see Photo 4-5) to increase the air supply to the carburetor required for a leaner running mixture. If you fail to do this promptly, the engine will stall out.

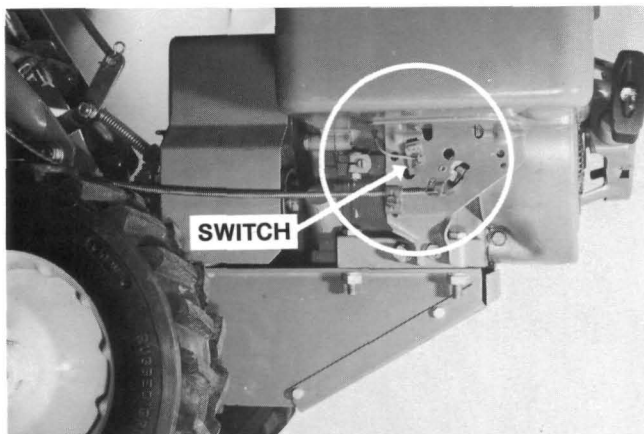

(Photo 4-3) *Engine Shutoff Switch is located beneath gas tank where lower end of throttle cable is connected. The electric start Pony has a second wire that leads to the Key Switch.*

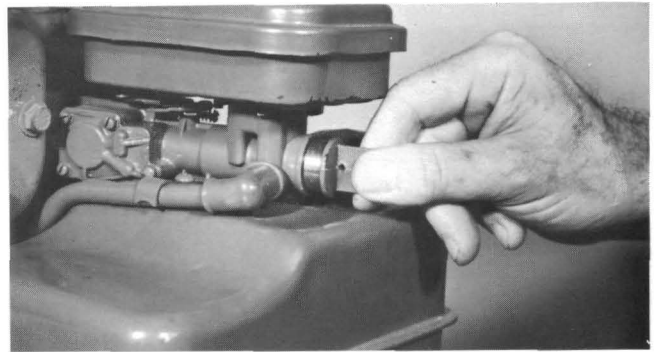

(Photo 4-4) *Pull choke out every time when starting.*

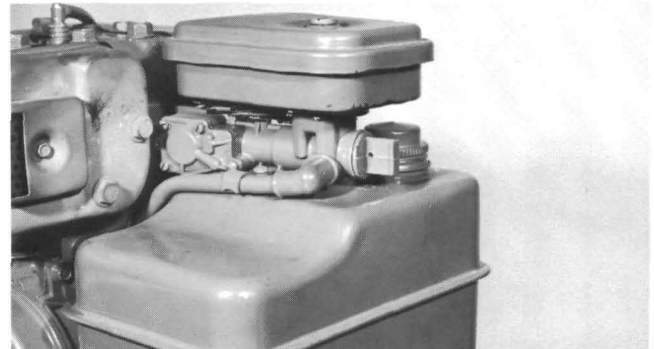

(Photo 4-5) *After starting, push choke in.*

SHUTOFF SWITCH — The engine shutoff switch works automatically when the engine throttle control is moved to the STOP position on the operator's control panel—see Photo 4-3. To guard against accidental starting of the engine remove the spark plug wire and stick the rubber boot between two cooling fins on the engine top—see Photo 4-8.

BEFORE STARTING THE ENGINE — Check the crankcase oil level each day (see Photo 4-6) — with tines in the travel position at top notch to keep engine base level. The crankcase oil level must be maintained at full to the point of overflowing. (See Section 1, Easy Assembly, for procedure for adding oil to the crankcase. The oil should be classified for SE or SF service and should be #30 viscosity.

Also, before starting the engine each day check the air cleaner—see Photo 4-7. Checking, cleaning, and re-oiling the air cleaner are covered under **Air Cleaner** in **Section 6, Maintenance of Tiller and Engine.**

Also, make sure that:

- The gas tank is full of regular grade gasoline (use leaded or low-lead, but not unleaded)
- The Wheel Drive Lever is in DRIVE
- The Forward/Reverse Lever is in NEUTRAL

ENGINE OIL—Check oil level each day and also after each five hours of operation if you are tilling all day. Change motor oil after the first five hours of operation and thereafter every 10 hours. See **Section 6, Engine Maintenance** for details on oil changes.

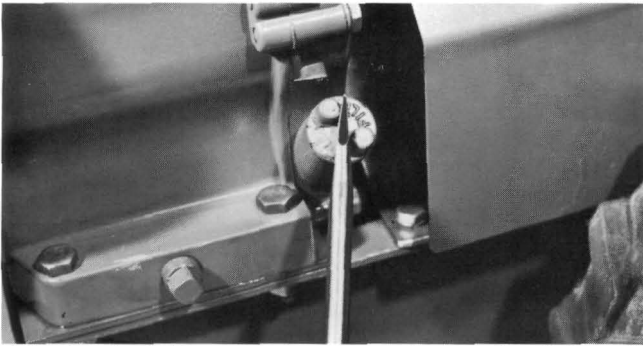

(Photo 4-6) Remove cap and check oil level.



(Photo 4-7) Inspect air cleaner.

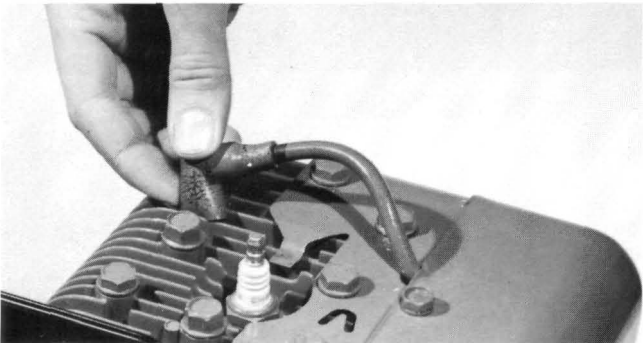

(Photo 4-8) Tuck boot between fins.

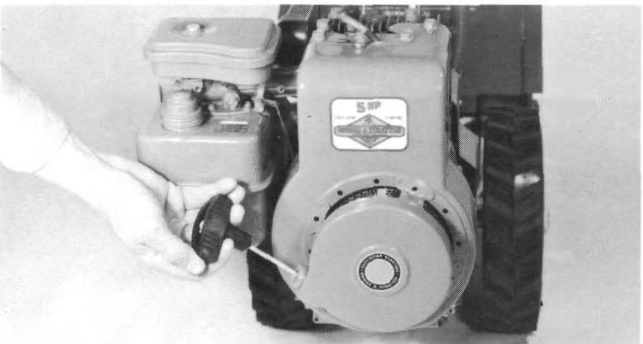

(Photo 4-9) Pull out cord to start engine.

AIR CLEANER—The air cleaner should be checked every time the tiller is used. In hot, dry, and dusty conditions, the engine manufacturer recommends that it be checked every few hours, we certainly agree. See **Section 6** for details.

CAUTION: A properly serviced air cleaner protects the internal parts of the engine from dust particles in the air. If air cleaner instructions are not carefully followed, the dirt and dust which should be collected in the cleaner

will be drawn into the engine and can quickly damage your engine.

STARTING YOUR PONY THE FIRST TIME

If you've followed all the instructions to this point, leaving out nothing, you're ready to start the engine the first time. Here are the starting steps.

1. PULL THE FORWARD/REVERSE LEVER OUT AND LET GO OF IT TO FIND NEUTRAL. IT MUST BE IN NEUTRAL.

2. Engage the wheels. ROLL TILLER a few inches while turning the Wheel Drive Lever to **DRIVE**.

3. Move Engine Throttle Lever to START Position as marked on the operator control panel on the handlebars.

4. Pull out choke—see Photo 4-4 on Page 26 of your Owner's Manual.

5. Manual Start Models—Grasp the starter handle and slowly pull the cord until you feel resistance (Photo 4-9). Then pull the cord out rapidly . . . but let it back in slowly.

Electric Start Models—Make sure the throttle lever is not in "shutoff" position. Insert your key in the slot—all the way—and turn it to **START**. Hold it at start no more than 10 seconds. The first time starting though, you may try this several times before the engine catches. When the engine starts, release it . . . the key will automatically return to **RUN**.

6. Push the choke all the way in, and move the Engine Throttle Lever to SLOW, allowing the engine to warm up.

The decal on the hood of your Pony gives instructions on how to start the manual model. You can start the electric model with the recoil start rope, but only after you follow the steps described in "IN CASE OF A DEAD BATTERY" in "Troubleshooting," Section 6.

STOPPING YOUR PONY'S ENGINE THE FIRST TIME

Stopping the engine is just as important as starting it . . . maybe more. Your Pony's engine can be "shut off" two ways: with the throttle lever or with the key switch. Here's how to stop it . . .

1. Pull out the Forward/Reverse Lever and let go to find NEUTRAL.

2. Put throttle lever back to STOP. This should stop the engine in a couple of seconds.

3. Turn the key to OFF (if you have an electric).

4. If you have an electric start, remove the key for safekeeping. (We suggest you keep the spare key in an easily found place, but secure from children, who aren't supposed to use the tiller.)

SECTION 5 – TILLER OPERATION

5



(Photo 5-1) *Tilling the Troy-Bilt way with tines in the rear.*

You should now know where the Pony Model Troy-Bilt Tiller controls are and how they work, and you should now be ready to use your Pony to chop up, shred, and bury all sorts of organic matter like crop residues, mulches and cover crops as well as use the Pony to cultivate the garden (Photo 5-1).

YOU MUST USE THE SOD POINT

The Sod Point is absolutely essential for proper operation. It helps the powered wheels control the forward motion of your Pony, allowing the tines to do their job better and giving you very positive control of the tilling. The Sod Point attaches to the drag bar (see Section 1) and please put it on before you start to till. You'll find it helpful almost all the time, especially so in unbroken sod; compacted or rocky soil, or clay.

The Sod Point should be attached to your tiller's drag bar (see Photo 5-2) almost all of the time. There are really only two exceptions to this: 1) when you are cultivating and want to till only very shallowly so as not to harm crop roots; 2) when you wish to till extra deep (taking the Sod Point off in this case may allow the tines to dig another two inches deeper). When not using the Sod Point, make sure you store it, along with the locknut and bolt, right with your most important gardening tools.

Ordinarily, you would put the Sod Point on

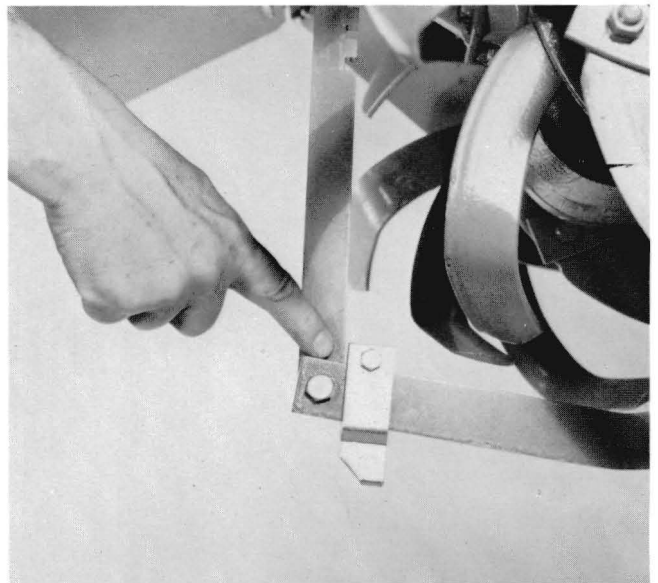

(Photo 5-2) *Mount flush to depth bar and tighten.*

the drag bar with its straight edge forward as shown in the photo. However, while tilling mulches and some cover crops you might want to turn the beveled edge of the sod point forward to reduce the amount of buildup of crop residue on the sod point.

TO OPERATE YOUR PONY—The instructions on your tiller hood are a summary of the steps to follow to operate your tiller.

BrentChalmers.com

1. PULL the Forward/Reverse Lever OUT and LET GO of it to find NEUTRAL—see Photo 5-3.

2. Engage Wheels: ROLL TILLER a few inches while you are turning Wheel Drive Lever to DRIVE—see Photo 5-4.

3. Move the Engine Throttle Lever to START—see Photo 5-5.

4. Pull the choke OUT—see Photo 5-6.

5. Pull start rope to Start Engine—(see Photo 5-7) or turn key to START. Push the choke all the way in when engine starts.

6. Pull the Engine Throttle Lever to SLOW and allow the engine to warm up.



(Photo 5-3) Place lever in Neutral.

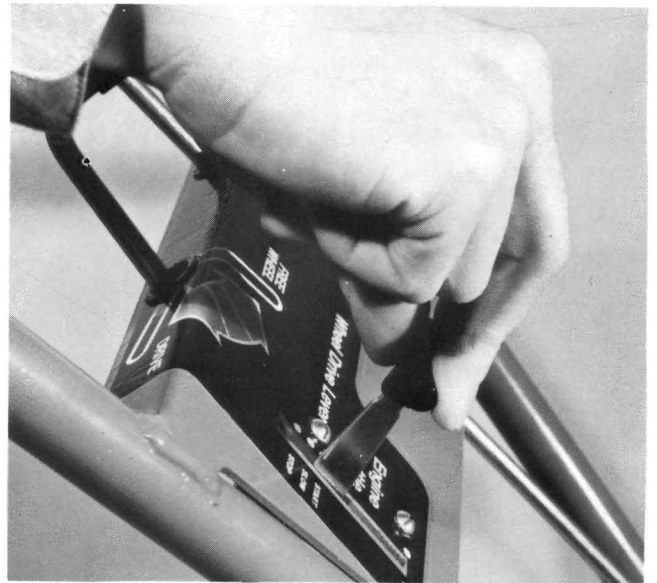

(Photo 5-5) Set engine throttle at Start.

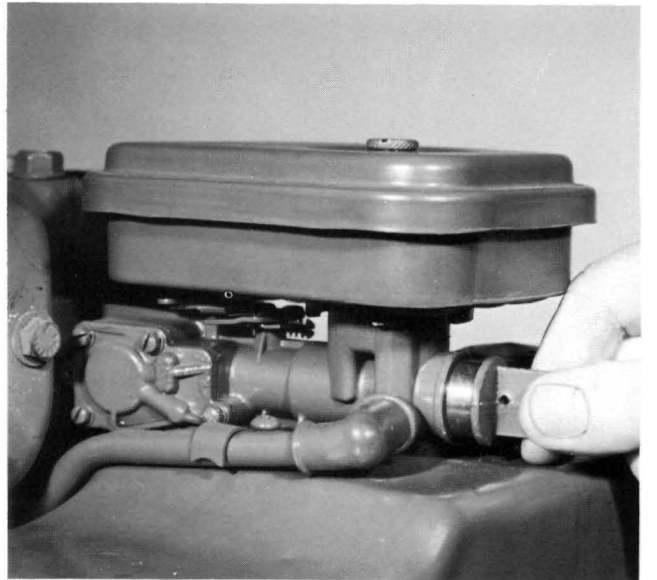

(Photo 5-6) Pull choke out to start.

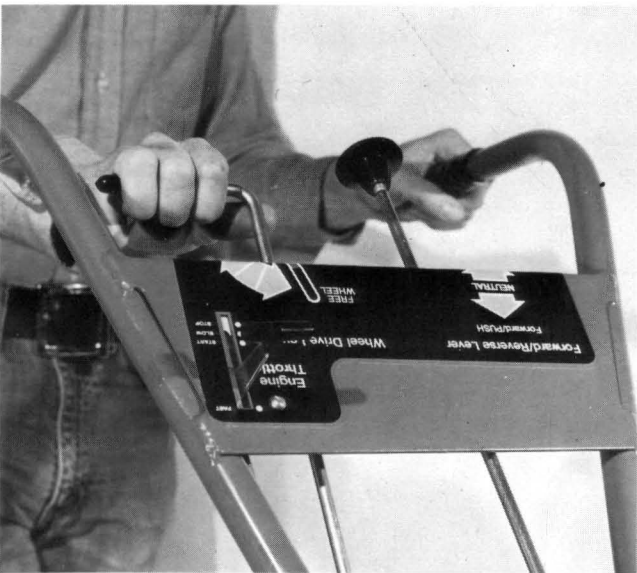

(Photo 5-4) Turn gently to Drive.

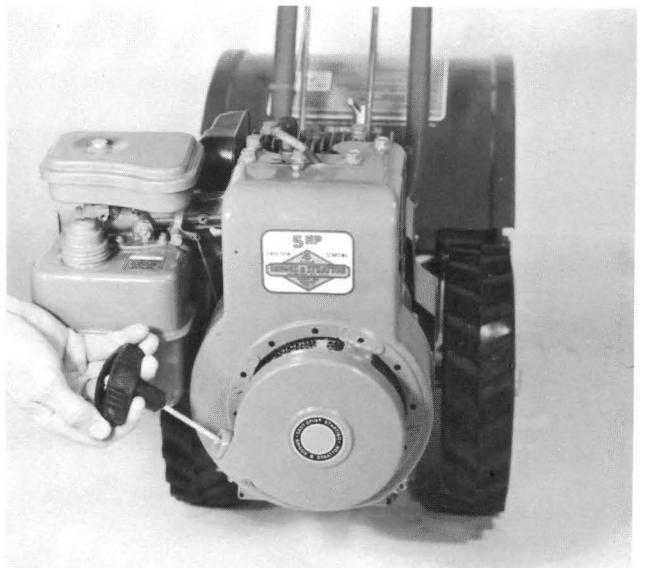

(Photo 5-7) Pull start rope rapidly.

TO TILL

7. Set the Depth Regulator to the desired position and increase throttle speed—see Photo 5-8.

NOTE: In the second notch, the tines will cut into the soil to a depth of about 1½" to 2". It is almost impossible to get down four or five inches into the soil on the first pass through untilled soil. Don't try to go all the way in one pass. Set the depth regulator for a lesser cut and let the tiller do the work while you just guide it.

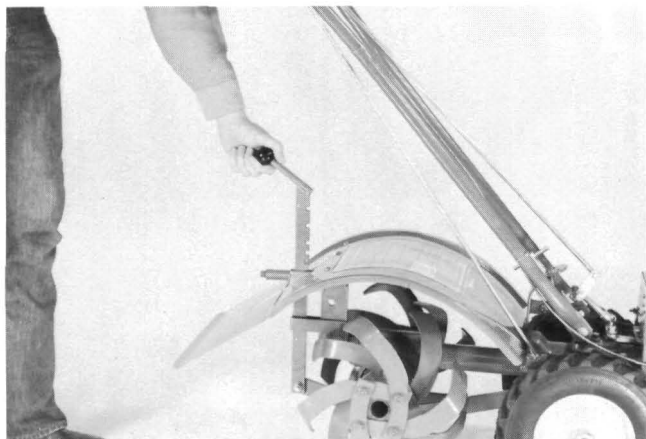

(Photo 5-8) Set depth regulator.

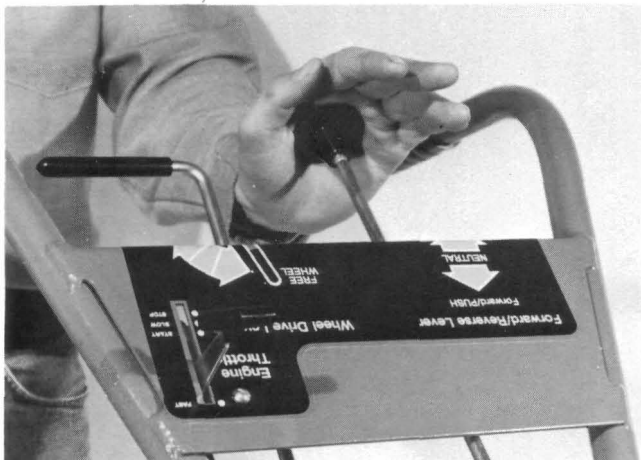

(Photo 5-9) Push IN, to go forward.



(Photo 5-10) For reverse, lift handlebars and pull Forward/Reverse Lever out.

8. FOR FORWARD: PUSH the Forward/Reverse Lever IN. (See Photo 5-9)

FOR REVERSE: LIFT the handlebars to raise the tines, then PULL Forward/Reverse Lever OUT, and HOLD—see Photo 5-10.

LET GO for NEUTRAL. NOTE: You do not till in reverse.

TO STOP

9. To stop the tines and wheels, PUT the Forward/Reverse Lever in NEUTRAL.

10. To STOP the Engine, MOVE the Engine Throttle to STOP.

CAUTION: DO NOT put the tines in SOIL if the Wheel Drive Lever is in FREE WHEEL. The wheels will not perform their function of holding the tiller back, and if the tines are in the soil, they'll propel the tiller very rapidly. Put the Wheel Drive Lever in DRIVE before engaging tines.

Tines revolve when engine is on and Forward/Reverse Lever is engaged.

PLEASE REMEMBER to read the complete turning around instructions before you operate your tiller in the garden.

TILLING IN THE GARDEN

When you start to till in the garden, remember to use the Sod Point and take it easy. Do not try to take too deep a cut in the first pass through sod or hard ground, or soil that has not been tilled for several months or years. Go over the same path twice in the first row, then overlap ½ a tiller width on the succeeding passes—see Sketches 5-24A, B, & C and Sketch 5-25, under **Tilling Patterns**. Some very difficult garden sites, such as ground that hasn't been worked in 20 years, might take 3 or 4 passes before you start to make much headway—follow the pattern in Sketch 5-24B. When tilling on even the slightest slope, make the first passes uphill. In most soils, it's best to start out at the second or third notch of the depth regulator to break through the upper surfaces of the soil. The fastest method is to till as deep as you can without making the tiller jump when it hits rocks, etc., but you should wait until you are very familiar with the tiller's operation before you use that procedure.

NOTE: DO NOT LEAN on the handlebars. This takes the weight off of the wheels, reduces traction, and causes the tines to attempt to propel the tiller instead of just digging.

CAUTION: In your first passes through new or untilled ground, always use the Sod Point. Walk behind the tiller and lightly, but securely grip DrentChalmers.com

the handlebars with both hands—see Photo 5-11. This enables you to keep control of the tiller when it strikes a rock or other obstruction. Later when large stones, roots or other obstacles have been removed, you will be able to walk alongside the tiller and guide it lightly with one hand to avoid making footprints in the freshly tilled ground. Of course, if your soil is free of such obstructions, you will likely be able to guide your tiller with one hand from the outset.



(Photo 5-11) Be sure to use the Sod Point and use two hands, if necessary.

Photos of Tilling Sequence



(Photo 5-12) Before tilling, set the depth regulator — shown in the photo.



(Photo 5-13) Put the depth adjustment bar at the second, third or fourth notch, depending upon soil conditions.



(Photo 5-14) When you have put the Wheel Drive Lever in DRIVE, line up with your row and PUSH for Forward.



(Photo 5-15) If the ground has been well prepared, you can easily walk alongside guiding your Pony with one hand.



(Photo 5-16) Women find the Pony easy to handle.

BrentChalmers.com

TURNING YOUR TROY-BILT PONY

TURNING AROUND

When you reach the end of a row, throttle down the engine and lift the handlebars to raise the tines out of the ground. See sequence of Photos 5-17 through 5-22. Tilt the tiller forward far enough to gain an easy-to-handle balance before starting your turn. Tines are usually seven to ten inches off the ground at this point. To make the turn—holding the handlebars up to balance the weight

—push the handlebars to the right (or left) so the tiller will turn in the direction you wish. It takes little effort to swing the tiller around. The wheels drive your tiller and do most of the turning.

As you can see after you have tried it in the garden, turning your tiller around is simple and very easy. All you need do is get used to controlling the balance using the wheels

5



(Photo 5-17) Reduce throttle setting and raise the tines out of the soil.



(Photo 5-18) Balance the weight of the engine in front with the tines in the rear. Use your arms to push the handlebars sideways to move the tiller in the direction of your turn.



(Photo 5-20) Turn the Pony to the next position.



(Photo 5-22) Use reverse to turn in close quarters: keep handlebars up; balance tiller weight; and PULL out on the Forward/Reverse Lever to back up briefly. This allows you to complete your turn in a small area.

AROUND

as the pivot point and letting the power driven wheels do the work.

Both wheels of your tiller turn at the same rate of speed because solid-axle design provides them equal power. The wheels also hold the tiller back while the tines are digging, one of the most valuable features of your Pony Model Troy-Bilt Tiller.



(Photo 5-19) *Let the wheels do the work as you guide your Troy-Bilt around.*

TILLING PATTERNS

By going up and down rows and overlapping each time, you can break up all the soil with minimum effort — see Photo 5-23 and Sketch 5-24A. By making a second pass at a right angle across all of your previous passes, you really pulverize the entire garden area with your tiller — see 5-24B. For cultivating, see 5-24C.

If your garden is not wide enough to till lengthwise and then crosswise, you need a method of overlapping which makes sure that all of the soil is thoroughly broken up for planting. For tilling long, narrow strips—see Sketch 5-25. Overlap the second, third and fourth passes half a tiller width over the previously tilled path, then overlap one-fourth a tiller width on successive passes back over the freshly tilled ground.

Whenever you are tilling vertically on the slightest slope, try to make the first pass uphill. Your tiller digs in much more deeply going uphill than it does downhill. This is especially helpful when tilling under sod or cornstalks.



(Photo 5-23)

(Sketch 5-24) A, B, C

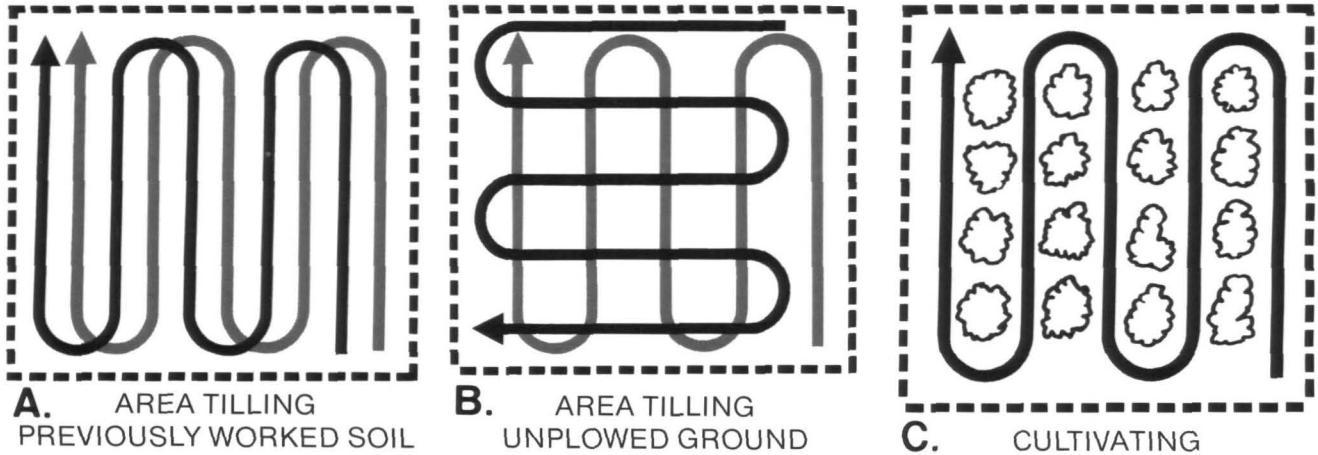

5

TILLING NARROW STRIPS

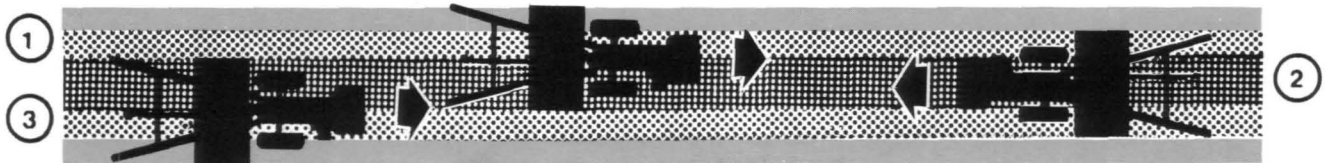

(Sketch 5-25)

OVERLAP 1/2, THEN 1/4.

DON'T MAKE FOOTPRINTS

When making your final passes in a garden section at the desired depth, walk alongside the tiller on the side that is not yet finished — see Photos 5-26 and 5-27. You can easily guide the tiller with one hand, leaving no footprints in the path that you have just tilled.

Eliminating footprints contributes much more than just good appearance to your garden. It aids in preventing soil erosion and avoids “planting” unwanted weed seeds and plants right back in your garden bed.



(Photo 5-26) Don't leave these marks.



(Photo 5-27) Walk on untilled side, guiding tiller with one hand.

UNWINDING TINES

Wherever high growth of dried-out rye grass, stringy stalks, or hardened vines occur there is some tangling of crop residues among the tines. When this happens, lift the tines out of the soil, PULL the Forward/Reverse Lever back to NEUTRAL, and then into REVERSE for a few feet. This reverses the direction of the tines' motion and unwinds a good deal of the debris. Then PUSH the Forward/Reverse Lever into FORWARD and go on tilling again.

It is not necessary to remove all crop residue that winds around the tines during tilling, but don't let it build up to a point where it chokes off action of the tines. Before this happens, try reversing the tiller to unwind and reduce the amount of tangling. If that fails, STOP the tiller and the engine, put the Forward/Reverse Lever in NEUTRAL, and clean the debris out.

WARNING: For safety's sake, stop the engine entirely before unwinding the tangled material by hand.

A small pocket knife, or a linoleum knife, can be helpful in cutting loose some of the tangled material faster, but there should only be a minimal amount of tangling.

BOLO TINES

Bolo tines are standard equipment on your tiller — see Photo 5-28. They are the best all-purpose tines for all soil conditions. They are used for tilling sod, weeds, cover crops, crop residues, composted material, mulch materials and for preparing seedbed. They are excellent for cultivating at high or low speed. Bolo tines will till to a depth of 6 to 8 inches, or more.

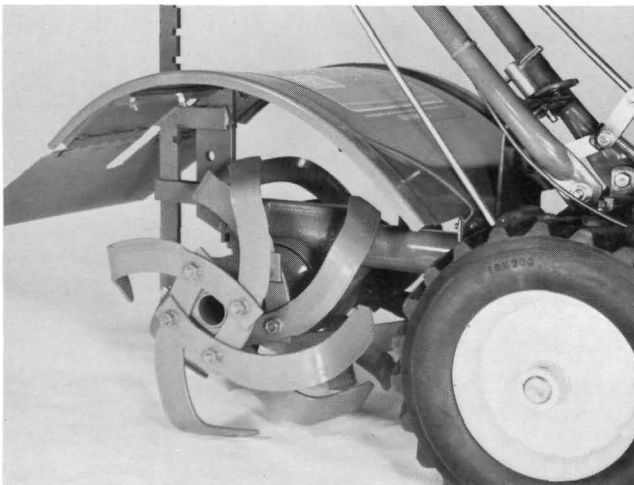

(Photo 5-28) *Bolo tines*

Bolo tines have a self-cleaning action which just about eliminates all but a small, bearable amount of tangling.

MATCHING WHEEL AND TINE SPEEDS TO PARTICULAR JOBS

With a little experimenting, you can soon find the proper tilling depth, wheel and tine speed which is just right for the piece of soil you are working on. What this means is:

1. You advance the throttle lever on the handlebars to keep the engine running at a sufficient power level to do the job.
2. You have the depth regulator set in a notch which is not so deep that it causes the engine to labor or causes the tiller to jump.
3. You have the tines turning over fast enough to really break up the soil with a minimum of passes.

When your tiller is working properly, you can hear that the engine is not laboring very hard and see that the tines move well and break up the dirt into small, pulverized bits. At the proper match of wheel and tine speeds, you get the job done quickly, more effectively and achieve results which are better and more satisfying.

TILLING UP AND DOWN SLOPES

If you garden on a slope, your tiller can be the greatest benefit to you if you are able to plant rows up and down the slope. You can move the belt to the high speed position to till up the slope in high speed—see "Changing from Low to High Speed," later in this section.

In soft soil or weeds, you may have to lift the handlebars up slightly as you go uphill. Till uphill on the first pass. It does a better job than going downhill. The powered wheels of the Troy-Bilt pull the tiller up the hill to do your digging and also hold the tiller back while you go downhill to prevent the tiller from going too fast.

Tilling vertically on a slope permits you to prepare the entire area for your seedbed as well as to provide enough room between rows so that you can cultivate between them during the growing season—see Photo 5-29. Growing a garden vertically on a slope does not involve much of a problem with soil erosion, as long as you put in enough organic material to improve the moisture holding ability of your soil and do not leave footprints or wheelmarks. Soil in this condition

is broken up enough to prevent packing, and is held together well enough by those organic materials so that it readily absorbs water.



5 (Photo 5-29) Vertical tilling on slope builds up your soil and improves its ability to absorb water by power composting and cultivation. Use of staked-out row markers saves time and effort. Shown in photo is the Horse Model Troy-Bilt.

Tilling vertically up and down a slope allows you to make tilling passes while walking alongside the tiller, with one hand controlling the tiller. Walking alongside eliminates troublesome wheelmarks and footprints which are likely to cause erosion and gullies on a slope.

Tilling uphill and downhill also enables you to cultivate between crop rows with your tiller instead of the hand-cultivation likely to be required if you terrace across a slope.

UPHILL TILLING NOTE

IMPORTANT: Make sure that you check your engine oil level every day and bring the oil up to the point of overflowing from the Oil Fill hole. Constantly watch the engine oil level while tilling up a slope.

When tilling at the deepest setting of the depth regulator and going UP a steep hill, the oil slants away from its normal position because you seriously increase the incline of your tiller's engine. The engine's operation depends upon its ability to splash oil on moving parts for lubrication and for prevention of overheating from friction, or bearing surfaces from "burning out" from lack of oil. The engine's oil dipper is not able to reach the oil unless its level is kept properly up to the top of the Oil Fill hole. It is absolutely necessary.

When you are tilling across a hill or downhill, you need to exercise normal precautions about engine oil levels, but need no more concern than when tilling on level ground.

TILLING ACROSS SLOPES

Whenever a slope is too steep or too short for vertical tilling, it may be necessary to till across the slope laterally. First, make sure that the slope is not too steep to till safely at all. The best way to achieve good results tilling across the slope is to create terraces for your garden.

In three or four passes, your tiller can carve out a flat and wide enough terrace for planting — see Sketch 5-30.

Start to terrace on the top of the slope and work down. Each succeeding lower terrace is started by walking below the terrace you are preparing. This puts you at a level where you can control the tiller. Make sure that you don't till the last foot of the outer edge of the terrace. The tiller covers this edge up with soil, but don't till it! Keeping the soil underneath the edge unbroken, prevents terraces from breaking apart and washing downhill.

Terraces should be formed by tilling a swath three to four feet wide. This width on a slope means that there may not be enough room to use the tiller for cultivating. You can prepare a seedbed for two rows of plants with the tiller and till under crop residues, but you'll have to cultivate by hand by walking along the inner edge of the terrace below.

TILLING ACROSS SLOPES WITHOUT TERRACES

Tilling across the slope without forming terraces is not recommended, but it can be done. Begin at the top of the slope and overlap half of each tilled path, always keeping the *uphill wheel* in the soft, newly tilled soil. Doing so will help you keep the tiller more stable across a relatively steep slope.

Before trying to till in this manner, or creating terraces across a slope, please think it over carefully and see if it isn't possible to till vertically up and down a slope; many people have done it quite successfully.

THREE THINGS WORTH REPEATING—The secret of tilling success with your Pony Model Troy-Bilt Tiller depends on these three things:

1. Start your cut shallow. Don't try to go all the way down in one pass. Set the Depth Regulator and let the tiller take over. It does the work.

TERRACING IN 3 PASSES

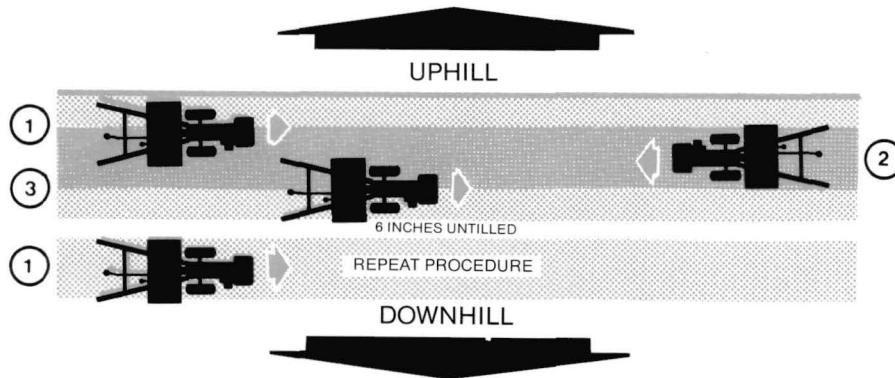

(Sketch 5-30) *Creating a terrace in three passes.*

2. Set the Engine Throttle control to give the engine sufficient power to operate at the slowest possible speed . . . at least until you have achieved the maximum depth you want. Faster engine and wheel speeds may be desirable to break up the last bits when you are making final passes through a garden, or when you are cultivating—see Photo 5-31.

3. Avoid the temptation to push down on the handlebars. When you push down on the handlebars, the wheels lose traction and the tiller can hop and skip across the garden.

The wheels power the tiller in forward or in reverse. The wheels turn much slower than the tines, thus holding the tiller back while the separately geared tines dig. In normal low speed, the tines turn about ten times faster than the wheels, allowing the tines sufficient time to catch the soil below and the clumps already broken up which are still within the tiller cover and to break them all up into tiny fragments. Avoid the temptation to lean down on the handlebars; you defeat your own purpose.



(Photo 5-31) *Tilling in buckwheat is easy.*

CHANGING TILLER SPEED — Your tiller comes to you with the belt in the low speed groove of the forward pulley—see Photo 5-32. Low speed is best for heavy tilling jobs. With the belt in high speed groove, faster speeds may be achieved for: moving your tiller to and from the garden; cultivation; tilling in well-broken ground; or breaking up the last bits in final passes. To change the forward speed from low to high, follow the directions on the next page (the different positions are shown on a decal on the belt cover).

WARNING: Do not remove the cover for the belts or pulleys or attempt to change tiller speeds, make adjustments of the belts or pulleys while the engine is running. Stop engine, disconnect spark plug wire and tuck the boot in between two fins on top of the engine.

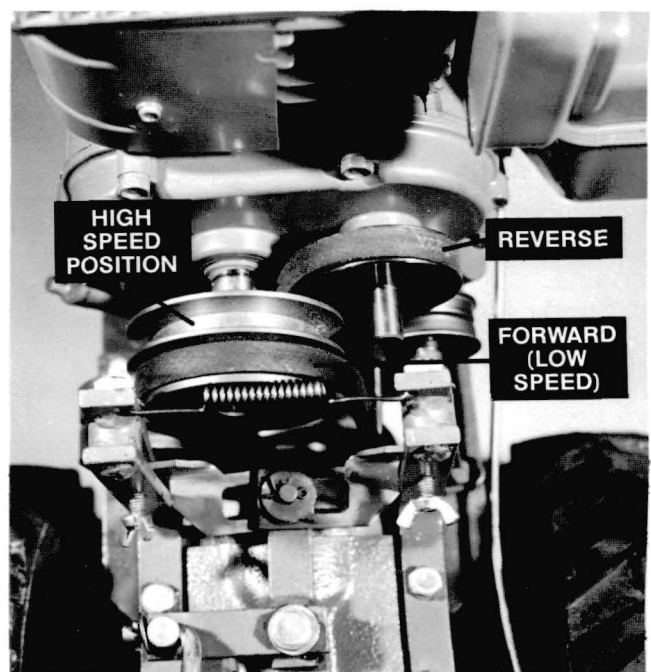

(Photo 5-32) *Pulley drive belts.*

CHANGING FROM LOW TO HIGH SPEED

- Disconnect spark plug wire (see Photo 4-8)
- Remove the belt cover by loosening (but not removing) the two wing nuts.
- See Photo 5-32 to locate the Forward Drive Belt

Step 1 Kneel by the right side of the tiller (same side as throttle cable), and slowly pull on the starter recoil cord, while working the belt out of the low speed groove with your fingers, as shown in Photo 5-33. BUT, be careful of your fingers on the belt when you pull the starter rope. The pulley's rotation will help unseat the belt.

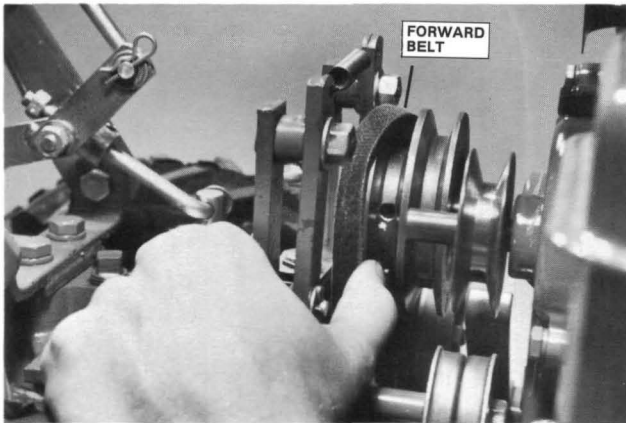

(Photo 5-33) Work belt out of groove while pulling starter cord.

Step 2 When the belt is out of the groove—practically off the upper pulley—there will be enough slack to move the belt downward and forward on the lower pulley. Do this by reaching underneath to the lower pulley and shifting the belt to the high speed groove, which is the middle groove on the lower pulley. See Sketch 5-34 and Photo 5-35.

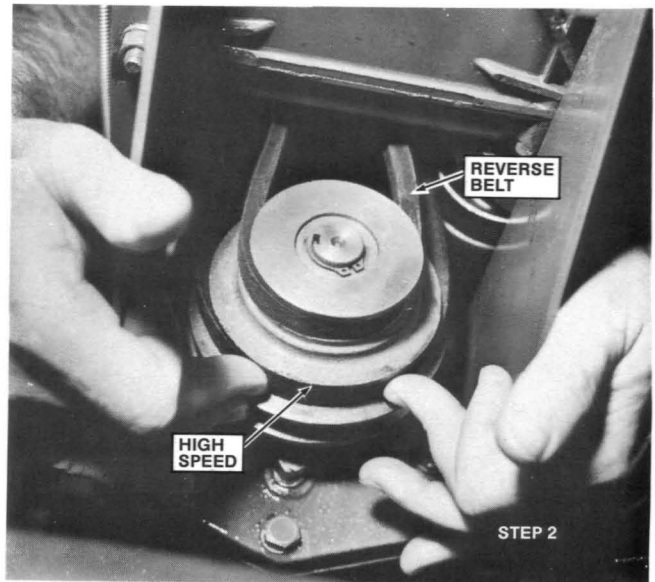
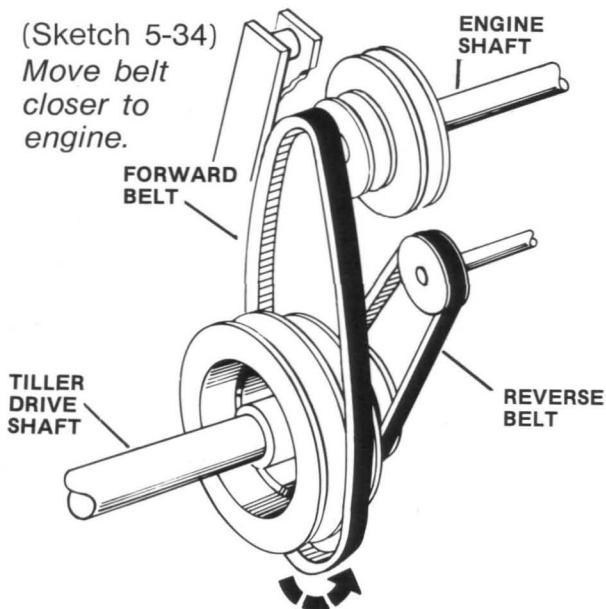

(Photo 5-35) Reach underneath tiller just behind engine, locate lower pulley with your hands and seat belt in middle groove.

Step 3 Now go back to the top pulley. Seat the belt in the high speed groove on the fuel tank side of the tiller as shown in Photo 5-36. Pull the starter recoil rope so the pulley rotation will seat the belt. Replace the belt cover and reconnect the spark plug wire.

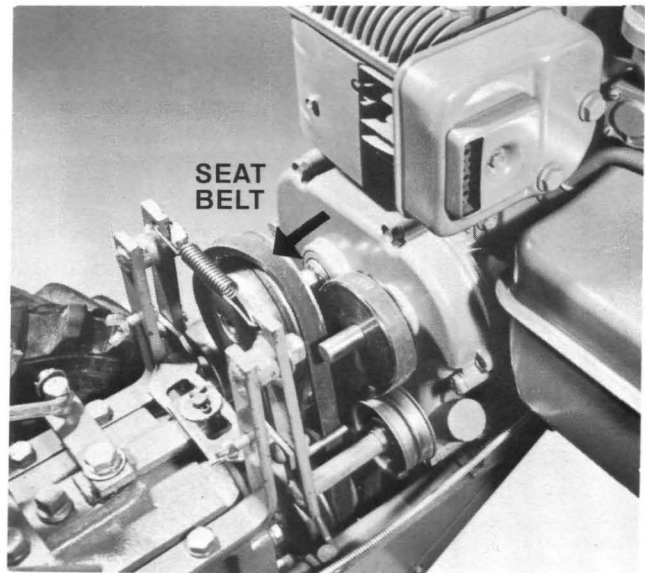

(Photo 5-36) Seat belt by pulling cord.

CHANGING FROM HIGH TO LOW SPEED

- Disconnect spark plug wire (see Photo 4-8)
- Remove the belt cover by loosening (but not removing) the two wing nuts.
- See Photo 5-32 to locate the Forward Drive Belt

Step 1 Kneeling by the right side of the tiller, work the belt out of the high speed groove by pulling with your finger while you slowly pull on the starter cord. When the belt is out of the groove, as shown in Sketch 5-37, there should be enough slack so you can push the belt downward, creating slack down around the transmission pulley.

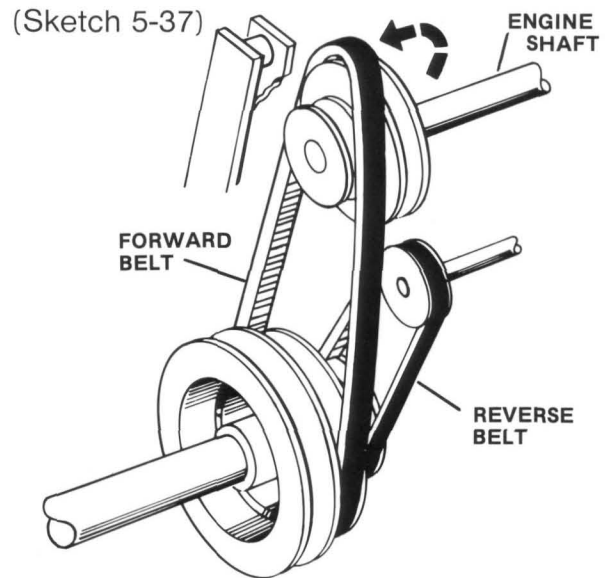

Step 2 Reach underneath to the transmission pulley and move the belt one groove toward the transmission: that is the low speed groove. Feel to see that the belt is seated all around the groove.

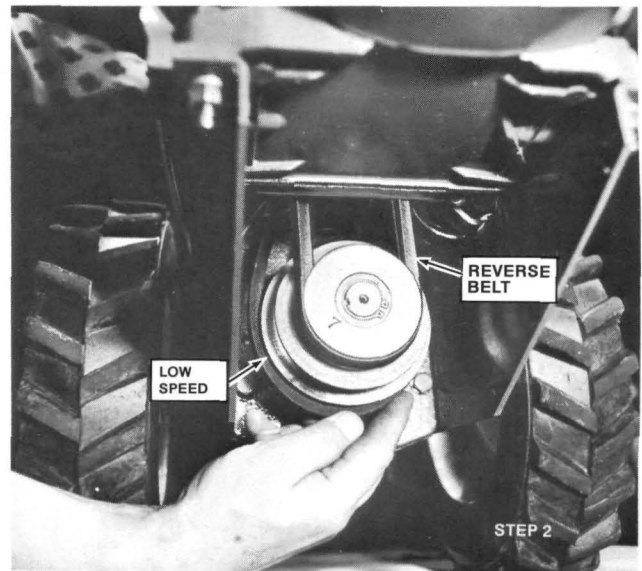

(Photo 5-38)

Step 3 Now, go back up to the top pulley and seat the belt in the low speed groove on the fuel tank side of the tiller (right side from operator position) as shown in Sketch 5-39. With the belt partly in the pulley groove and spark plug grounded, simply pull the starter rope a few inches and the belt should seat itself. Replace cover, tighten wing nuts and reconnect spark plug wire.

If you wear your belts out, you'll receive complete instructions on how to remove and replace your belts with your new parts.

(Sketch 5-39)
Partially seat belt, pull rope.

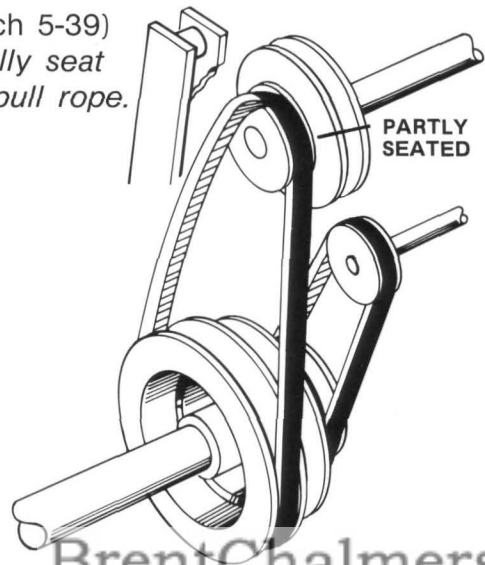

HOW TO TIGHTEN THE FORWARD DRIVE BELT

If you notice the forward drive belt slipping, squealing, or that the engine speed and sound stay the same while the tines slow down, you may want to adjust the tension on the idler pulley for the belt. To do this, put the Forward/Reverse Lever in Neutral. Use a 1/2-inch wrench and loosen the locknut until it's near the top of the connecting rod in order to relieve the spring tension (see Photo 5-40).

Now, take a 1/8-inch hex wrench and loosen the set screw in the adjusting collar (also shown in Photo 5-40). Using a screwdriver for leverage, pry the adjusting collar up approximately 1/16-1/8-inch. Hold it in this position while you securely tighten the set screw. Don't tighten it too hard because it has a soft tip for better holding power. Last, move the locknut down to its original position on the connecting rod. If the slipping persists, repeat this process to put added tension on the idler pulley.

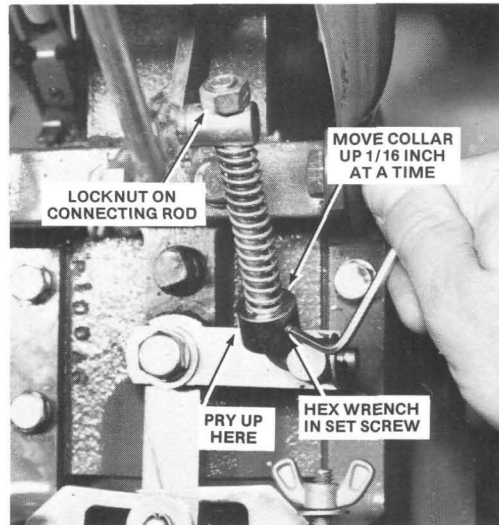

(Photo 5-40) Move collar up to tighten belts.

5

VERSATILE ATTACHMENTS FOR YOUR TILLER...

1. THE HILLER/FURROWER

The Hiller/Furrower Attachment is one of the hardest working optional attachments you can consider for your PONY Model Tiller. It does so many jobs so well (from making rows... to digging ditches), and saves you hours of labor.

The Hiller/Furrower attachment consists of a V-shaped furrower blade, two hiller wings, a mounting bracket, clinch pin, and all the assembly hardware needed (it's shown fully mounted in Photo 5-41; and hard at work in Photo 5-42). It's quite easy to assemble and very convenient to attach to your tiller too. All you need is a 9/16-inch wrench (or adjustable wrench). With all that it does, it's no wonder so many Pony Owners have a Hiller/Furrower.

GETTING THE MOST USE FROM YOUR HILLER/FURROWER

The Furrower, by itself, has some particularly good uses in the garden. For example:

- Make rows to plant corn and other vegetable plants
- Dig a potato furrow
- Dig a trench for bio-degradable garbage disposal
- Dig a drainage ditch for wet areas

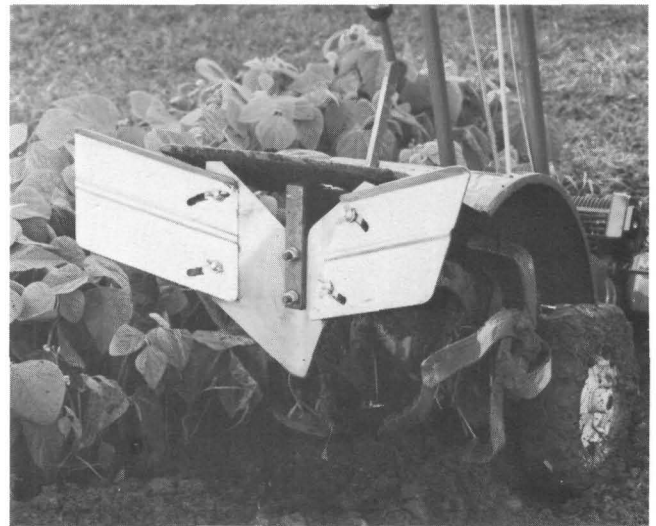

(Photo 5-41) Hiller/Furrower mounted.



(Photo 5-42) Furrower Blade with Hiller Wings lets you make rows, trenches, ditches.

BrentChambers.com

Add the hiller wings and you can:

- Hill growing crops to smother weed growth right within the rows
- Make raised rows so you can plant in wet areas if you have to



(Photo 5-43) Makes furrows as deep as 8"



(Photo 5-44) Furrow to plant potatoes. Use the Hiller wings to cover them up and later to hill the potato plants.

HOW TO USE THE HILLER/FURROWER

To get the most from the Furrower, first you should bust up the soil with the tiller, then till it with the Furrower in position. The tines throw the dirt at the blade, making the job of furrowing much easier. You should always leave the tines on when you use the Furrower.

- If you want to dig a deep furrow — (see Photo 5-43) — set the depth adjustment bar at the bottom notch (deepest setting) so the depth bar is out of the way where it will not interfere. PUT the forward drive belt in low speed groove and set the engine throttle for slow going.

- If you want a shallow furrow — set the depth adjustment bar in notch needed to reach the desired soil penetration. Put the forward drive belt in high speed groove and set the engine throttle for fast operation.

NOTE: Trying to make a furrow rapidly in a shallow pass makes it difficult to hold the tiller in a straight line. You will have to experiment with speeds for best results. If you want to furrow in a straight line on a slope, it is easier to do so by going downhill.

5

HELPFUL FURROWER TIPS — Before furrowing, be sure the soil was thoroughly tilled recently. Hard, chunky, or wet soil interferes with furrowing action. Leave the tines on the tiller when furrowing.

When furrowing, walk directly behind the tiller with both hands on the handlebars to maintain directional control.

- To make a straight furrow — Pick out a spot at the end of the row and aim your tiller at that spot as you till down the row.
- Furrow downhill on a slope — The furrower digs in too deeply going uphill.

HELPFUL HILLER TIPS

Hiller wings are adjustable so you can change the width of hilling. The maximum width (wings all the way down) is 21 inches, and the minimum width with the wings all the way up is 19½ inches.

- Low wing position is ideal for sturding up plants and for smothering weeds between small crops such as peas, beans and peppers.
- High wing position is just right for hilling potatoes and corn and for raised rows in wet or heavy soils.

2. THE PONY BUMPER

The Pony Bumper, our newest optional accessory, is worth its weight in gold because it does such a fine job of protecting expensive engine components and tiller parts from damage. The Bumper itself will take the punishment from accidental bumps, scrapes, dings against rocks and fenceposts . . . leaving the engine and tiller parts undamaged and new-looking.

Constructed of heavy-duty 1" tubular steel, the Pony Bumper not only offers protection for the carburetor, flywheel, blower housing and gas tank . . . it's also very handy for lifting the Pony into a car or truck, and for tying it down once it's loaded in.

Mounting the Bumper on your Pony Model Tiller is so easy too. There are very few parts and hardware to assemble, and a minimum of tools are needed. Complete, easy-to-follow instructions are included with each Bumper.

A lot of Pony Owners have ordered their Bumper because they know it's such an economical way to protect the valuable investment they have in their tiller. It's finished in classic TROY-BILT Red to match the color of the tiller.



(Photo 5-45) *The Bumper mounts fast and easy.*



(Photo 5-46) *The Bumper protects on all sides.*

3. THE ROW MARKER

The Row Marker Attachment is designed to hook up quickly and easily to the Troy-Bilt Furrower Attachment . . . and once attached, it makes laying out your garden with straight, neat, picture-perfect rows as simple as possible. Aside from a beautiful garden, the straight rows the Row Marker makes allow you to make maximum use of your available garden space.

And just think. You'll no longer have to go to the trouble and bother of working with stakes, strings, tape measures and other tools . . . the Row Marker replaces them all. And gives you a better result on top.

Fully extended, the Row Marker is 49-3/4" long. Fully retracted, it's 28" long. So you can vary the width between rows to suit the crop you're planting. Width adjustment takes only a few seconds and requires no tools. Putting the Row Marker together and mounting it on the Furrower Attachment (Remember: a Furrower is required for mounting) is easy too. Complete instructions are included. Another nice feature the Row Marker offers is its pivoting action . . . when you're finished marking off one row and you turn the tiller around to mark another row, just pivot the marker arm from left to right (or vice-versa).

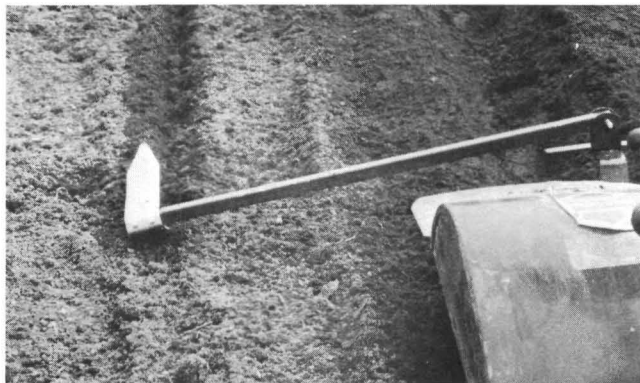

(Photo 5-47) *The Row Marker pivots to either side of the tiller.*



(Photo 5-48) *Straight, even rows are so easy.*

SECTION 6 – MAINTENANCE AND SERVICE OF TILLER AND ENGINE

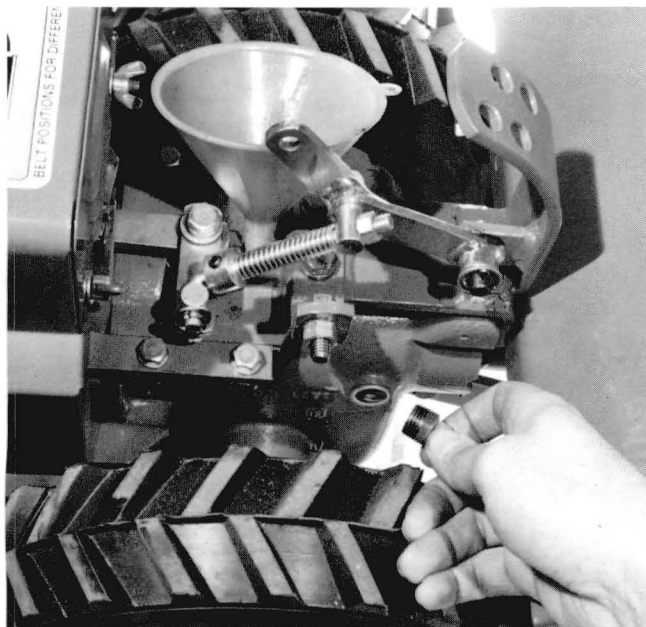

(Photo 6-1) Checking gear oil level

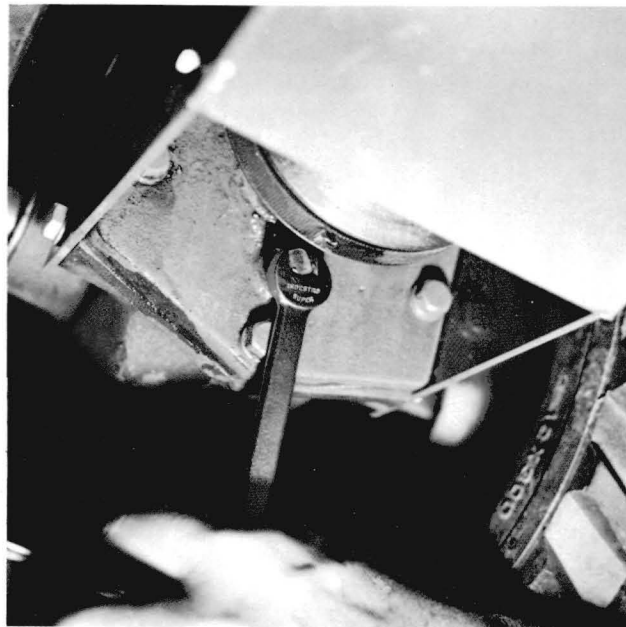

(Photo 6-2) Drain plug is beneath pulleys

6

In Sections 1, 2, 3, 4, and 5, you became familiar with how your Pony Model Troy-Bilt Tiller is assembled and what your Pony can do and how to do it, easily and safely. Now, it is time to take up that other point referred to in the Introduction: **How you can insure long lasting and proper performance from your tiller and engine** by always remembering to do the following:

1. Use motor oil for the engine that is classified either SE or SF and is #30 viscosity.
2. Use the proper gear oil for the tiller's transmission. Don't use multi-viscosity gear oil — use either SAE 140 or SAE 90.
3. Use a clean, fresh *regular* (leaded or low-lead) grade of gasoline in the engine. Do not use no-lead (unleaded) gasoline. See Engine Manufacturer fuel specifications.
4. Each day, check the engine oil level and cleanliness and the engine air cleaner. These checks should be made *even more frequently* if the tiller is used in dry, dusty conditions or for more than two hours without letup.
5. Clean, oil and adjust linkages of external parts of your tiller periodically. Keep nuts and bolts tight.

ADDING OR CHANGING TRANSMISSION GEAR OIL — The procedure for adding gear oil (if necessary) or checking gear oil level is described and illustrated in Section 1. However, checking and adding instructions are so important we repeat them here as well as describing how to change the gear oil in your transmission.

CAUTION: A rapid build-up of excessive heat will damage internal transmission parts such as gears, worms or bearings. Such a build-up can result from running the tiller with the transmission oil below the required level, let alone not having any gear oil in the transmission. Never put motor oil or automotive transmission fluid in the Pony transmission — they're too light. Always use SAE 140 or 90 viscosity.

- **Checking Gear Oil** — when the level is correct (see Photo 6-1) it flows out the hole when the oil level plug is removed — above the left wheel axle. Make this check when the tiller is cool because oil can expand if hot and give a false reading.
- **Changing Gear Oil** — transmission gear oil rarely needs changing. Do so only if its

become contaminated with dirt, sand or metal particles. To drain the transmission, (with a $\frac{3}{8}$ " wrench) remove the drain plug (see Photo 6-2) located in the transmission housing directly below the front transmission pulley. Remove the oil fill plug (see Photo 6-3) on top of the transmission near the handlebar base, to allow air to get in the top of the transmission. (The full transmission holds about $3\frac{1}{4}$ pints (52 to 54 oz.) A shallow pan with sufficient capacity is needed to catch the draining oil. When the old oil has drained out, clean the drain plug and you may apply a non-hardening gasket sealant to the threads. Reinsert the plug into the transmission case and tighten it.

- If you are just adding oil to bring the level up, put the depth regulator in the top notch (tines 1-2 inches off floor) and pour gear oil into the transmission until it starts to flow out the oil level hole on the left side.
- Transmission gear oil required is a straight SAE #90, or SAE #140 viscosity. Always use a good quality gear oil *and don't use a multi-viscosity gear oil* which could harm your tiller's bronze gears.

6



(Photo 6-3) If you add gear oil, keep tines off floor

ADDING OR CHANGING ENGINE CRANKCASE OIL — Please remember to check the engine oil level every day before you start to till. To add oil, make sure that the engine base is level and pour #30 SE or SF rated motor oil into the engine crankcase until it reaches the point of overflowing.

To Drain Oil From The Engine Crankcase:

1. Either of the plugs at the base of the engine can be used to drain oil from the crankcase.

One is shown in Photo 6-4 a little forward of the Oil Fill cap on the left side of the engine. The other (not shown) is opposite it on the right side. Drain oil when the engine is hot. Put a brick or wood block under the wheel opposite the drain hole you're using. Remove the plug. Catch the draining oil in a pan.

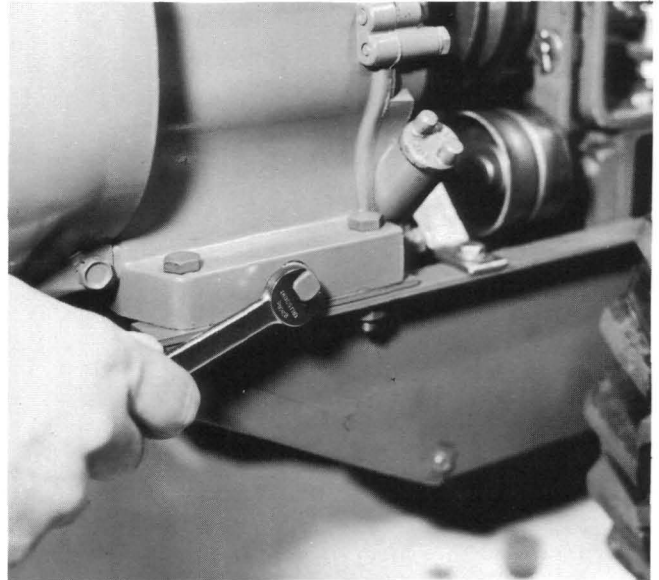

(Photo 6-4) Engine oil drain (one each side)

2. When the old oil has drained from the crankcase, make sure the engine is tilted toward the drain hole and patiently wait for the last bit—which will likely carry the most dirt and sludge out with it. Replace the drain plug.

3. Remove the Oil Fill cap and fill the crankcase with good quality SE or SF classified oil, #30 viscosity. Approximately $1\frac{1}{4}$ pints will be needed to bring the level of an empty crankcase up to the point of overflowing.

CAUTION: When either adding oil to the crankcase or refilling it for an oil change, make sure that the oil level is full to the point of overflowing from the top of the Oil Fill tube. If the oil is not quite up to the top of the filler neck, you'd best fill it up. Make sure the level is right up to the top, ready to flow over the fill tube. Some folks have looked in the tube, have seen oil down in the tube and assumed it was O.K. because they could "see" the oil. Then, they ran their engines when it was low on oil—damaging them.

4. The engine manufacturer recommends changing oil after the first five hours of operation (two fuel tanks full). Thereafter, we recommend you change the oil every 10 hours of use. However, if you till or cultivate under hot, dry, and dusty conditions, or if you oper-

ate the tiller for two hours or more without letup, the oil level should be checked more often, and the oil changes are required more frequently.

AIR CLEANER—Every time the tiller is used, before starting the engine, check the air cleaner. In addition, we recommend that it be checked every few hours when it is operating in hot, dry or dusty conditions.

CAUTION: A properly serviced air cleaner protects internal parts of the engine from dirt and dust particles in the air. If air cleaner maintenance instructions are not followed, the dirt and dust will be drawn into the engine and form an abrasive mixture which quickly wears the moving parts. This could ruin your engine. To avoid engine damage, clean the air cleaner and re-oil the element.

CLEAN AIR CLEANER AND RE-OIL ELEMENT—The condition of the air cleaner should be checked at the start of each tiller use, or every few hours under extremely dusty conditions.

Follow these steps:

1. Remove screw fastening the air cleaner to the carburetor (use a screwdriver if you need it)—see Photo 6-5. Remove the air cleaner carefully to prevent dirt from entering the carburetor.
2. Take the air cleaner apart. See Photo 6-6.
3. Wash the foam element in kerosene or in liquid detergent and water to remove dirt. Wrap the foam in a cloth and squeeze dry.
4. Saturate foam in engine oil. Squeeze to remove excess oil. Clean the base thoroughly and re-assemble parts of air cleaner.
5. Replace air cleaner on top of carburetor and fasten it with the screw.

CLEAN COOLING SYSTEM—Grass or chaff may clog the cooling system (the fins on the engine block)—see Photo 6-7. When the engine is cool, use a screwdriver to help you clean out grass, leaves and crop residues between the fins and under the blower housing. Don't remove the blower housing unless it's really necessary. Continued operation with a clogged cooling system causes severe overheating and leads to engine damage. Clean the cooling system regularly.

SPARK PLUG—The spark plug should be cleaned and the gap reset at 0.030" at least at the start and end of each tilling season (or every 40 hours of operation).



(Photo 6-5) Air cleaner removal

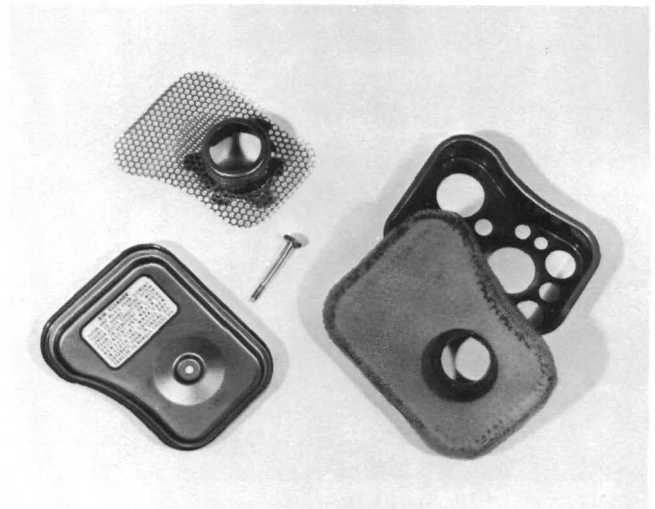

(Photo 6-6) Air cleaner elements



(Photo 6-7) Remove debris under blower housing.

LUBRICATE TILLER WITH OIL—The following points should be lubricated with oil at regular intervals:

- The universal assembly operated by the Wheel Drive Lever (the fork-like arrangement to which you attached the bottom of the wheel drive lever—see Photo 6-8).
 - Turn the Wheel Drive Lever to DRIVE and put a few drops of oil at the outside end of the clutch yoke to prevent rust formation—see Photo 6-9. The end of the yoke is seen as the bright metal part that moves in and out when you turn the wheel drive lever.
- The entire length of the throttle cable and casing (see Photo 6-10) from the remote Engine Throttle control on the control panel to the throttle located on the engine — see Photo 6-11.
 - All pivot points on the Forward/Reverse lever linkage — see Photos 6-12, 6-13, 6-14, 6-15.
 - Spring and plunger for the depth regulator — see Photo 6-16. Also the drag bar.
 - Oil other bolts (except on the engine) occasionally.

6



(Photo 6-8) Oil universal

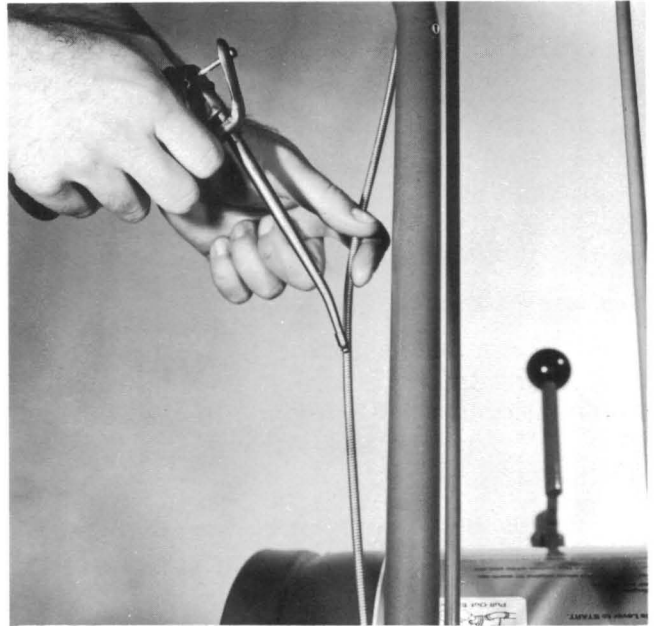

(Photo 6-10) Oil throttle cable all along length. Oil will work through spring just fine.

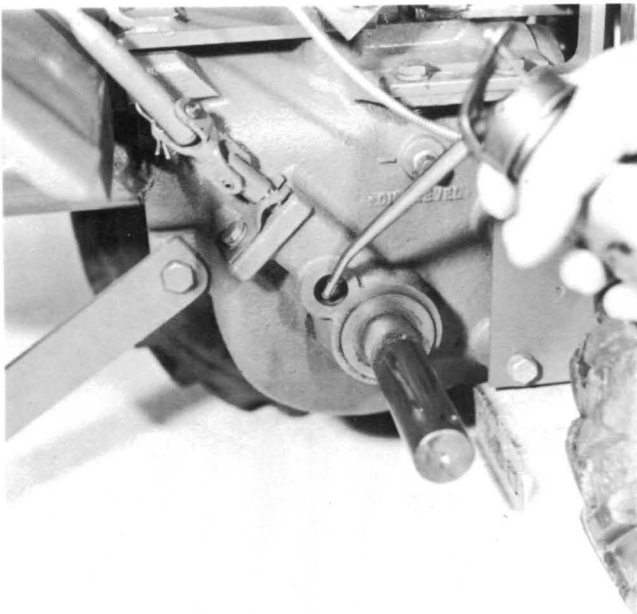

(Photo 6-9) Oil end of yoke. Wheel is removed to show location.

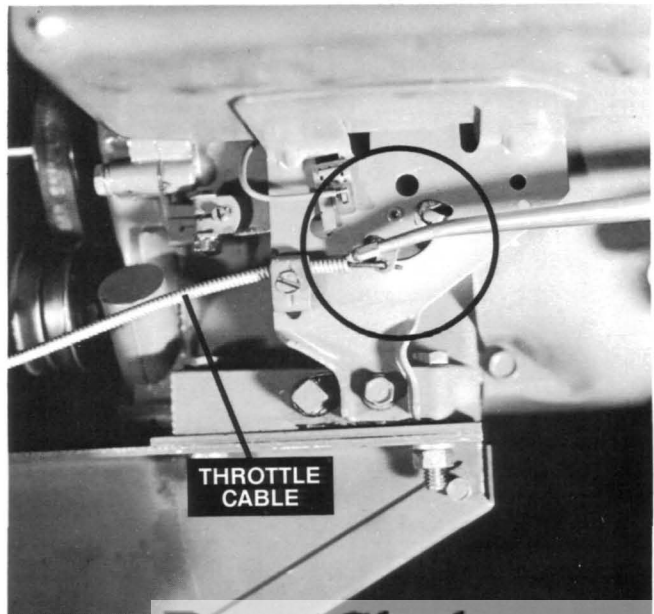

(Photo 6-11) Oil throttle cable

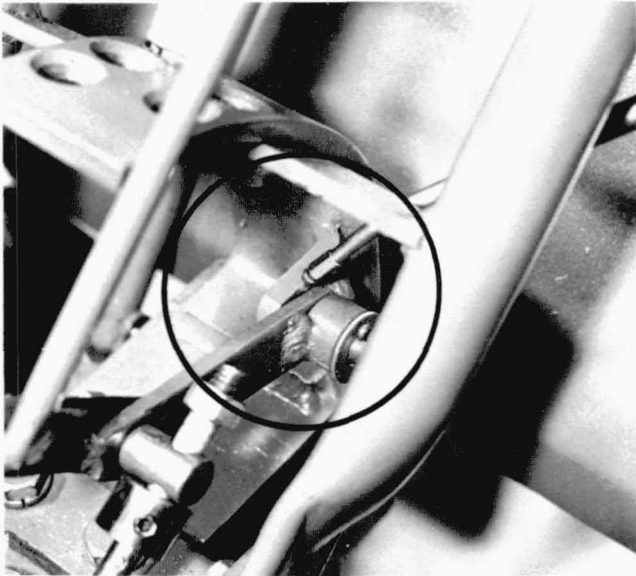

(Photo 6-12) Forward/Reverse clutch

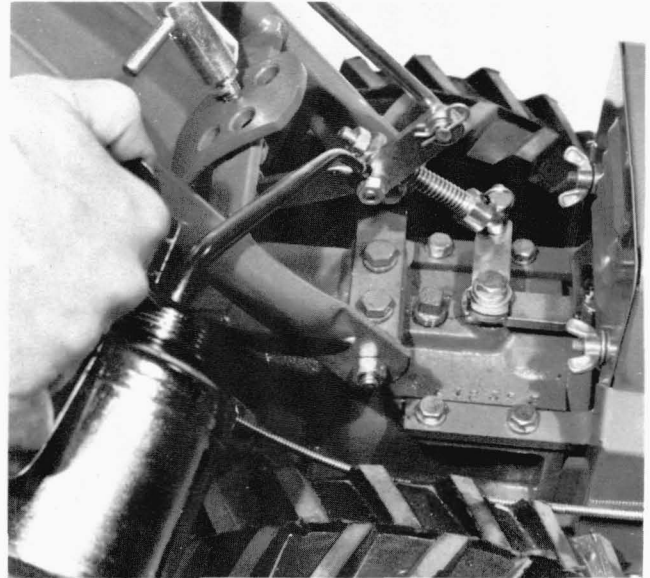

(Photo 6-15) Swivel & Nut

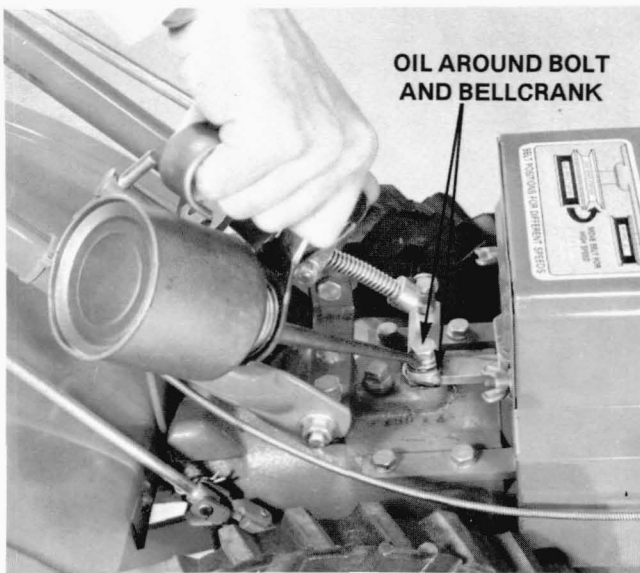

(Photo 6-13) Forward/Reverse bellcrank

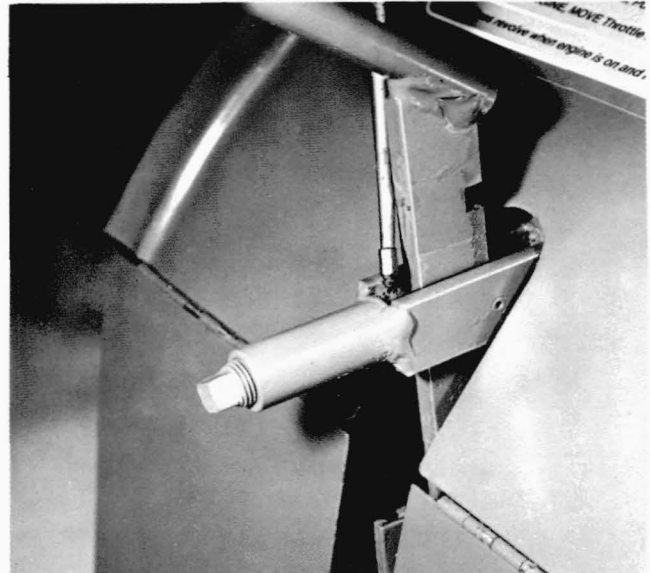

(Photo 6-16) Oil spring and plunger

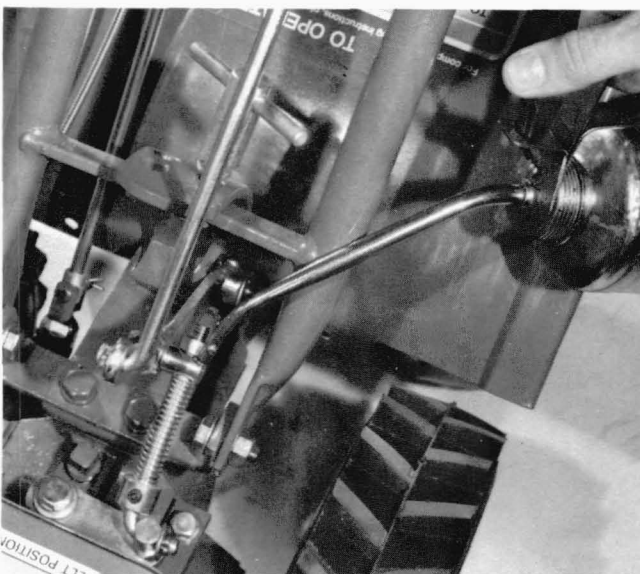

(Photo 6-14) Adjustment Linkage

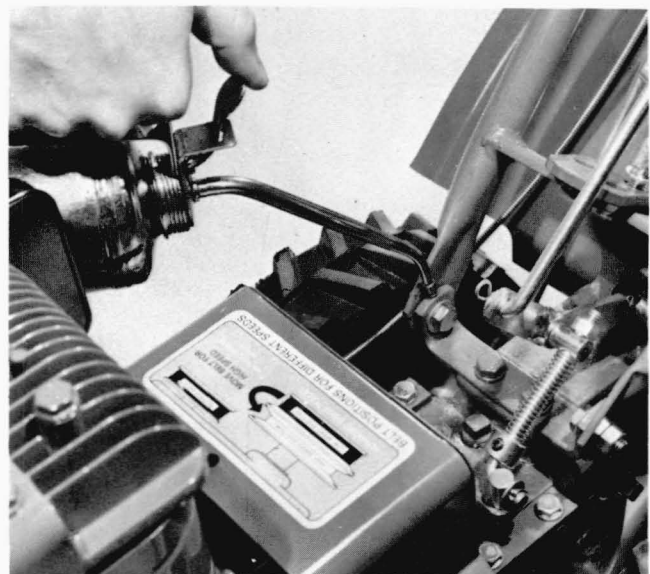

(Photo 6-17) Oil bolts occasionally

LUBRICATE WITH GREASE—To the following areas apply a quality grease containing a metal lubricant (adds durability and is recommended). Regular grease may be used if necessary.

- Wheel shaft — see Photo 6-18. Remove one wheel at a time, using a hammer and drift pin to tap out the spirol pin that secures the wheel to the wheel shaft. Apply grease to shaft.
- Forward/Reverse slide linkage — see Photo 6-19.
- Connecting Rod and Adjustment Swivel. Put Forward/Reverse Lever in Forward to do this. See Photo 6-19.

NOTE: Idler pulley shafts (forward and reverse — see Photo 6-20 — have bearings sealed in grease. Do not oil or grease.)

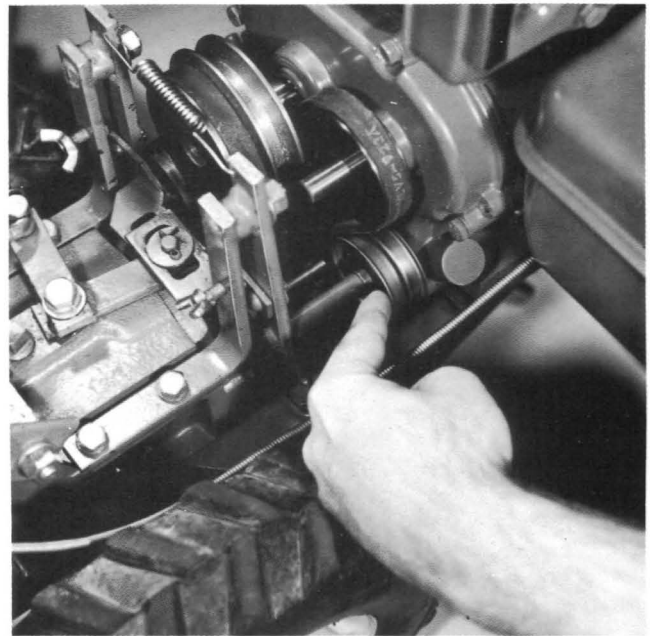

(Photo 6-20) Sealed bearings—don't grease

6

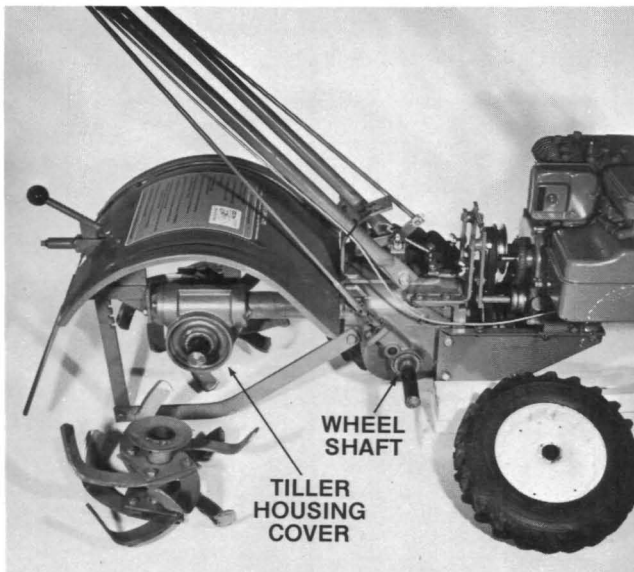

(Photo 6-18) Wheels and tines removed

LUBRICATE WITH OIL OR GREASE—The following parts may be lubricated with either oil or grease:

- Depth adjustment bar of the depth regulator—see Photo 6-21.
- Handlebar height adjustment T-bar screw threads—see Photo 6-22.

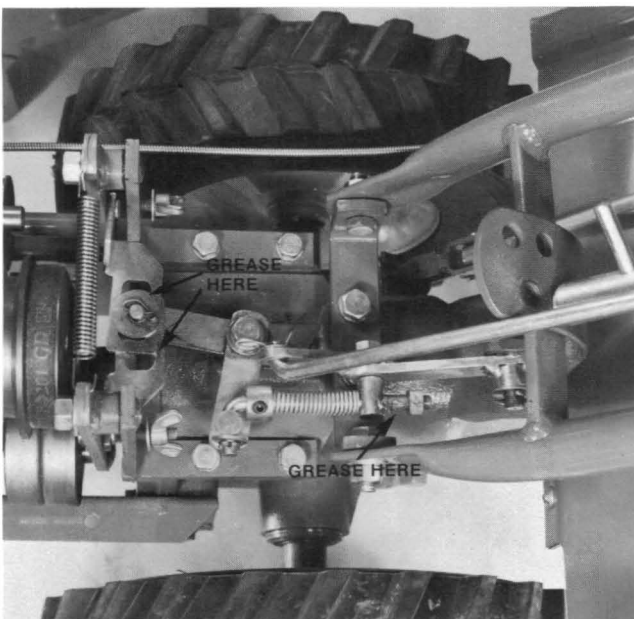

(Photo 6-19) Grease sliding linkage

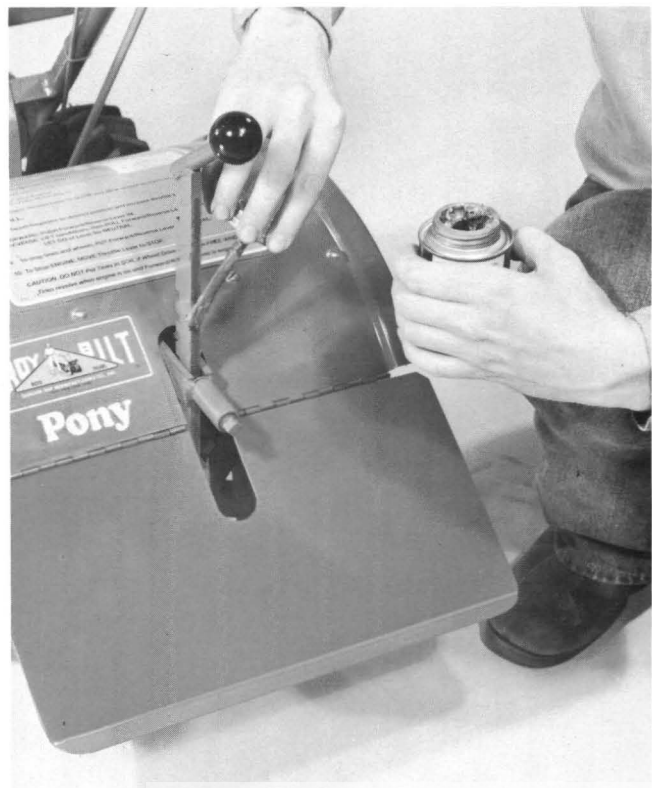

(Photo 6-21) Grease back and sides of depth adjustment bar

BrentChalmers.com

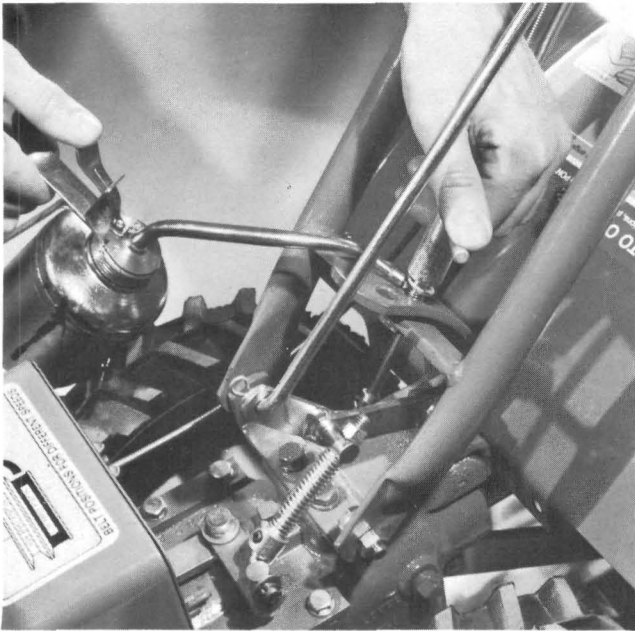

(Photo 6-22) Oil T-bar threads

TIGHTEN BOLTS AND NUTS—Periodically check all nuts and bolts and tighten any which may have become loose. Three areas where loose screws or bolts can be responsible for oil leaks are:

- **Front Cover for Transmission**—This cover is not readily visible until the tines are lowered and the tiller is tipped back (see Photo 6-23). To tighten the five $\frac{5}{16}$ "-18 hex head cover bolts, you need a $\frac{1}{2}$ " wrench; for the $\frac{1}{4}$ " pipe thread drain plug, you need a $\frac{3}{8}$ " wrench.

Between the front cover and the transmission, a thin gasket provides the oil seal. (For its shape, see Sketch 6-24.) NOTE: Whenever any screws or bolts are removed, be sure to coat them with non-hardening gasket sealant before replacing and tightening them.

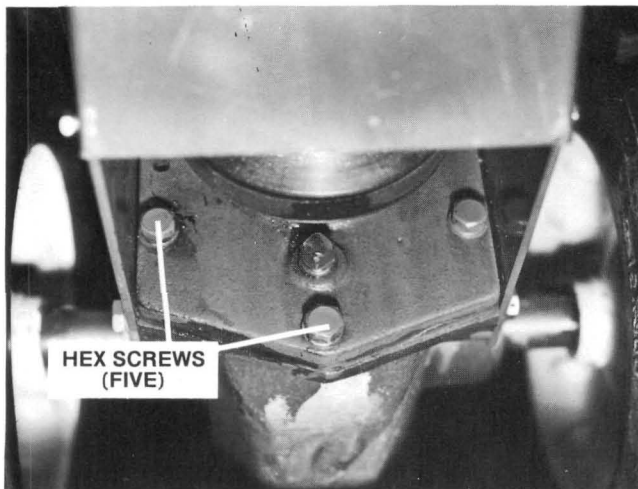

(Photo 6-23) Transmission cover

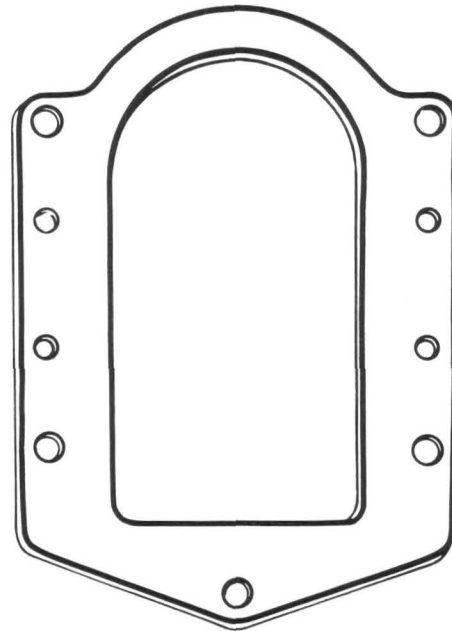

(Sketch 6-24) Cover gasket

- **Tiller Housing Cover** — To tighten the five self-locking hex-head bolts, or if you have an older model the five socket head screws, which fasten the cover to the tiller housing on the right side, you need a $\frac{7}{16}$ " wrench (for bolts) or a $\frac{3}{16}$ " hex wrench for screws. If these bolts or screws are loose, an oil leak can occur. (See Photo 6-18.) You must first remove the bolt holding the tine assembly to the shaft and tap the tine assembly loose from the shaft to gain access to the housing cover.
- **End Cap** — Three hex-head, self-locking screws hold the end cap to the tiller housing and if loose, could cause an oil leak. These screws are not immediately accessible: they're under the hood bracket. To reach them and tighten them, follow these steps:
 1. Use a $\frac{9}{16}$ " wrench and remove the two middle bolts shown in Photo 6-25.



(Photo 6-25) Front hood bolts

2. Remove both mounting bolts that clamp the hood bracket depth regulator to the end cap — see Photo 6-26. Use a 1/2" wrench.

3. Removing the hood bracket bolts will give you the clearance you need to tighten the hex head screws in the end cap. (See Photo 6-27).

4. Replace the depth regulator assembly and tighten the bolts fastening it to the end cap.

5. Replace the front hood bolts (Photo 6-25).

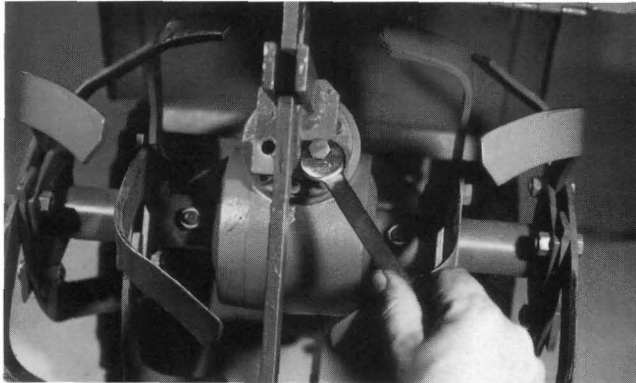

(Photo 6-26) Hood bracket bolts.

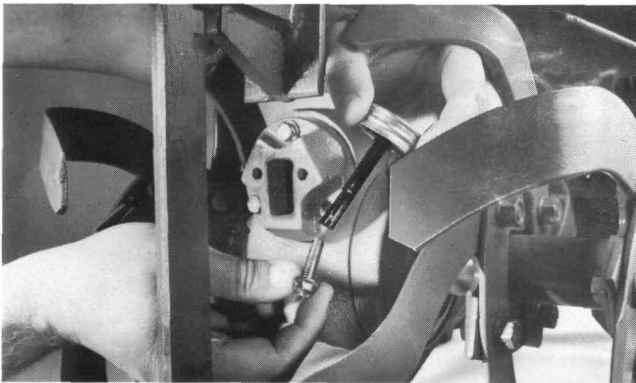

(Photo 6-27) End cap, self-locking screws.

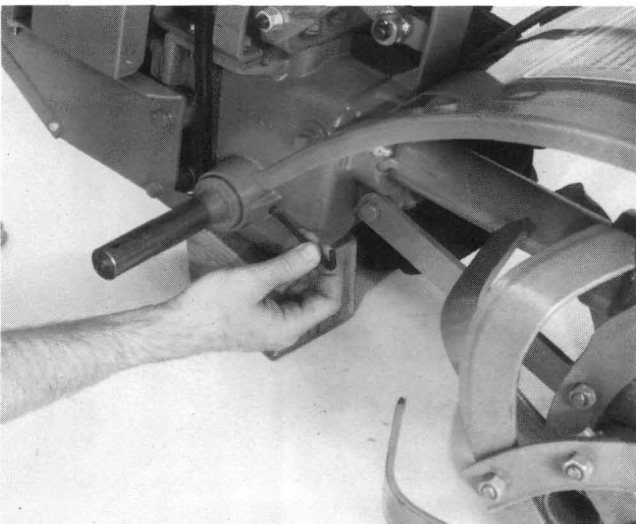

(Photo 6-27A) Set screws in wheel hubs.

CHECK FOR OIL LEAKS — Your tiller was carefully assembled and checked at the factory, so you shouldn't have much of a problem with oil leaks. They could happen, however, and sooner or later they will happen because oil seals wear. It may be years before yours do.

CAUTION: Do not use Motor Oil in your tiller transmission. It is too light, and it will seep by the seals. Make sure that you always use SAE #90 or SAE #140 GEAR OIL in your tiller.

As a routine maintenance procedure, or if you suspect an oil leak, you should check oil seals, cover gaskets, check for unsealed threads of bolts or screws which go into the transmission gear oil areas (make sure they are tight), loose covers, or the pipe plugs in your transmission.

Please Note: Your transmission gear oil is not under pressure, but two rear bolts for the mounting brackets of the drive pulley linkage go through the top of the transmission and act as relief points. If hot days and hard tilling cause the oil to heat up and build up some pressure, some oil might seep out across the top and down the side. This is nothing to worry about as long as the transmission is not overfilled. You can readily check the transmission oil height at the oil level plug on the right side.

WHERE TO CHECK — In addition to the above, there are four specific areas which you should check. They include the end cap (Photo 6-27), the lower front transmission cover (Photo 6-23), the tiller housing cover — right side (Photo 6-18), and the socket head screws in the wheel shaft hubs (one per side) (Photo 6-27A).

NOTE: Before starting your check, clean off and dry any area on which you find oil or dark dirt that is wet with oil. Then, watch for oil seepage to locate the leak, if there is one.

1. End Cap — At the end cap, the possible problems are: (1) a loose end cap; (2) screws without sealant; or (3) a leaky gasket. Tighten and seal screws and replace a leaky gasket.

2. Front Cover for Transmission — The possible problems with the front cover include: unsealed bolts, a leaky gasket, oil seal behind the drive pulley, or lack of sealant on the transmission gear oil drain plug.

3. Tiller Housing & Housing Cover — Possible problems with the tiller housing are similar: unsealed bolts or screws (screws on older models); leaky gasket; tiller shaft oil seal (both sides); possible poor fit of cover in tiller housing. Wipe area clean and dry, look for leak. Determine if leak goes through seal or from around cover (loose cover or bad gasket), or from holes for bolts (no sealant).

4. Set Screws In Wheel Shaft Hubs — Leaks from around either loose or unsealed set screws. Remove, apply sealant, replace but do not overtighten screws or wheel shaft will bind. Rotate wheel shaft by hand while tightening screws, stop tightening when slight drag on the wheel shaft is felt. Use a $\frac{3}{16}$ " hex key wrench to tighten.

REMOVING AND REPLACING BOTH BOLO TINE ASSEMBLIES

The Bolo Tine Assemblies (tines and tine holder) on each side can be removed with two $\frac{9}{16}$ " wrenches and a rubber mallet. First disconnect spark plug wire and tuck its boot between two cooling fins (see Photo 4-8, pg. 27). Then, gently tilt tiller forward on its engine. Place weight on the engine to keep the tiller end up.

To Remove The Tine Holder

1. Using two $\frac{9}{16}$ " wrenches, remove the bolt, lockwasher and locknut that secure the tine holder to the tiller shaft (see Photo 6-28).
2. Using the rubber mallet, you may have to tap tine assembly outward (Photo 6-29) to loosen the holder. Pull tine assembly off.
3. To replace the tine assembly, align the holes in the holder and shaft and replace the bolt, lockwasher and locknut. Tighten securely.

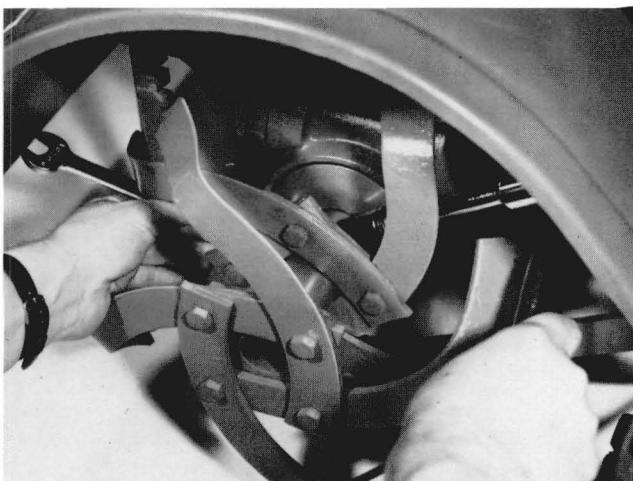

(Photo 6-28) Remove the tine mounting bolt.

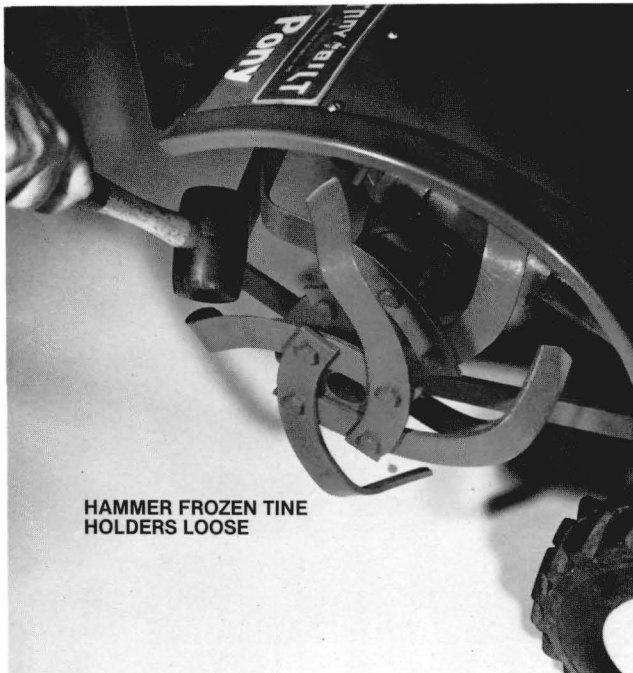

(Photo 6-29) Tap tines and holder loose.

6

To Remove And Replace A Single Tine

Use two $\frac{9}{16}$ " wrenches to remove the two bolts, lockwashers and nuts (bolts and locknuts on older models) securing the tine to the holder (Photo 6-30). When replacing the tine, the heads of the bolts should face outward. Replace the bolts, lockwashers and nuts. Tighten this hardware securely.

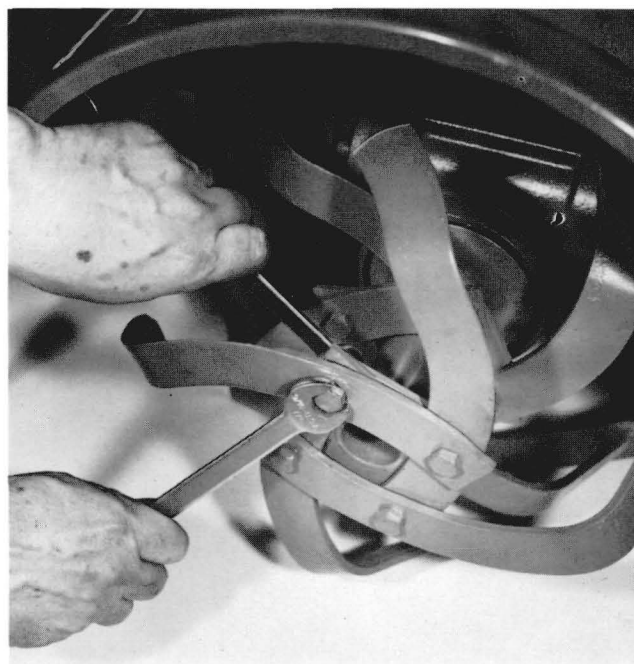

(Photo 6-30) Removing a single tine.

HOW TO REPLACE THE FORWARD AND REVERSE BELTS

Factory-fresh belts can give your tiller a new lease on life in the garden. Replacing belts once they start slipping or are worn out (are nicked, stretched or cracked) is really quite simple, and these step-by-step instructions will explain how.

The Reverse Belt is Part No. 9200, the Forward Belt Part No. 9201, and a set of both is Part No. 20402. The two look the same, but they **are** different, so the part numbers are marked right on the belts.

SAFETY CAUTIONS:

- Disconnect the spark plug wire and tuck the rubber cap on the wire in between two engine cooling fins before you begin any work on the belts. You'll be pulling the engine starter cord to help removal and replacement and you must make **absolutely sure** that the engine can't possibly start.
- If you've been using your Pony, wait for the muffler to cool down before starting any work.

BEFORE YOU START, FAMILIARIZE YOURSELF WITH THE PULLEYS

6 Familiarizing yourself with the pulleys and the grooves on each pulley will make belt changing so much easier. Begin by lifting the belt cover off after you loosen the two wing nuts shown in Photo 6-31. In Illustration 6-31A and Photo 6-31B all the pulleys and their grooves are identified. Note you'll need to get the reverse belt off the lower pulley even if you want to replace **only** the forward belt. Also, the belts are not elastic, so you won't be able to just pull them off. That's why you'll slowly pull the engine starter cord to help you "ride" the belts off the engine pulleys. Also, sitting along the **right** side of the tiller (engine at your right; handlebars at your left) is a good, no-strain working position for changing belts.

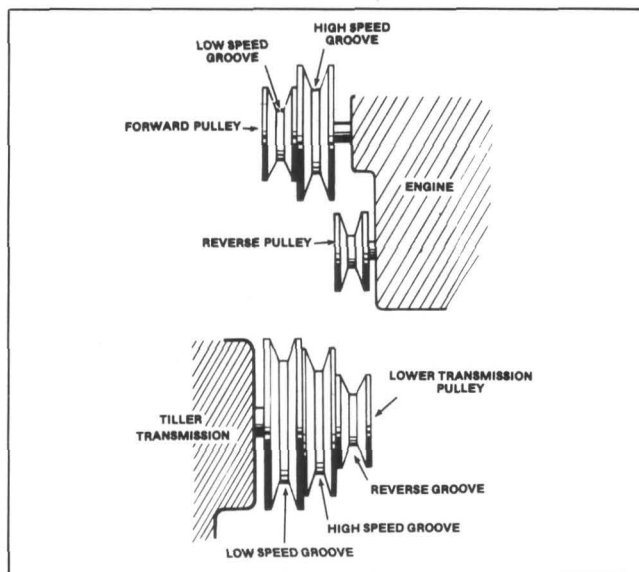

(Sketch 6-31A) Imaginary side view of pulleys with belts removed.

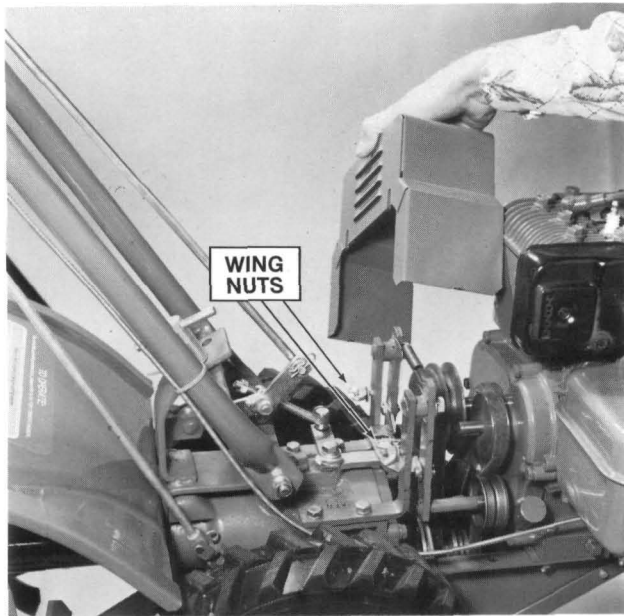

(Photo 6-31) Loosen wing nuts; lift off cover.

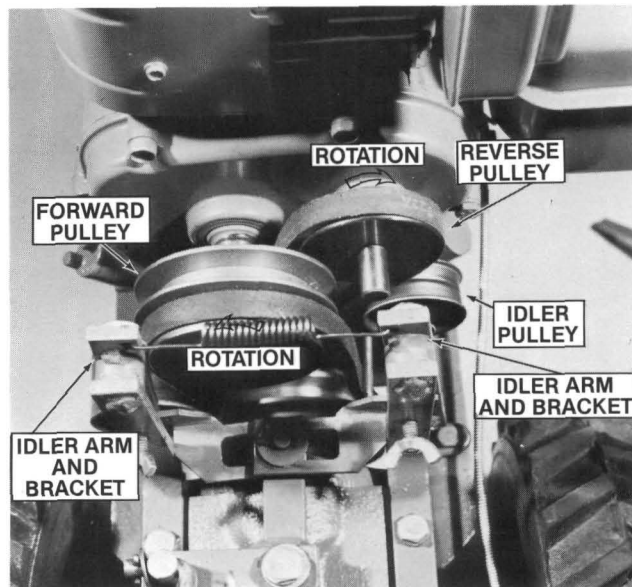

(Photo 6-31B) Pulleys from top, belt cover has been removed.

1. REMOVING THE REVERSE BELT

STEP A Put the forward/reverse lever in Neutral. Next remove the reverse belt guide (shown in Sketch 6-32) by taking off the bolt-lock-washer/plain washer combination with a 7/16" wrench. (Note that the reverse belt guide is located on the other side of the tiller from which you'll be completing all the other steps in belt replacement.) Once the belt guide is removed, you'll have more room to twist and slide the reverse belt between the forward and reverse engine pulleys. Don't forget to replace the belt guide after you're finished replacing either or both of the belts.

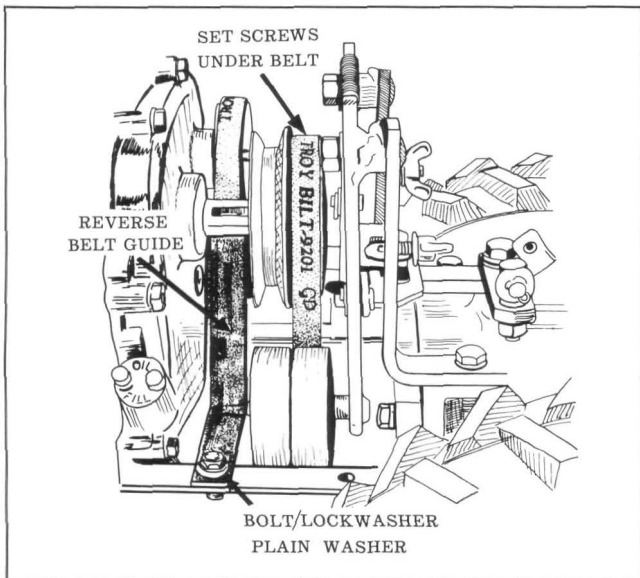

(Sketch 6-32) Remove reverse belt guide to make more room to twist reverse belt between pulleys.

Now, using one hand to grip the engine starter cord (Photo 6-32A), take one or two fingers and place them down along the other side of the reverse belt between the belt and engine (toward the handlebars) so that the belt rides out of the groove (Photo 6-32B).

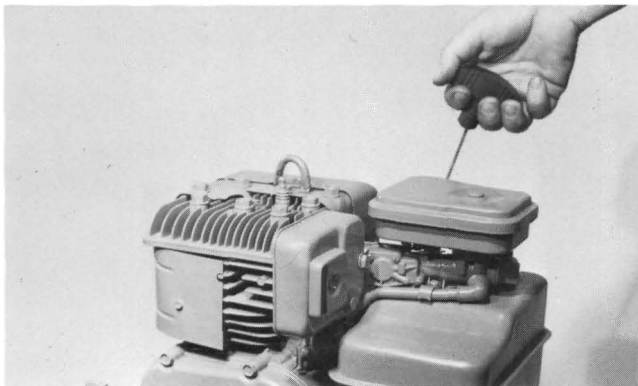

(Photo 6-32A) Slowly pull starter rope to help ride belts in and out of grooves.

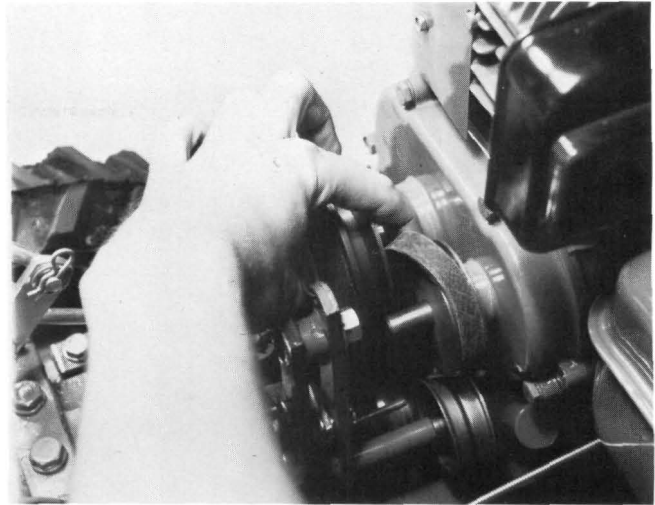

(Photo 6-32B) Continuously pull on reverse belt while pulling start rope. Some force needed.

STEP B When the belt is out of the reverse pulley's groove, push the belt downward a little to give yourself some slack around the lower (transmission) pulley. Reach underneath the lower pulley and pull the reverse belt out of the transmission pulley groove, forward (toward the engine), upward, and then off the lower pulley (Sketch 6-32C).

NOTE: If you are simply getting the reverse belt out of the way so you can remove the forward belt, you don't need to completely remove the reverse belt from the tiller. Just getting it off both the upper and lower pulleys, as you have just done, is enough. Stop here, and go on to the instructions on "Removing the Forward Belt." However, if you want to completely remove the reverse belt, go to STEP C in this section (next step).

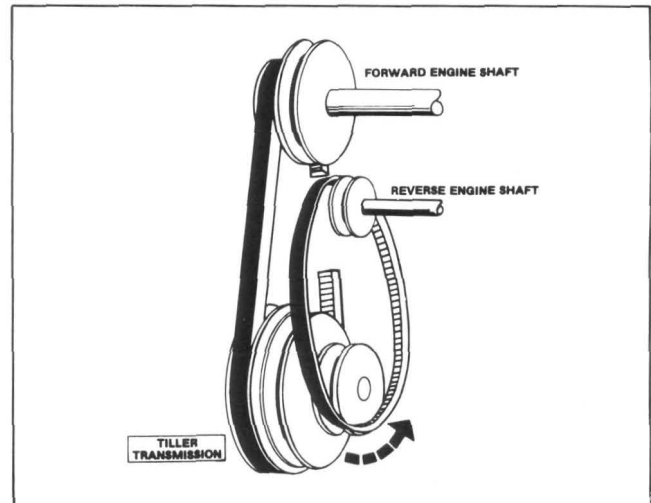

(Sketch 6-32C) Slip reverse belt off lower pulley.

STEP C Now that the reverse belt is off the lower pulley, pull up on the reverse belt. With both hands twist the belt so it will flatten and fit between the reverse and forward pulleys up top (as in Photo 6-32D). Once it's twisted to fit between the top pulleys, push the belt downward, through the space, working it out from between the pulleys. You should now be able to completely remove the reverse belt as in Sketch 6-32E.

However, if you are unable to pass the reverse belt between the reverse and forward pulleys up top, it may become necessary for you to loosen the forward pulley and slide it away from the engine, thereby increasing the clearance between the forward and reverse pulleys so the reverse belt can slide more easily between these pulleys. Loosening the forward pulley so it will slide away from the engine is quite easy. The forward pulley is held on to its shaft by two set screws located in the low speed groove of the pulley.

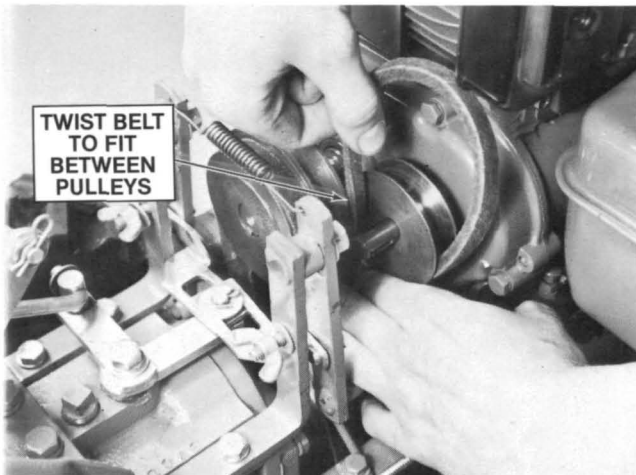

(Photo 6-32D) Careful force needed to do this.

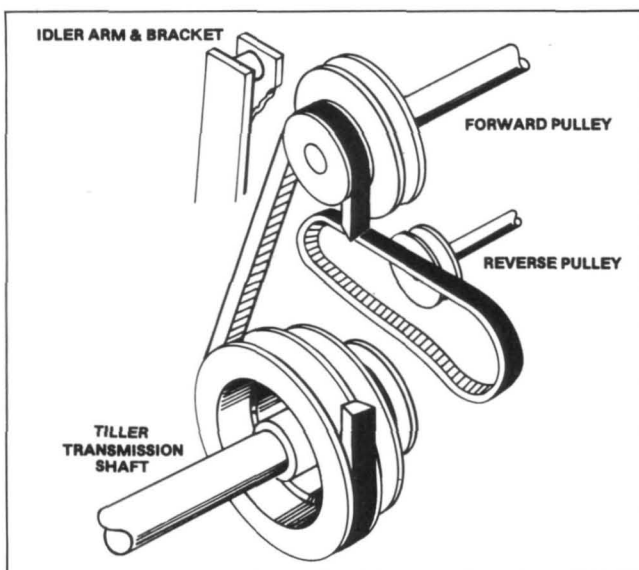

(Sketch 6-32E) Remove reverse belt out side.

Note: If the forward belt is in the high speed groove, the set screws in the low speed groove will be easily seen. Just use a 5/32" hex key wrench to loosen both screws, then slide the pulley away from the engine. The reverse belt should slide out easily now. If the forward belt is in the low speed groove however, you must move the belt out of the groove to gain access to the screws. To do this, see STEP A in Section 2 under belt changing instructions. Once the belt is out of the low speed groove, loosen the screws and slide the pulley away from the engine in order to remove the reverse belt. See Section 4 in belt changing for instructions on how to "Replace the Reverse Belt". Once the new reverse belt is installed, be sure to slide the forward pulley back into position (it should line up with the grooves in the lower pulley), and tighten the set screws fully. If you had to remove the forward belt from the low speed groove, be sure to reposition it in this groove again.

2. REMOVING THE FORWARD BELT

STEP A Now that the reverse belt is out of the way, as described in Steps A and B of "Removing the Reverse Belt", you can remove the forward belt. The forward-reverse lever should be in Neutral. With one hand gripping the starter cord, use your fingers to pull the right hand side of the belt back toward the handlebars of the tiller while slowly pulling on the starter cord to turn the pulley. See Photo 6-32F. This will help the belt ride out of the groove, over the ridge of the groove and off the face of the pulley near the idler bracket.

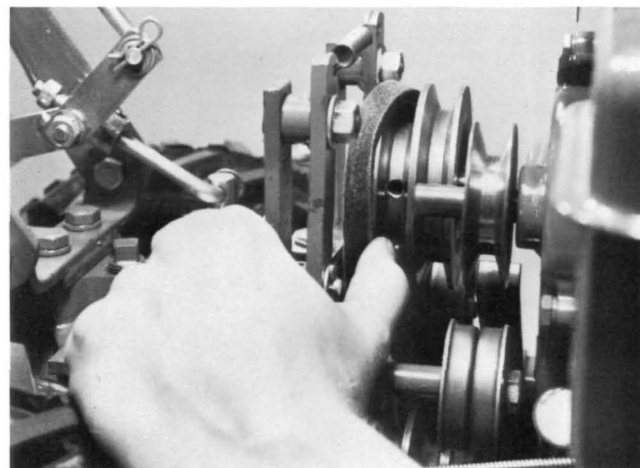

(Photo 6-32F) Pull back on forward belt while slowly pulling starter rope.

STEP B With both hands, flatten the belt so it will fit between the pulley and the idler bracket (Sketch 6-32G). Then, push the belt downward to give yourself some slack down around the lower pulley and pull the belt off the lower pulley towards the engine and up, away from the pulley as in Sketch 6-32H.

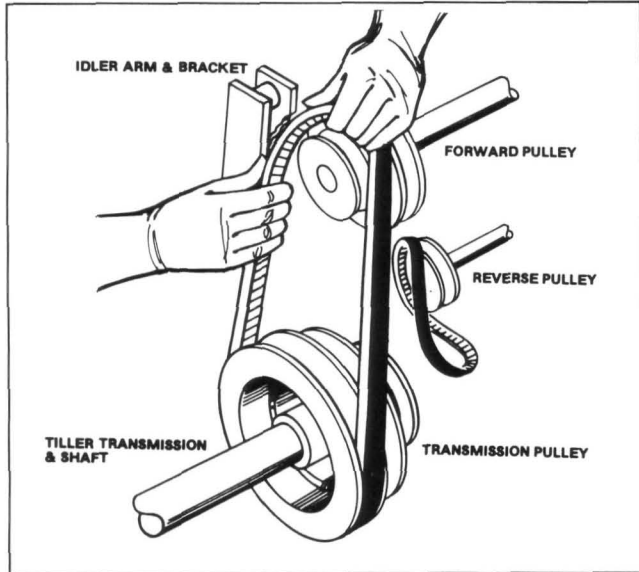

(Sketch 6-32G) Wedge belt down between pulley and idler arm/bracket.

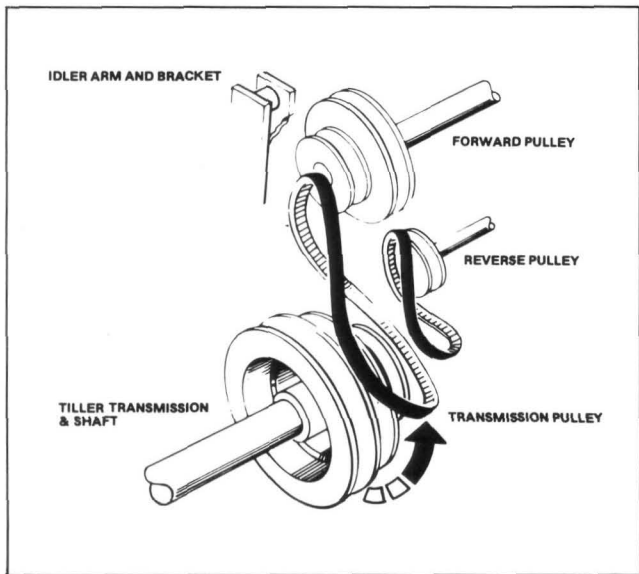

(Sketch 6-32H) Slip belt off lower pulley.

STEP C With the belt now free of the pulleys, you can pull it out from between the two idler brackets and away from the tiller (Photo 6-32I).

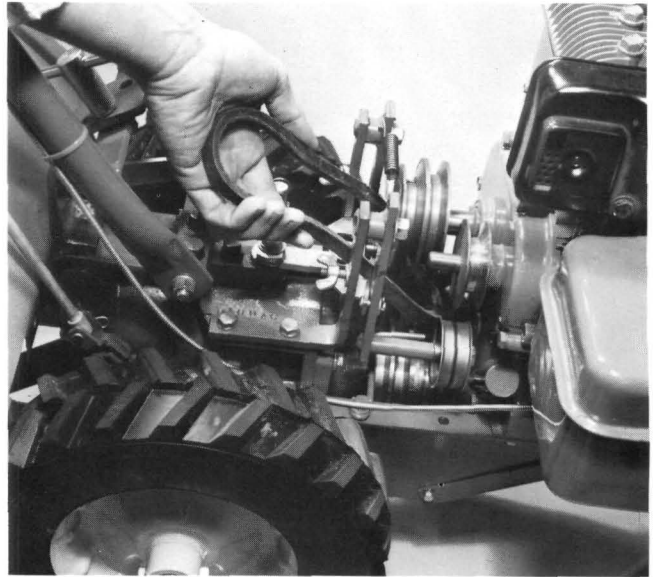

(Photo 6-32I) Remove forward belt this way or out from the bottom.

3. REPLACING THE FORWARD BELT

6

CAUTION: Make sure the spark plug wire is disconnected so the engine can't possibly start.

STEP A Put the Forward/Reverse Lever in Neutral. Shape the forward (larger) drive belt into a flattened loop and stick it between the idler brackets toward the engine. Push the loop down until it is down around the front end of the lower pulley, or at least in the general area. See Sketch 6-32J.

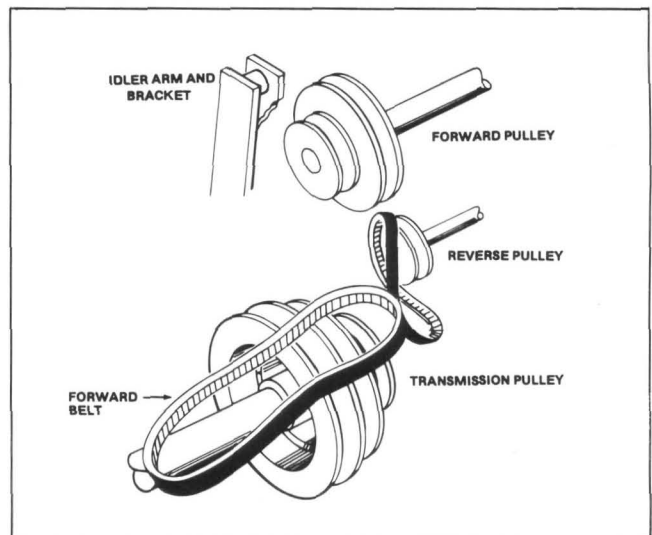

(Sketch 6-32J) Start putting forward belt in this way.

STEP B Reach underneath the lower pulley and place the loop in the speed groove you choose (either low or high speed). Sketch 6-32K shows the belt in the low speed groove on the transmission pulley.

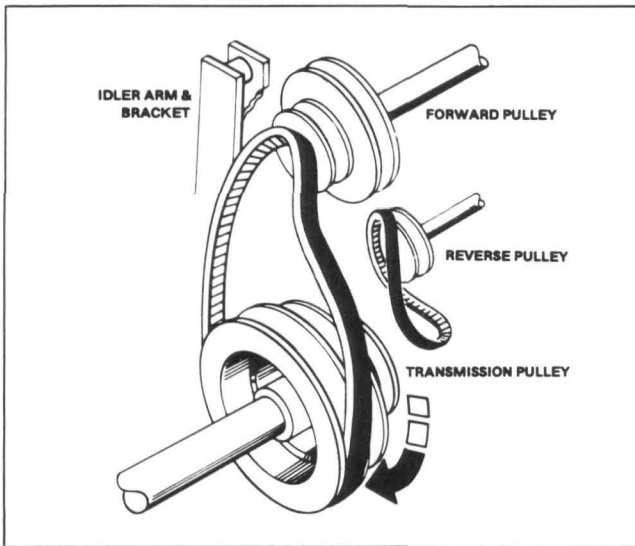

(Sketch 6-32K) Slip forward belt onto lower pulley (shown here in low speed groove).

STEP C Now go back up to the forward pulley. Take the right side of the forward drive belt and put it in the corresponding speed groove in the right side of the pulley (shown in the low speed groove in Sketch 6-32L). While holding the belt in the groove (Photo 6-32M), grip the starter cord and pull slowly. This will turn the pulley and the belt will ride into the groove. Watch out for your fingers! Now give one extra pull, slowly, to make sure that the belt is seated on the lower pulley as well.

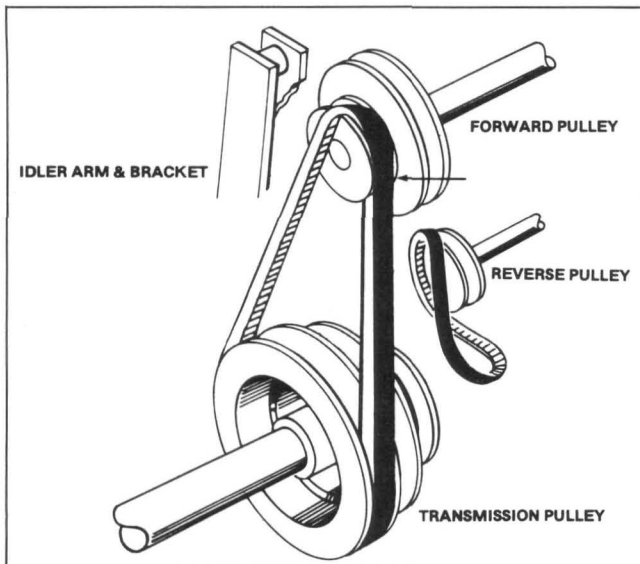

(Sketch 6-32L) Put top section of belt in this side of pulley (shown here in low speed groove).

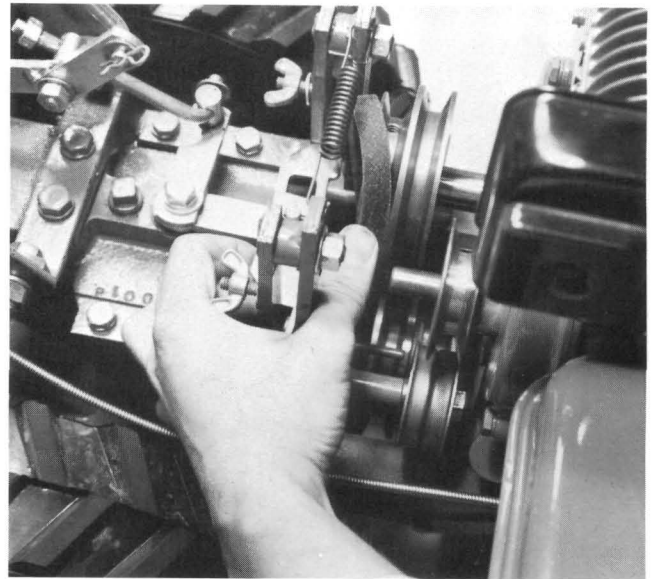

(Photo 6-32M) Hold belt here, slowly pull starter rope.

4. REPLACING THE REVERSE BELT

If you have completely removed the reverse belt as in Steps A through C in "Removing the Reverse Belt," start with Step A here. If you've only gotten it out of the way in order to remove and replace the forward belt, you can start with Step B. **IMPORTANT:** The Forward/Reverse Lever should be in Neutral.

STEP A The first thing you want to do is get the reverse belt through the space between the reverse pulley and the forward pulley. Use both hands, one under the reverse pulley and one over it, and twist the belt to flatten it. Then push the flattened belt through the space, as shown in Photo 6-33.

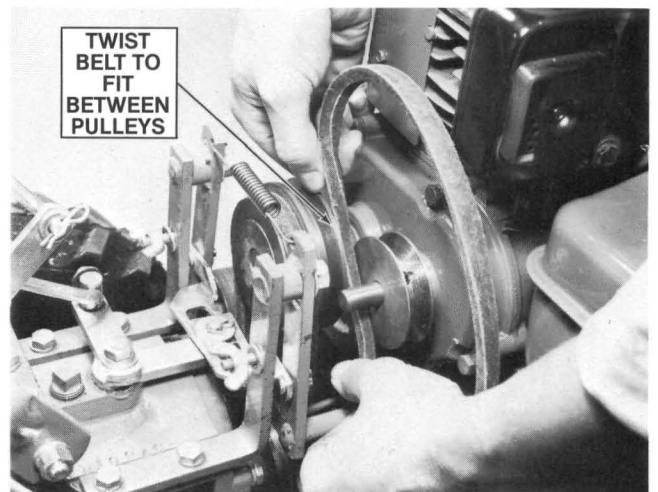

(Photo 6-33) Twist and work through with some careful force.

STEP B Push the belt down so the bottom loop is around or near the front (reverse) groove of the lower pulley, which is the groove closest to the engine. Reach underneath the tiller and slip the belt over the lower pulley, seating around the reverse groove by “feel” (Photo 6-33A).

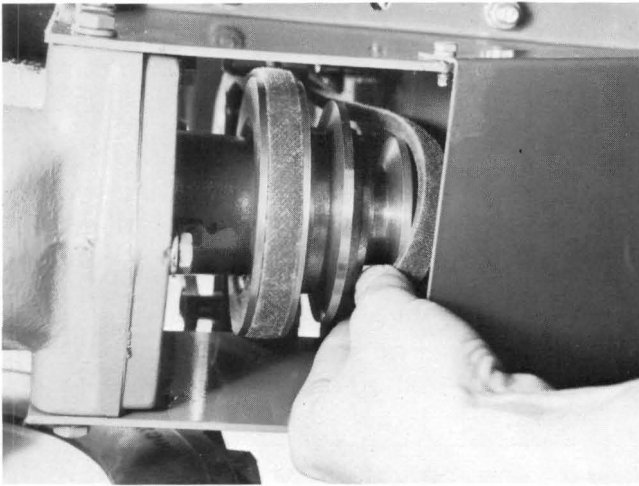

(Photo 6-33A) Underside of tiller shown. Reverse belt goes into reverse groove on lower pulley.

STEP C Now, ride the belt into the reverse pulley up top. Seat the far side of the belt in the far side of the reverse pulley. Hold it there with your finger while you slowly pull the starter cord with your other hand. Be careful of your fingers! The belt will ride into the groove as the pulley turns. See Photo 6-33B. Slowly give the starter cord an extra pull to make sure that the belt is seated all around both pulleys.

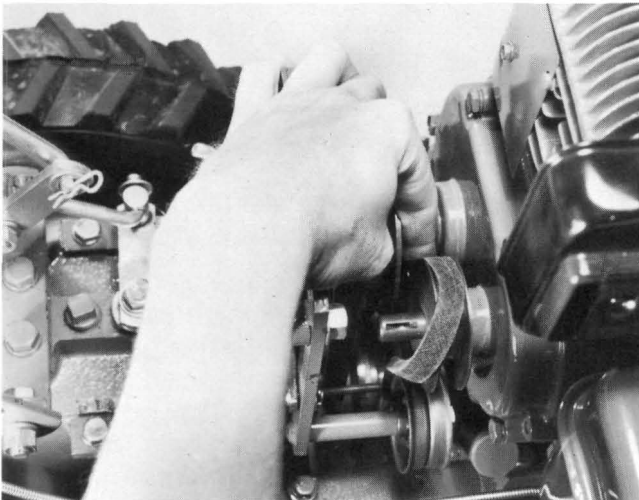

(Photo 6-33B) Hold belt here, slowly pull starter rope.

Now that your Pony has its new belts, you can replace the reverse belt guide, put the belt cover on and reconnect the spark plug wire.

KEEPING THE DRIVE LINKAGE WORKING ITS BEST

Now that you've put fresh belts on your Pony, it's a good time to look over the rest of the drive linkage. There are a few things you can do to get nice smooth action. First, you'll want to check to see that the whole linkage is well lubricated. Your Pony Owner's Manual tells you (on Page 46-47) all the places you should oil. There's one place where a good quality grease works better than oil, however, the connecting rod. To grease the rod, put the Forward/Reverse Lever in FORWARD. Scoop up a little grease with your finger or a screwdriver and spread it liberally around the rod near the swivel, as shown in Photo 6-33C. The grease will automatically work in as you use the Pony.

Next, check the locknut that holds the clutch lever. It should NOT be snugged up tight against the lever because it could bind lever action. If you find it too snug, back it off with a 1/2 inch wrench at least half a turn.

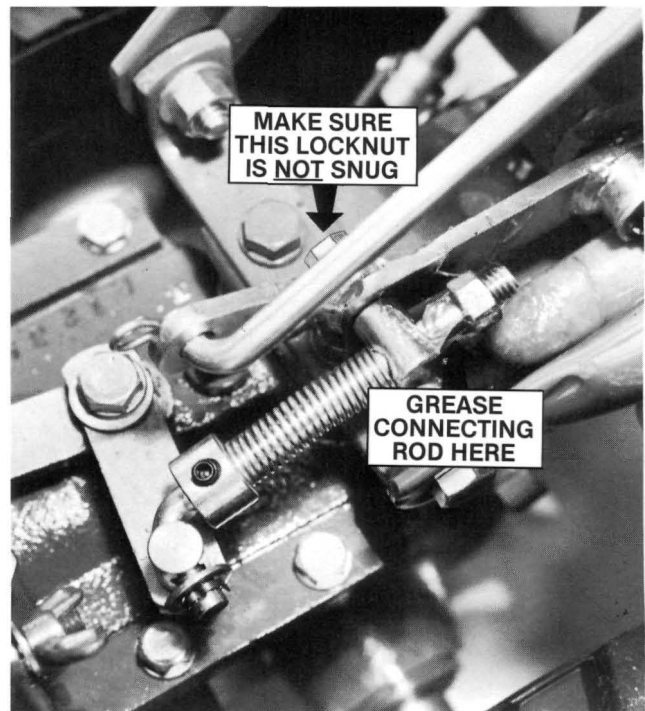

(Photo 6-33C) These two checks can be important!

TROUBLESHOOTING THE ELECTRIC START PONY

Here are a series of simple checks you can make. If your starter motor didn't turn over when you turned the Key Switch to START (with throttle set at start—and away from shutoff position), or if it didn't stop when it should have.

1. STARTER MOTOR WON'T TURN OVER

If your starter motor does not do anything, visually check all wires and cables to make sure that they are snugly connected at the proper points. The exposed ends of each wire should touch only the connection studs. Also you should check the "grounding point" under the right battery clamp bolt on the bottom of the bracket. The cable terminal should make good contact with the bracket metal for a good ground. If not, tighten the connection at the battery bracket. See Sketch 6-34. If rust or corrosion is present around the contact area, scrape the paint or rust off the bracket to get a good connection.

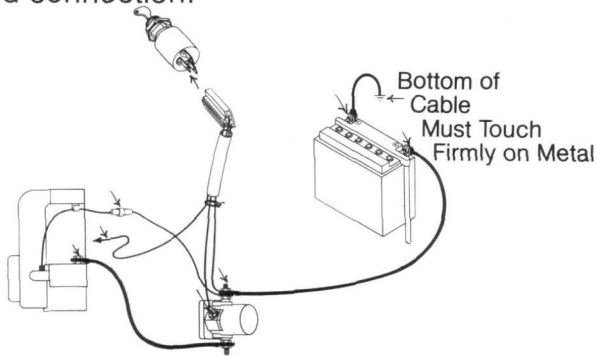

(Sketch 6-34) Check all connections (shown with arrows) for snug fit. Make sure bare terminals touch only posts, not other parts except for the negative cable, which is the ground to the battery bracket.

2. WIRES O.K., STARTER MOTOR STILL WON'T GO

Next, if the service station didn't charge your battery, you may have to charge it briefly to activate it.

CAUTION

For heaven's sake, don't jump the Pony battery with your car's battery or charging system. You'll ruin the Briggs electric start system and possibly its ignition system.

Make sure the tiller's Forward/Reverse Lever is in **NEUTRAL**. Turn the key to **RUN**, pull out the choke, move throttle lever to **START** and **PULL THE RECOIL START ROPE**. Run the engine for 45 minutes or more. Stop the engine and see if the starter motor will start the engine when the key switch is turned to **START**. If it starts, all systems should be in working order now. Remember, battery cells must be full to start and run engine.

3. ENGINE RUNS, STARTER WON'T ENERGIZE

If you ran the engine to charge the battery and the key switch still won't energize the starter motor, this check will help you isolate the problem. First obtain about 12 inches of fairly sturdy **INSULATED** wire (Number 10 wire or larger). Strip insulation away for 1/2 inch on both ends. Remove the negative cable, and replace it with this wire. You'll now use the negative cable as a test jumper wire.

As a precaution, so that the tiller won't start up and move unexpectedly, you should move the engine's throttle lever all the way back to **STOP** or pull the spark plug wire off the spark plug as in Photo 4-8. For safety, the Forward/Reverse Lever should be in **NEUTRAL** when you do this test.

Holding only the insulated part of the cable, touch one end of the cable to the top stud of the solenoid, the stud *to which the positive battery cable is already attached*. Touch the other end to the smaller, silver-colored middle stud shown as **B** in Sketch 6-35. There will probably be a spark. If the starter motor energizes, you know that the battery and solenoid are OK, and you can go to 4.

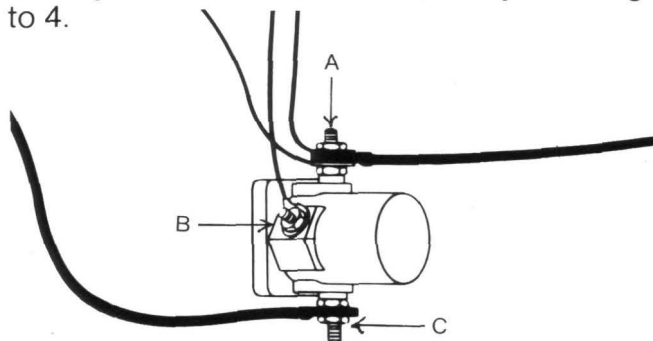

(Sketch 6-35) First touch jumper cable to **A** and **B**. If no reaction, touch **A** and **C**.

If touching those two posts on the solenoid didn't energize the starter, another test on the solenoid will isolate the problem further. Take your test cable, touch the top stud like before and now the bottom stud marked **C** in Sketch 6-35. Again, there may be sparks. If this energizes the motor, it shows that the battery is good but the solenoid is bad. Please contact our Customer Service Department here at the Factory.

If you don't even see any sparks or hear any clicking in the solenoid while you're doing all this, and you've checked for proper hookups and tightness of battery cables, it's a good indication that the battery is dead and you should remove it and

have it tested by your service station. If the battery is bad, please contact us at our Customer Service Department.

You can still use your tiller without the battery, however. See the instructions on page 60 on how to run your tiller with the battery removed or dead.

Finally, take your "test jumper cable", which is the negative battery cable, and put it back on the battery and grounding point.

4. SOLENOID TEST ENERGIZED STARTER, BUT KEY SWITCH DOESN'T ENERGIZE STARTER

At this point, you have either found the problem or you have isolated the problem to the key switch and its wiring if the previous tests *have energized the starter motor*. Here is how to find out if the key switch or its wiring is the culprit.

First, visually check all the wires again. You should have a solid grounding point on the negative battery cable. All wires should be hooked up exactly as the instructions call for, and not be touching other parts. All wire insulation should be intact. Especially check the green wire. It's function is to stop the engine by grounding out the ignition. It should be connected at the stop switch (see Photo 4-3) and to the single part of the receptacle marked C in Sketch 6-36 and nowhere else. Its insulation should be intact.

Now, unplug the receptacle from the bottom of the key switch. Take the wire you used to substitute on the negative side of the battery and stick the ends of the wire into A and B holes in the receptacle as shown in Sketch 6-36, below. If the starter motor energizes, the problem is with the key switch or the contact between the receptacle and the key switch. Make sure the receptacle is firmly connected to the key switch and try to start again.

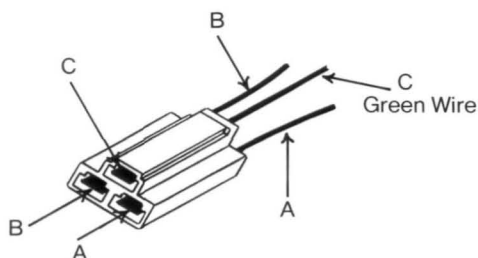

(Sketch 6-36) Receptacle that plugs into bottom of Key Switch. To test for starting, stick jumper wire in A and B. To test for stopping when the engine is running, stick one end of wire in C and touch other end to side of right battery clamp bolt.

If this test does not energize the starter motor, the problem lies within the wiring to

the switch or the starter motor itself. There is a way to check to see if the wiring is connected properly, even then you can't see anything wrong. To do this, you should use a tester (called a continuity tester). You can make one from two D-sized flashlight batteries, some wire and tape and a flashlight bulb, as shown in Sketch 6-37. Or you can buy one at a hardware store.

To test for continuity, place the leads from your tester as shown in Sketch 6-37. If the bulb lights, it indicates that the wire or connection being tested is OK. Check each wire individually. Replace any wires that do not light the flashlight bulb. You can also check the Key Switch with the continuity tester. Just use your leads as shown in Sketch 6-38 to check the Start or Off positions. After checking the wiring completely for good tight connections, insulation and proper hookup throughout, please call our Customer Service Department and describe the situation as completely as possible.

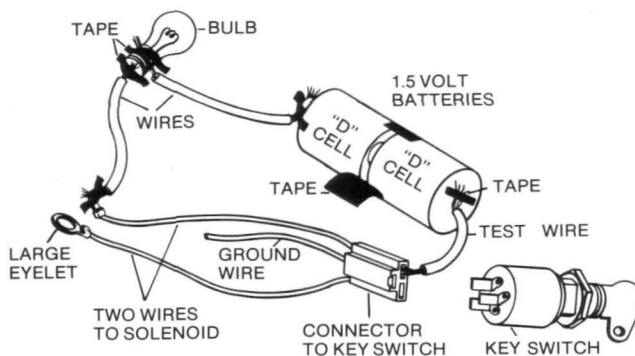

(Sketch 6-37) Make your own tester with three pieces of wire, two "D" cell, 1.5-volt batteries, tape and a flashlight bulb. First test the wire with the small eyelet, (shown tested here) then stick the test wire in the other socket below and the other end of the test wire on the large eyelet. Proper continuity should light the bulb.

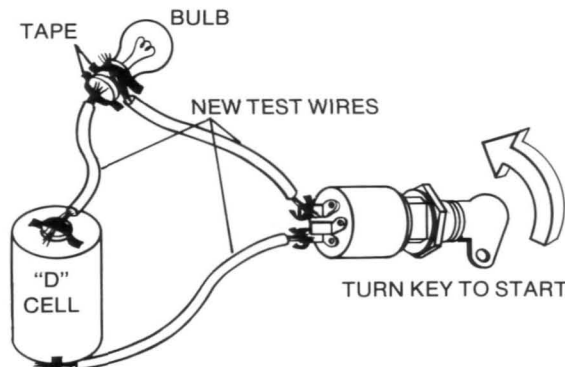

(Sketch 6-38) To test the switch, tape ends of test wire to side-by-side prongs on key switch, then turn switch to START. START should light bulb. Only one battery is shown here . . . you can use two if you want.

IF THE KEY SWITCH WON'T STOP THE ENGINE

The Pony has been designed with two ways to *stop* the engine:

1. Turn the Key Switch to the OFF position
2. Pull the throttle lever at the handlebar control area all the way back to the STOP position.

Both ways stop the engine by "grounding out" the ignition system through the special wiring connection underneath the carburetor.

If your key switch does NOT shut the engine off, here's what to do. First check the green wire that leads from the receptacle to the clip underneath the carburetor (which is near the gas tank). There should be a good connection both at the carburetor and the key switch receptacle. If not, correct it so the wire has a good connection. Next, unplug the receptacle from underneath the key switch. Using your jumper wire, stick one end in the single hole of the receptacle marked "C" in Sketch 6-36 and touch the other end to the right battery clamp bolt. If that stops the engine, go on to check the switch.

To check the switch, remove the key switch using big pliers or a 7/8's inch wrench. To shut the engine off, the washer underneath the nut must be contacting bare metal, and if the decal instructions block that metal-to-metal connection, scrape some of the decal away so good contact is made. Replace the switch and test . . . there should be no problem if proper grounding connection is made. If it still doesn't work, please contact our Customer Service people here at the Factory.

IN CASE OF A DEAD BATTERY

If your Battery is Dead, or one or both battery cables is disconnected, your recoil starter can be used to run the tiller, but only after you have taken the following steps to protect your electrical system.

1. Make sure that all battery cells are full of battery acid—right up to the upper level as marked on the battery when the battery is level. If the engine is run with a dry battery (or one low in acid), the battery and other electrical parts can be damaged.
2. **IMPORTANT:** Disconnect the fuse holder, remove the fuse and tape over the fuse holder's half nearest the engine to protect the diode. See Photo 6-39.

3. Unplug the receptacle under the key switch by pulling down on plastic, not wires. See Photo 6-40.

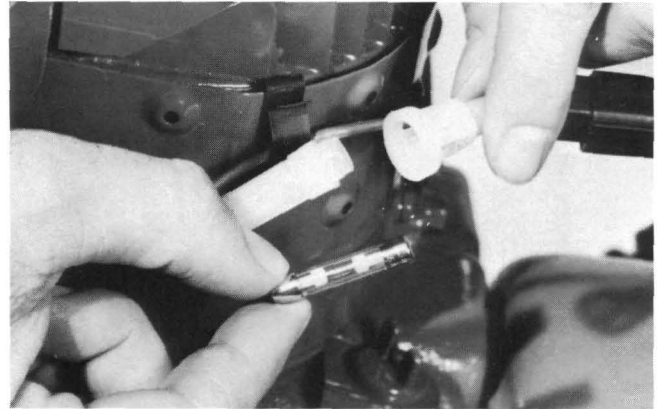

(Photo 6-39) Remove fuse by twisting and pulling the holder, then take out fuse.

BATTERY MAINTENANCE

1. Check electrolyte level and specific gravity periodically. If the level is low, fill to the upper level with distilled or demineralized water. If the specific gravity is less than 1.225, recharging is required. Gas stations will check specific gravity for you.
2. Keep battery terminal and connections tight, and clean them with vaseline or oil.
3. If battery will not be used during the winter months, it should be removed and stored, fully charged, in a cool, dry place. Any collection of grease or other substance should be removed from the top of the battery.

The battery may have to be recharged when used infrequently during the winter or whenever the specific gravity is less than 1.225. We recommend your local service station do this for you (see pg. 14 for more specifics). Before reinstalling the battery in the spring, it should be given a thorough recharging. Remember, a battery that doesn't seem to function properly may not be worn out or defective.

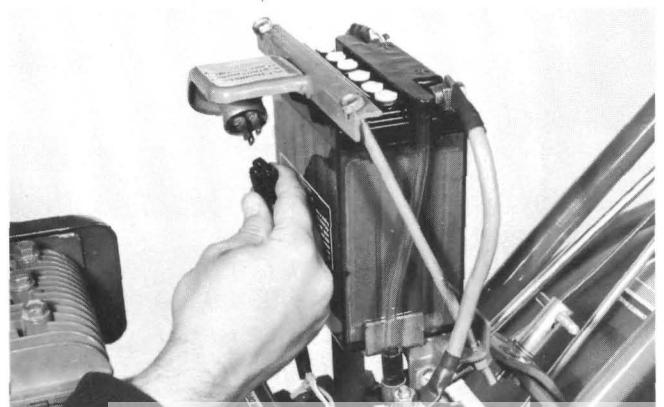

(Photo 6-40) Unplug receptacle to use recoil starter.

PONY MODEL TROY-BILT TILLER SPECIFICATIONS

HORSEPOWER: 5HP Briggs and Stratton engine, horizontal shaft, 4-stroke cycle. Recoil Starting, with a manual choke: Engine Model 130292. Electric Starting, with a manual choke: Engine Model 130297.

SPEEDS: At 3000 RPM (revolutions per minute) engine speed, the Pony ground speed and tiller tine speeds are:

BELT POSITION

	Low	High
GROUND SPEED	0.6 MPH (50 ft./min.)	0.8 MPH (68 ft./min.)
TILLER TINE SPEED	146 RPM	200 RPM

Tine revolutions to each turn of the wheel: 9.2 to 1 (low and high)

DIMENSIONS:

Height:	Without handlebars	22½"
	Handlebar in Down Position	44"
	Handlebar in Highest Position	53"
Length:	With Handlebars	57"
	Without Handlebars	43"
Width:	Hood Width	15"
	Tilling Width	14½"
	Widest at top of Handlebars	20"

WEIGHT:	5 HP Pony Tiller (Recoil Start), less shipping container	160-lbs.
	5 HP Pony Tiller (Recoil Start), with shipping container	197-lbs.
	5 HP Pony Tiller (Electric Start), less shipping container	185-lbs.
	5 HP Pony Tiller (Electric Start), with shipping container	216-lbs.

FUEL: Clean, fresh low-lead or leaded "regular" grade automotive gasoline. Tank capacity: 3 quarts. Fill tank completely. DO NOT use no-lead gas.

MOTOR OIL, ENGINE CRANKCASE: SE or SF classified motor oil, #30 viscosity. Capacity: 1¼ pints. Fill oil tube to overflowing. DO NOT mix with gasoline.

GEAR OIL, TILLER TRANSMISSION: SAE #90 or SAE #140 gear oil. Capacity: 3¼ pints (52 to 54 ozs. is acceptable)

LUBRICATION, EXTERNAL PARTS —

GREASE: A good quality metal-lubricant grease or all-purpose grease recommended for wheel shaft, Forward/Reverse sliding linkage and connecting rod, depth adjustment bar, handlebar height T-bar screw. Any good grade of grease can be substituted.

MOTOR OIL: May be used for the engine throttle cable, all pivot points for the Forward/Reverse lever linkage, spring and plunger for depth regulator, clutch yoke shaft (external part).

BEARINGS:

- Main Drive Shaft:** tapered roller bearings, in front and rear.
- Tiller Shaft:** tapered roller bearings, on each side.
- Pinion Drive Shaft:** ball bearings.
- Wheel Shaft:** bronze bushings.

WHEELS:

Welded steel wheels (12-inch tires), each with tractor-tread, 12 x 3, semi-pneumatic tire directional-mounted. (You do not have to put air in the tires, but if you remove the wheels, it is important to put each back on the same side from which you took it to make sure the "V" formed by the tire treads faces forward.)

TRANSMISSION:

Cast iron case, steel drive pinion gear and spur gears with hardened teeth, cast iron wheel drive worm gear, steel drive shaft and hardened worms.

TILLER HOUSING:

Cast iron tiller housing, bronze tiller worm gear driven by steel worm.

TINES:

16 Bolo tines, which are the best all-purpose tines. They are separately mounted on removable steel tine holders. Holder is removed quickly by removing one bolt.

DEPTH REGULATOR:

Has six functioning positions for instant selection of tilling depth. "Travel" position clears tines 1" to 2" above lawns, driveways, or floors.

HANDLEBARS:

Quickly adjustable up or down without tools by resetting the T-bar screw in one of four holes in the curved height adjustment bar.

ENGINE THROTTLE:

The remote engine throttle control is mounted on the right side of the handlebar control panel. Stop position activates the shutoff switch on the engine throttle. Throttle positions provided for start, slow, and fast. The manual choke on the engine is used in starting. When not in use, a V-notch in the engine cover provides a place to ground the spark plug wire to guard against accidental starting of the engine.

INDEX

DESCRIPTION

SECTION PAGE

DESCRIPTION

SECTION PAGE

A

Air Cleaner —	(4)	27
Importance	(4)	27
Cleaning	(6)	45
Attaching Control Levers	(1)	10, 11
Attaching Handlebars	(1)	7
Attaching Throttle	(1)	8

B

Battery —		
Activation	(1)	14
Installation	(1)	14-17
Venting	(1)	17

Belts —		
Changing Speeds	(5)	38
Belt Cover	(5)	38
Belt Replacement	(6)	52-57
Bolo Tines	(5)	35
Removing and Replacing	(6)	51
Bolts—Tightening	(6)	49

C

Choke Operation	(4)	26
Claims—Freight	(1)	5

D

Depth Regulator —		
Function & Use	(2)	21

INDEX

DESCRIPTION	SECTION	PAGE	DESCRIPTION	SECTION	PAGE
Travel Position	(2)	21	Use	(5)	41
Use	(5)	30, 31			
E			I		
Electric Start System—			Instructions (on hood)	(5)	26
Assembly	(1)	12-17			
Starting and Stopping	(4)	27	J K		
	(5)	29	L		
Troubleshooting	(6)	58-60	Leaks—Oil	(6)	50
Engine—			Lubrication Points	(6)	46
First Oil Change	(4)	27	Oiling	(6)	47
Warranty	(4)	25	Greasing	(6)	48
Model, Type, Code	(4)	25			
Oil	(1)	7	M		
	(4)	25	Maintenance—		
	(6)	44	Air Cleaner	(6)	45
Oil Drain	(6)	44	Cooling System	(6)	45
Service	(4,6)	25, 44	Engine	(6)	44
	(6)	43	Lubrication Points	(6)	46-48
Shutoff Switch	(4)	26	Oils	(6)	43
	(4)	27	(or see Oil—Engine or,		
Starting	(4)	27	Oil—Transmission)		
Exhaust Gas Caution	(4)	27	Oil Leaks	(6)	50
				(6)	51
F			Tightening Bolts	(6)	49
Factory Rebuilding			Missing Parts	(1)	5
Agreement, Half Price	Inside Back Cover		Model Number—Engine	(4)	25
Forward/Reverse Lever—	(2)	19	Motor Oil—Type & Capacity	(1)	7
Attaching	(1)	10	(also see Oil, Engine)		
Operation	(2)	19	Muffler—Spark Arrester Type	Inside Front Cover	
	(5)	30			
Safe Usage Tip	(3)	24	N		
Free Wheel, Caution	(3)	24	Nuts and Bolts—Tightening	(6)	49
	(2)	18			
Freight Damage	(1)	5	O		
Fuel—Requirements	(4)	26	Oil, Engine—		
Capacity	(6)	61	Adding	(6)	44
			Capacity	(1)	7
G				(6)	44
Gear Oil—			Changing	(6)	44
Transmission	(1)	6	Intervals	(6)	44
	(6)	43	Level	(1)	7
Type & Capacity	(6)	43	Type	(1)	7
				(6)	44
			Specifications		61
H			Oil, Gear—Transmission—		
Handlebars—			Adding	(1)	6
Attaching	(1)	7, 8		(6)	43, 44
Height Adjustment	(1)	8	Capacity	(6)	43
Hiller/Furrower Attachment	(5)	40		(6)	44
Assembly	(5)	40		(6)	44

TILLER WARRANTY TRANSFER CARD

If Tiller is sold or transferred, please fill in this card and send it to us so we can transfer the NO-TIME-LIMIT PROMISE to the new owner. Thank you!

Tiller Serial Number

Engine Horsepower Tiller Model: Horse or Pony Std. or Elec.

Original date of purchase (shipping date) Month/ Day/ Year

New Owner

Former Owner

First Name Middle Initial Last Name

First Name Middle Initial Last Name

Street & Number (or R.R. & Box Number)

Street & Number (or R.R. & Box Number)

City State

City State

County Zip

County Zip

Area Code Phone Number

Area Code Phone Number

Save this card until needed
Troy-Bilt® Roto Tiller-Power Composter

SHP-4

BrentChalmers.com
©1997 Garden Way, Inc.



NO POSTAGE
NECESSARY
IF MAILED
IN THE
UNITED STATES

BUSINESS REPLY MAIL

FIRST CLASS

PERMIT NO. 6

TROY, N.Y.

POSTAGE WILL BE PAID BY ADDRESSEE

GARDEN WAY MANUFACTURING CO.

Builders Of
TROY-BILT® Roto Tiller-Power Composters
102nd Street and Ninth Avenue
Troy, New York 12180

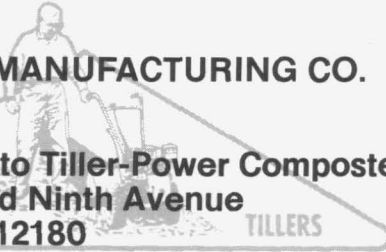

BrentChalmers.com

LIMITED WARRANTY

NO TIME LIMIT

Your Troy-Bilt Roto Tiller-Power Composter and all attachments will be carefully inspected and tested at the factory. We, or your Dealer, will at any time replace any part which is defective in materials or workmanship—except for the engine (which is warranted by the engine manufacturer for 1 year; write us for details).

PLUS...

Please write or call us if you have any problems. If you are not entirely pleased and satisfied with your Troy-Bilt Roto Tiller-Power Composter any time within 30 days after you first use it in your garden, you may notify us or your Dealer and return it for full refund less shipping costs.

Even after your first 30 days of use, if you ever have any problems, we will make good even if it means sending you a completely new machine or having you return machine, parts, or attachments for exchange, repair or full refund of purchase price, whichever you prefer...except for shipping costs and an allowance for normal wear and tear.

This warranty gives you specific legal rights, and you may also have other rights which vary from state to state.

HALF-PRICE FACTORY REBUILDING AGREEMENT

At any time, no matter how new or old your TROY-BILT Roto Tiller-Power Composter may be, we will rebuild and repaint it, replacing every worn part (such as bearings, gears, seals, tines, belts and including a new engine) for one-half the current retail price at the time of repair of that model or its equivalent (if that exact model has been changed); owner to pay shipping and container costs to and from Factory. If any other than wearing parts need replacement, an estimate will be submitted to owner for approval. This offer, of course, is subject to fire, war, strikes, and other contingencies beyond our control.

The whole sense and purpose of our Direct-From-The-Factory Savings Plan, our no-time-limit promise and Half-Price Factory Rebuilding Agreement are to provide owners of TROY-BILT Roto Tiller-Power Composters an outstanding value both as to purchase price and maintenance cost of Rotary Tillers and attachments especially designed and built for their purposes—in return for their cooperation in spreading the good word about the Troy-Bilt to other serious gardeners—to our great and genuine mutual benefits.

Yours for good faith and fairness in all matters.



Dean Leith, Jr., Sales Manager

Garden Way Manufacturing Company

102nd. Street & 9th Avenue, Troy, New York 12180 • Tel. (518) 235-6010

BrentChalmers.com

RETURN ORGANIC MATTER TO SOIL To Replenish It For What You Took From It!



Till under cornstalks while they're still lush and green.



Later passes will completely bury residue for nutrient value.



After knocking down stalks, till back over them in other direction.



In idle ground, plant a cover crop like buckwheat to supply rich organic material when tilled in.

TROY BILT

ROTO TILLERS

GARDEN WAY MANUFACTURING COMPANY
TROY, NEW YORK 12180

BrentChalmers.com