



Owner/Operator Manual

PTO HORSE[®] Tiller

- Safety
- Assembly
- Features and Controls
- Operation
- Maintenance

Models

- 12087 (7HP Standard)
- 12088 (7HP Electric)
- 12089 (8HP Standard)
- 12090 (8HP Electric)



TROY-BILT

Dear Owner,

You now own one of the finest rear-tine rototillers available. Your new PTO Horse Model tiller allows you to till and cultivate your garden with ease, and accomplish dozens of other property management projects as well. Its PTO capability allows it to power a variety of attachments, including a chipper/shredder and a generator. Your tiller is famous for its ruggedness, performance and high-quality engineering. We know you'll enjoy using it.

Please carefully read this Manual. It tells you how to safely and easily assemble, operate and maintain your machine. *Be sure that you and any other operators carefully follow the recommended safety practices at all times. Failure to do so could result in personal injury or property damage.*

Of course, if you should ever have any problems or questions, or for a free replacement copy of this Manual, please contact your local authorized service dealer or call us Toll-Free. Our telephone numbers and mailing addresses are listed on Page 4 and on the back cover of this Manual.

We want to be sure that you are completely satisfied at all times.

*Your Friends
at Troy-Bilt*

This machine meets voluntary safety standard B71.8 – 1986, which is sponsored by the Outdoor Power Equipment Institute, Inc., and is published by the American National Standards Institute.



This is a safety alert symbol. It is used in this Owner/Operator Manual to alert you to potential hazards. Whenever you see this symbol, read and obey the safety message that follows it. Failure to obey the safety message could result in personal injury or property damage.

Be Sure To Return Your Owner Registration Card

Be sure to fill out and return your Owner Registration Card, which is located in your literature package. The information contained on this card will register your machine with us and entitle you to full coverage under our Full No-Time-Limit Warranty.

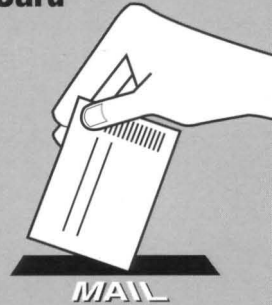

NOTE: A Warranty Transfer Card is included in this Manual. This card should be filled out and returned to us ONLY if you transfer ownership of your machine to someone else.



WARNING:

The engine exhaust from this product contains chemicals known to the State of California to cause cancer, birth defects, or other reproductive harm.

Table of Contents

Owner's Record

Please write the Model and Serial numbers of your machine in the spaces provided. You can find the location of these numbers by referring to the illustration below.



Model Number:

Serial Number:

Model and Serial Number location

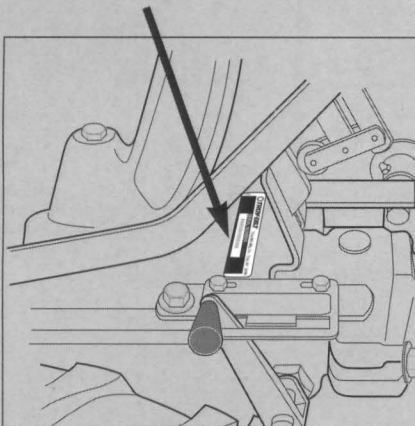

SERVICE INFORMATION	4
SECTION 1: SAFETY	5
Training	5
Preparation	6
Operation	6
Maintenance and Storage	8
Decals	8
SECTION 2: ASSEMBLY	9
SECTION 3: FEATURES AND CONTROLS	20
Tiller Features and Controls Identification	20
Engine Features and Controls Identification	23
SECTION 4: OPERATION	24
Break-In Operation	25
Test Forward Interlock Safety System	26
Starting and Stopping the Engine	27
Cold Weather Operation	28
To Operate Tiller	29
Turning Around	30
Transporting Your Tiller	31
To Change Belt Speeds	32
Tilling in the Garden	34
The PTO Power Unit	40
SECTION 5: MAINTENANCE & REPAIRS	44
Required Maintenance Schedule	44
Tighten Bolts and Nuts	45
Tiller Lubrication	46
Transmission Gear Oil Maintenance	46
Drive Belt Maintenance	49
Reverse Drive Maintenance	52
Bolo Tine Maintenance	54
Tine Shaft Maintenance	56
Tire and Wheel Maintenance	56
Engine Oil Maintenance	56
Air Cleaner, Throttle Cable, Ignition System, Spark Plug	57
Battery Care	58
Storing the Tiller	60
Inspect Forward Interlock Wiring System	60
Troubleshooting Forward Interlock Safety System	60
TROUBLESHOOTING PROCEDURES	61
ATTACHMENTS & ACCESSORIES	64
TILLER SPECIFICATIONS	65
INDEX	66
NO-TIME-LIMIT WARRANTY	Back Cover

We're at Your Service!

HOW TO REACH US

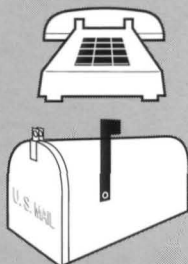

Address

U.S.A.

Garden Way Incorporated,
102nd St. & 9th Ave.,
Troy, N.Y. 12180

Canada

Garden Way Incorporated,
320 Van Sickle Rd., Unit 12,
St. Catherines, Ont. L2R 6P7

Hours

U.S.A.

Mon.-Fri.,
8 A.M. to 7 P.M.
Saturday
9 A.M. to 4 P.M.

Canada

Mon.-Fri.,
8 A.M. to 4:30 P.M.

Telephone Numbers

U.S.A.

(Toll Free)

For Technical Service:
1-800-520-5520

For Parts Service:
1-800-648-6776

Overseas callers may use:
518-391-7000

Canada

(Toll Free)

For Technical Service and Parts Service:
1-800-225-3585



If you have any Questions or Problems...

...Please contact your local TROY-BILT® Tiller authorized dealer or call or write the Factory. When calling or writing, please be sure to provide the Model and Serial Numbers of your machine (refer to Page 3).

If You Need Engine Service:

If your engine should ever require service or repair, contact your nearest authorized engine service dealer.

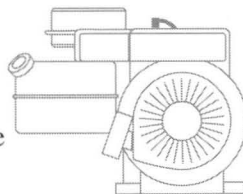

To find the name and address of your nearest authorized engine service dealer, look in the Yellow Pages of the telephone book under

“Engines-Gasoline” (call us if you need assistance in obtaining engine service or parts).

Please remember that your engine is covered by the engine manufacturer’s Limited Warranty. Any unauthorized work performed on the engine during the warranty period may void the warranty. For full details on the engine manufacturer’s Limited Warranty, refer to the separate Engine Owner’s Manual.

If You Need Parts:

Factory specified replacement parts for your machine are available from either your TROY-BILT® Tiller authorized dealer or directly from the Factory.

To order a part from the Factory, refer to your separate Parts Catalog to find the part

number, description, and quantity of the part you need. Then, call or write our Parts Department, being sure to provide the Model and Serial Numbers of your machine.

Our trained parts specialists will gladly assist you if you have any difficulty in identifying the part that you need.

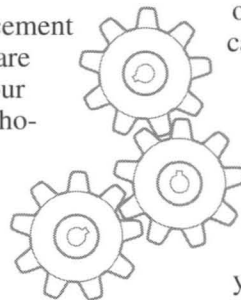

Section 1 Safety

Read Me First!

Please read and follow all of the safety rules in this Safety Section. Failure to comply could result in serious personal injury or property damage.

If you should lend this equipment to another person, make sure that he or she reads, understands, and always follows these safety instructions.

If you are not completely sure about any of the information found here or elsewhere in the Manual, please contact either your local authorized dealer or the factory for assistance.



This is a safety alert symbol. It is used in this Owner/ Operator Manual and on your equipment to alert you to potential hazards.

Whenever you see this symbol, read and obey the safety message that follows it. Failure to obey those safety messages could result in serious personal injury or cause property damage.

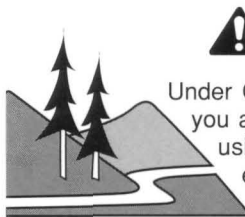

WARNING TO ALL CALIFORNIA AND OTHER POWER EQUIPMENT OPERATORS

Under California law, and under the laws of several other states, you are not permitted to operate an internal combustion engine using hydrocarbon fuels on any forest-covered, brush-covered, or grass-covered land, or on land covered with grain, hay, or other flammable agricultural crop, without an engine spark arrester in continuous effective working order.

The engine on your power equipment, like most outdoor power equipment, is an internal combustion engine that burns gasoline, a hydrocarbon fuel. Therefore, your power equipment must be equipped with a spark arrester muffler in continuous effective working order. The spark arrester must be attached to the engine exhaust system in such a manner that flames or heat from the system will not ignite flammable material. Failure of the owner/operator of the equipment to comply with this regulation is a misdemeanor under California law, and may also be a violation of other state and/or federal regulations, laws, ordinances, or codes. Contact your local fire marshal or forest service for specific information about what regulations apply in your area. Contact your authorized engine dealer for information about obtaining a spark arrester.

TRAINING



1. Read this Owner/Operator Manual and the separate Engine Owner's Manual carefully before operating this equipment. Be completely familiar with the controls and the proper use of this equipment. Know how to stop the unit and disengage the controls quickly.
2. Never allow children or untrained adults to operate this equipment.
3. Keep the area of operation clear of all persons, particularly small children and pets. Keep bystanders at least 25 feet away from the area of operation.



4. Familiarize yourself with all of the safety and operating decals on this equipment and on any of its attachments or accessories.

5. Do not run engine in an enclosed area. Engine exhaust contains carbon monoxide gas, a deadly poison that is odorless, colorless, and tasteless.

6. Do not allow hands or any other part of the body or clothing near the rotating tines or near any other moving part. The tines begin to rotate

forward once the engine starts, the Tines/PTO Clutch Lever is in the ENGAGE

position, the Forward Interlock Levers are squeezed closed and the Wheels/Tines/PTO Drive Lever is shifted to FORWARD. The tines rotate in Reverse whether the Interlock Levers are squeezed closed or left open.



Safety

7. Before inspecting or servicing any part of the equipment, shut off the engine, wait for all moving parts to come to a complete stop, disconnect spark plug wire from

spark plug and move wire away from the spark plug.

alcohol, medication, or when you are tired or ill.

8. Do not operate this equipment if you are under the influence of

PREPARATION



1. Thoroughly inspect the area where the tiller will be used. Remove foreign objects before tilling.

2. Put the Wheels/Tines/PTO Drive Lever in NEUTRAL before starting the engine.

3. Do not operate the tiller without wearing suitable clothing. Avoid loose garments or jewelry that could get caught in moving parts of the tiller or its engine.

4. Do not operate the tiller when you are barefoot, in sandals, sneakers or other light footwear.

Wear shoes that grip well on slippery surfaces.

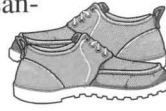

5. Do not till near underground electric cables, telephone lines, pipes, or hoses. Contact your telephone or utility to verify locations of underground cables or lines.

6. Handle gasoline with care; it is flammable, the vapors explosive.

a. Use an approved gas container.

b. Gas cap shall never be removed or fuel added with engine running. Engine shall be

allowed to cool before refueling. Operators shall not smoke.

c. Keep matches, cigarettes, cigars, pipes, open flames, or sparks away from the fuel tank and fuel container.

d. Fill fuel tank outdoors using extreme caution. Never add fuel indoors. Use a funnel or spout to prevent spillage.

e. Replace fuel cap securely and clean up fuel spills before starting the engine.

7. Never attempt to make any adjustments while the engine is running or the spark plug wire is connected, except when so instructed.

OPERATION



1. Do not put hands or feet near or under rotating parts.

2. Use extreme caution when on or crossing driveways, walks or roads. Be alert for hidden hazards or traffic. Do not carry passengers.

3. If you hit a foreign object, stop the engine (remove key on electric start models), let all moving parts come to a complete stop, disconnect spark plug wire and move wire away from the spark plug, and inspect for damage. Repair damage before restarting.

4. Exercise caution to avoid slipping or falling.

5. If abnormal tiller vibration occurs, stop engine immediately, disconnect the spark plug wire and move wire away from spark plug. Check for the cause. Carefully inspect for any damage. Fix the problem before using the tiller again.

6. Stop the engine, remove the key on electric start models, and disconnect the spark plug wire and move wire away from spark plug before leaving the operating position, unclogging tines, or making repairs, adjustments or inspections.

7. Before leaving tiller unattended, shift to NEUTRAL, stop engine (remove key on electric start models), and disconnect spark plug wire and move wire away from plug to prevent accidental starting.

8. Before cleaning, repairing or inspecting, stop the engine (remove

key on electric start models), let all moving parts stop, and disconnect spark plug wire and move wire away from spark plug to prevent accidental starting. For electrical safety on electric start models, always disconnect the negative (-) cable from the battery post.



9. Flap on tine hood must be down when running tiller, unless using the hiller/furrower attachment.

10. Never operate the tiller unless safety guards or other protective devices are in place.

11. Do not run the engine in an enclosed area. Engine exhaust contains carbon monoxide gas, a deadly poison that is odorless, colorless, and tasteless.

12. Keep children and pets away.

13. Never operate the tiller under engine power if the Wheel Speed Lever is in the FREE WHEEL position. In FREE WHEEL, the wheels will not hold the tiller back and the revolving tines could propel the tiller rapidly, possibly causing loss of control. Always engage the Wheel Speed Lever in either FAST or SLOW position before starting the engine or engaging the tines with the Wheels/Tines/PTO Drive Lever.

14. The tiller could unexpectedly bounce upward or jump forward and be propelled away from you if the tines strike or catch very hard-packed soil, sod, frozen ground, or any buried obstacle such as large stones or roots. If in doubt about tilling conditions, use the following precautions to assist you in maintaining tiller control:

- a. Walk behind and on either side of the tiller, using one hand on the handlebars. Relax your arm, but use a secure hand grip.
- b. Use shallow depth regulator settings, gradually working deeper with each tilling pass.
- c. Use slower wheel, tine and engine throttle speeds.
- d. Clear the tilling area of big stones, roots and other debris.
- e. Avoid putting downward pressure on the handlebars. If necessary, apply slight upward pressure to prevent the tines from digging too deeply.
- f. Avoid contacting hard-packed soil or sod at the end of a row by reducing engine speed and lifting handlebars up to raise tines out of the soil.
- g. In an emergency, stop the tines and wheels by shifting the Wheels/Tines/PTO Drive Lever to NEUTRAL. If you can not reach the lever or have lost control of the tiller, **let go** of the handlebars and all controls. Do not try to restrain it.

15. Do not overload the machine capacity by trying to till too deeply at too fast a rate.

16. Never use the tiller at high ground speeds on slippery surfaces.

17. Do not operate tiller on a slope too steep for safety. On slopes, slow down and be sure you have good footing. Don't let the tiller "free-wheel" down slopes.

18. Clear the area of bystanders before tilling.

19. Use only attachments and accessories approved by Troy-Bilt Manufacturing Company.

20. Use tiller attachments and accessories when recommended.

21. Never operate the tiller without good visibility or light.

22. Never operate the tiller if you are fatigued, or under the influence of alcohol, drugs or medication.

23. Operators shall not tamper with the engine-governor settings on the machine; the governor controls the maximum safe operating speed and protects the engine and all moving parts from damage caused by over-speed. Authorized service shall be sought if a problem exists.

24. Do not touch engine parts that may be hot from operation (muffler, fins, etc.). Make certain *all* parts have cooled down before inspecting, cleaning or repairing.

25. POISON/DANGER—CAUSES SEVERE BURNS. The battery on electric start models contains sulfuric acid. Avoid contact with skin, eyes or clothing.
Antidotes: External— Flush immediately with lots of water.
Internal— Drink large quantities of water or milk. Follow with milk of magnesia, beaten eggs or vegetable oil. Call a doctor immediately.
Eyes— Flush with water for 15 minutes. Get prompt medical attention. Keep out of reach of children.

26. DANGER— BATTERIES PRODUCE EXPLOSIVE

GASES. Keep sparks, flame or smoking materials away. Ventilate when charging battery or using in an enclosed space. Always shield eyes when working near battery.

27. Remember—To stop tines and wheels, either put Wheels/Tines/PTO Drive Lever in NEUTRAL, or move Throttle Lever to STOP position. If you lose control of the tiller and can not reach the levers, let go of the handlebars and controls and do not try to restrain the tiller. The Forward Interlock Safety System will stop the engine.

28. Look behind and exercise caution when backing up. For added safety, put Wheel Speed Lever in SLOW position before reversing.

29. When loading or unloading the tiller, always disengage the tines and use slower wheel and engine throttle speeds. Use sturdy ramps wide and strong enough to easily support the tiller (280-to-325 lbs., depending on model) and operator. Never go down ramps in FORWARD drive—the tiller could tip forward, exposing you to the tines (which should be disengaged). Always use REVERSE drive and back down ramps. To go up ramps, use FORWARD drive and walk up following the tiller.

30. The Forward Interlock Safety System should be tested for correct functioning every time the tiller or PTO power unit is used. See Section 4 in this Manual for the test procedure to take.

31. If using the optional Dozer Blade, either remove the tine attachment, or disengage the tines with the Tines/PTO Clutch Lever. Revolving tines are dangerous.

Safety

MAINTENANCE AND STORAGE

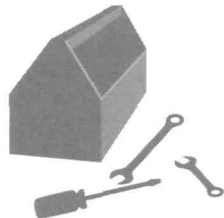

1. Never perform maintenance when engine is running or spark plug wire is connected except when specifically directed to do so.

2. Keep tiller, attachments and accessories in safe working condition.

3. Check all nuts, bolts, and screws frequently for proper tightness. Always verify your equipment is in safe working condition.

4. Never store the machine with fuel in the fuel tank inside a building where fumes may reach an open flame or spark, or where ignition sources are present (such as hot water and space heaters, furnaces, clothes dryers, etc.).

5. Let the engine cool down before

storing it in an enclosure.

6. To reduce fire hazard possibilities, keep the engine free of grass, leaves or grease.

7. Store gasoline in a cool, well-ventilated area, safely away from any spark- or flame-producing equipment. Store gasoline in an approved container, safely out of the reach of children.

8. Refer to the Maintenance section in this Manual for storage information if your tiller is to be stored for an extended period.

SAFETY DECALS

Make certain that all safety decals on this equipment are kept clean and in good condition. The safety decal locations are shown (at a reduced size) below. There are other decals located on your equipment for

operation and controls identification. They are also shown below and in your Parts Catalog. If you need a replacement decal, please refer to the Parts Catalog that accompanied this Manual.

Decal Locations

A) **WARNING: Hot Surfaces decal.** On 8HP Kohler engines (shown), located on top of the engine. On Briggs & Stratton engines (not shown), located on top of the muffler guard.

C) **WARNING: Operating Instructions decal.** Five groups of safety statements are provided along with tiller operating instructions.

E) **Forward Interlock Lever decals (2).**

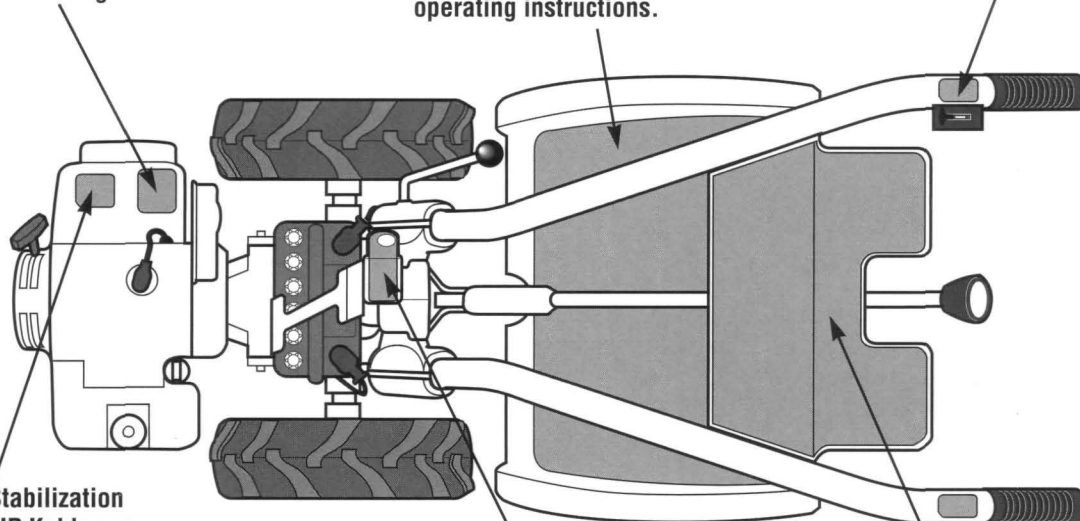

F) **Engine Stabilization decal.** On 8HP Kohler engines (shown), located on top of the engine. On Briggs & Stratton engines (not shown), located on the top, front of the engine cover.

B) **WARNING: Engine Ignition.** Provides safety and operational information for using the Keyswitch Ignition. On electric start models only.

D) **Power Unit Operating Instructions decal.**

Section

2

Assembly



Please carefully follow the steps in this Section to properly assemble your new machine. These steps will not take very long and they will assure you of having assembled your machine correctly.



WARNING

To prevent personal injury or property damage, do not start the engine until all assembly steps are complete and you have read and understand the safety and operating instructions in this Manual.

Tools Needed:

- One 3/8" Open End or Adjustable Wrench
- One 9/16" Open End or Adjustable Wrench
- One 3/4" Open End or Adjustable Wrench
- Two 7/16" Open End or Adjustable Wrenches
- Two 1/2" Open End or Adjustable Wrenches
- One Flat Blade Screwdriver
- Scissors (to trim plastic ties)
- Quality Motor Oil (refer to the Engine Owner Manual provided with your unit for motor oil specifications and capacities).
- Tire Pressure Gauge
- A strong 4 1/2" high prop (a wood box, a brick, or boards)

Subjects covered in this Section:

- Inspection After Delivery
- Unpacking and Checking Contents
- Attach the Handlebars
- Remove Tiller from Shipping Platform
- Connect Forward Interlock Wire Harness
- Attach Wheels/Tines/PTO Drive Lever
- Check Gear Oil Levels in Power Unit and Tine Attachment Transmissions
- Add Motor Oil to Tiller Engine
- Attach Engine Throttle Lever to Handlebar
- Adjust the Air Pressure in the Tires
- Assembling the Electric Start System

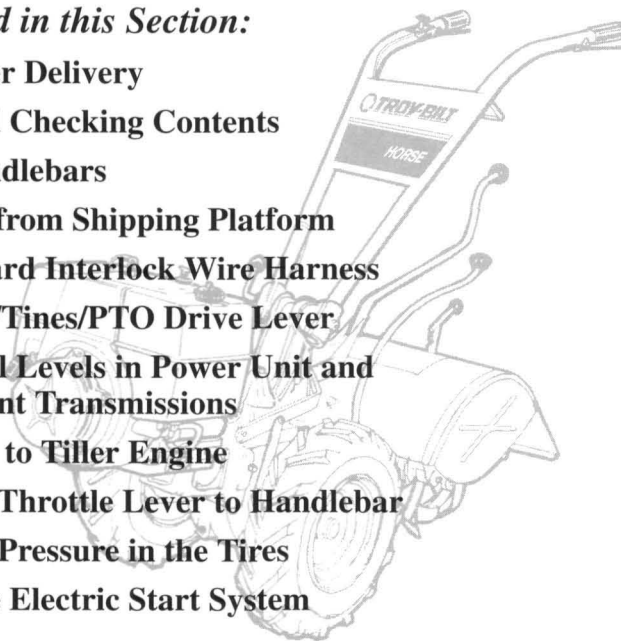

Inspection After Delivery

Inspect your machine immediately after it has been delivered. Make sure that neither the carton nor the contents have been damaged.

If you find or suspect any damage, contact the carrier (trucking company) right away. Inform them of the specific damage and that you wish to file a claim. To protect your rights, be sure to put this in writing to the carrier within 15 days after your machine arrives. The carrier will let you know how to proceed with your claim. Please let us know if you need any assistance with this matter.

IMPORTANT: Motor oil must be added to the engine before it is started. The procedure for adding oil is explained later on in these assembly instructions.

STEP 1: Unpacking Contents

If you haven't done so, unpack and check the loose parts as listed in the table on page 10. Contact us if any parts are missing.

A. Remove the handlebars and the Wheels/Tines/PTO Drive Lever (Items 1 and 2 in Photo 2-1). You may need to cut a plastic tie to free the handlebars from its shipping location. Set them on a clean surface. Do not get dirt on the wire harness plug located at the bottom of the handlebars!

B. Remove the loose parts from the plastic envelope that contained these instructions (Items 3 through 8 in Photo 2-2).

C. If you ordered an Electric Start Tiller, take out the items from a sealed plastic hardware package under the battery clamp (Items 9 through 11 in Photo 2-3). Your ignition keys are in the keyswitch.

Assembly

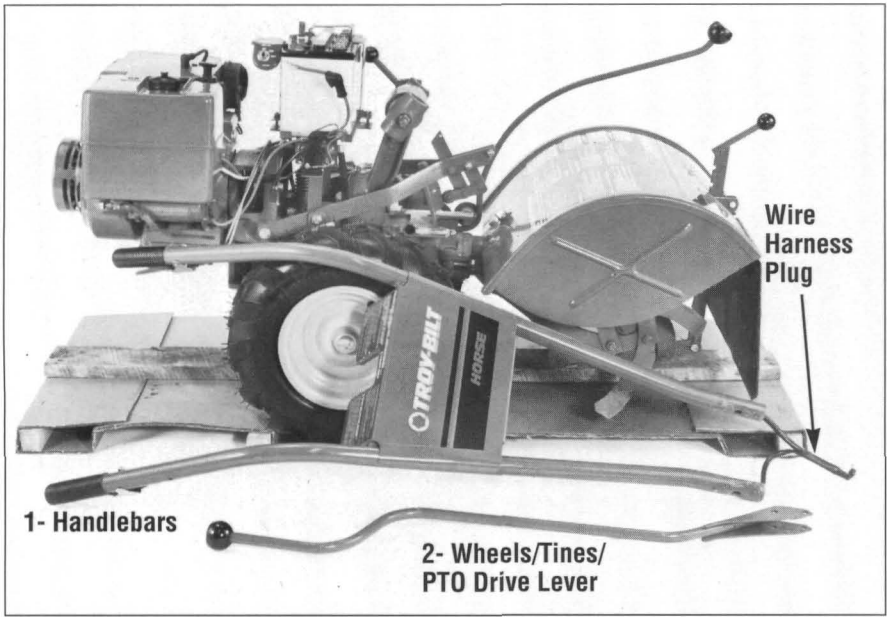

Photo 2-1. Put Handlebars (Item #1) and Wheels/Tines/PTO Lever (Item #2) aside.

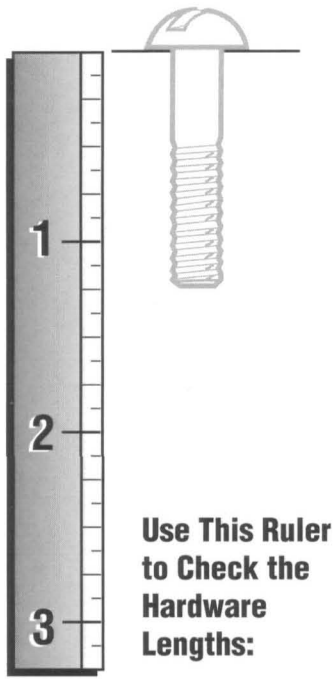

Table 1 – Carton Contents Parts List				FOR MODEL:			
KEY	QTY	DESCRIPTION	7HP Std.	7HP Elec.	8HP Std.	8HP Elec.	
Photo 2-1:							
1	1	Handlebars	•	•	•	•	
2	1	Wheels/Tines/PTO Drive Lever	•	•	•	•	
Photo 2-2:							
3	1	Clutch Pawl Spring	•	•	•	•	
4	1	Belt Adjusting Tool.....	•	•	•	•	
5	2	Plastic Cable Ties.....	•	•	•	•	
6	1	Curved Head Bolt, 1/4"-20 x 2" (Grade 5)..	•	•	•	•	
7	1	Flanged Lock Nut, 1/4"-20	•	•	•	•	
8	1	Panhead Screw, #20 -24 x 1/2"	•	•	•	•	
Photo 2-3:							
9	2	Nuts, 1/4"-20, for battery terminals		•		•	
10	2	Bolts, 1/4"-20 x 5/8", for battery terminals		•		•	
11	1	Battery Vent Tube		•		•	
	2	Keys for Electric Start Models		•		•	
		(located in ignition keyswitch)					

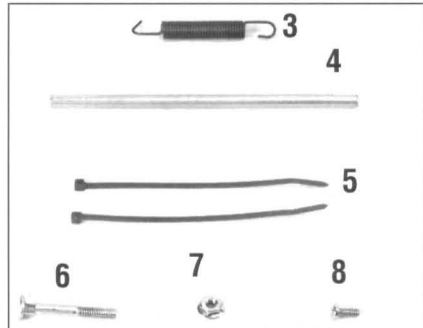

Photo 2-2. Parts inside the literature envelope.

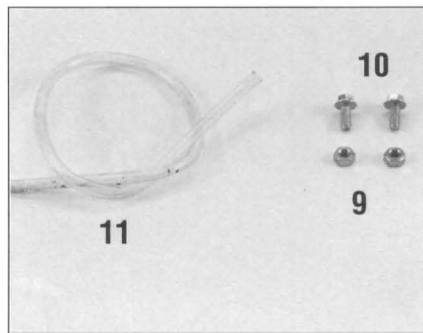

Photo 2-3. Parts for Electric Start Tiller models. (Ignition keys are not shown.)

STEP 2: Attach the Handlebars

Do not move tiller off shipping platform unless handlebars are attached. This makes moving the tiller easier and more controllable.

All the parts shown in Figure 2-4 (except the handlebars) are shipped assembled. You must disassemble these parts in order to attach the handlebars.

A. Unwind the Handlebar Height Adjustment Lever (Figure 2-4) counterclockwise. Be prepared to catch the nut, left clamp and left ratchet as you remove the lever.

Completely withdraw the lever, taking with it the right clamp and right ratchet. Keep mating clamps and ratchets grouped together.

B. Place the handlebar ends on either side of the handlebar base and the wire harness at the bottom of the handlebars at the rear of the base (Fig. 2-4).

C. Hold the right-side ratchet and right-side clamp in position next to right handlebar arm. Insert adjustment lever through the clamp, handlebar, ratchet and the base. Let the adjustment lever protrude from the other side of the base.

Note: The lever should pass freely through the holes in the handlebar ends. If it won't—do not force it. The wires to the Forward Interlock Safety System may be blocking the lever. Push a pencil through the holes to gently move the wires aside.

D. Position the left-side ratchet and left-side clamp next to the left handlebar arm (see Fig. 2-4). Move the adjustment lever all the way through these parts. Hold the nut in place and screw the lever into it. Don't fully tighten the lever yet.

E. Raise the handlebars (jiggling them on the ratchets helps) to one of two pre-set height settings. Then tighten the lever (Photo 2-5).

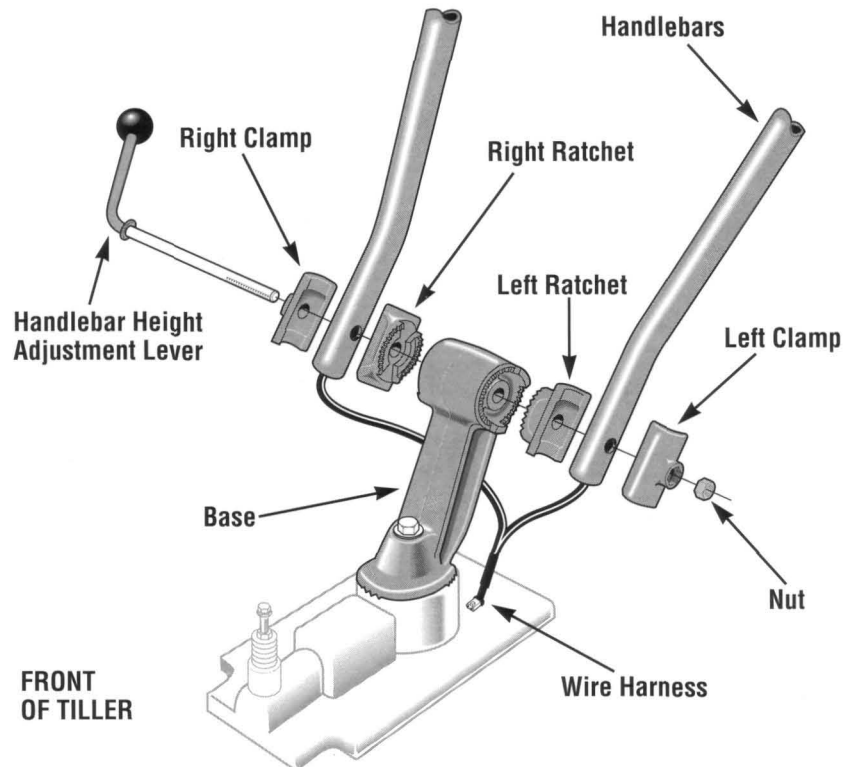

Figure 2-4. Unwind the Handlebar Height Adjustment Lever to separate the handlebar assembly parts. Keep the mating left-side ratchet and clamp grouped together, and the right-side ratchet and clamp grouped. Place the handlebars so the ends are on either side of the handlebar base. Reassemble all parts securely.

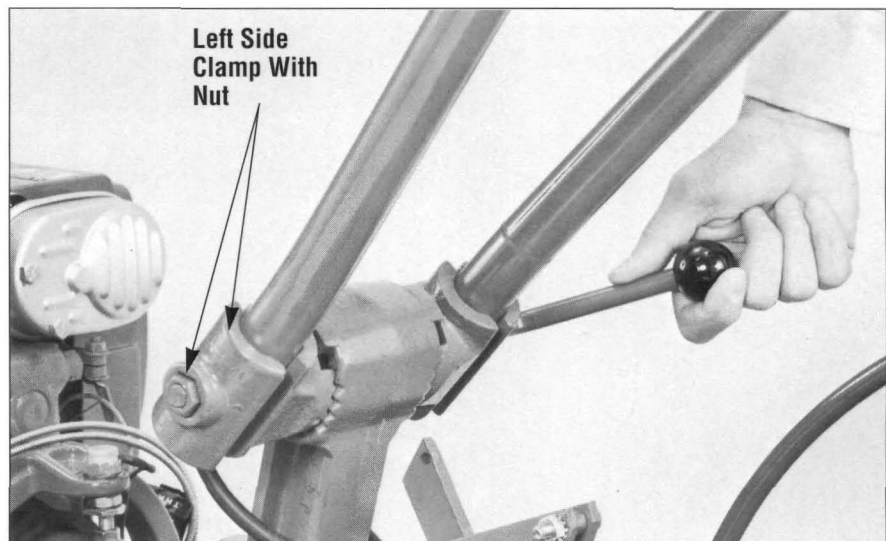

Photo 2-5. When handlebars are in position, reassemble all the components. Insert the Handlebar Adjustment Lever from right to left through all the parts. As shown above, securely tighten the lever.

Assembly

STEP 3: Remove Tiller from Shipping Platform

A. The Depth Regulator Lever (Photo 2-6) may be secured to its own mounting bracket with a plastic tie strap. Removing the tie strap lets you move the Depth Regulator Lever up or down. To check, lift the hinged flap at the end of the hood and look for a tie strap around the lever. Use a scissors to cut it loose.

B. Move the Wheel Speed Lever (Photo 2-6) to FREEWHEEL position which lets the wheels turn

freely. FREEWHEEL position is midway between SLOW and FAST positions. Then lift the handlebars up to clear the tines from the platform. Pull the handlebars firmly back to roll the wheels out of the platform wheel wells.

C. Roll the tiller to a level area where you can complete the assembly steps.

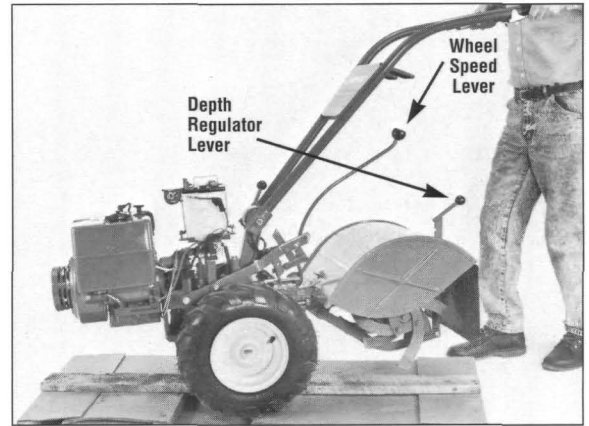

Photo 2-6. Move tiller off shipping platform. Move Wheel Speed Lever up or down to take wheels out of gear.

STEP 4: Connect Forward Interlock Wire Harness

A. Connect the plug on the wire harness that leads from the lower ends of the handlebars into the wire harness receptacle on the top, right side of the transmission (Photo 2-7). This connection completes the wiring circuit for the Forward Interlock Safety System. It must be connected or the engine will not start.

B. Before connecting the plug, be sure that it and the receptacle it's going into are clean.



WARNING

To avoid personal injury, test the Forward Interlock Safety System prior to each use of the tiller to be sure it is functioning properly. See Section 4 in this Manual for the testing procedure to use.

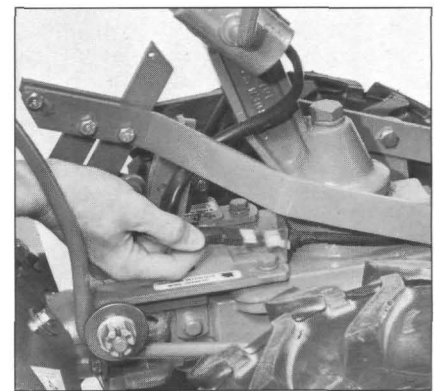

Photo 2-7. Connect forward interlock wire harness plug to receptacle.

STEP 5: Attach the Wheels/Tines/PTO Drive Lever

This control lever is shown in Photo 2-1. To attach it, you'll need the clutch pawl spring (see Photo 2-2).

Tools required: one 3/4" and two 1/2" wrenches.

A. Loosen the large bolt at the top of the handlebar base (Photo 2-8) with a 3/4" wrench. Don't remove it. Swing the handlebars out of the way to the right side of the tiller.



Photo 2-8. Loosen the large bolt securing the handlebar base. Swing handlebars to right side.

B. With two 1/2" wrenches, remove and save the nut, star washer, bushing and bolt from the hole at the rear of the clutch yoke assembly plates (see Fig. 2-9, items A, B, C, D).

C. Using two 1/2" wrenches, remove (and save) the nut, star washer and bolt (items E, F, and G, Figure 2-9) attaching the short vertical link to the center of the yoke. Keep the short link (with a bushing inside it) upright after the bolt comes out. If it swings down, reposition it upright again.

D. Slide the plates located at the end of the PTO drive lever over the yoke and align the upper hole in the plates with the hole at the rear of the yoke (refer to Photo 2-10). Insert the bushing (C, Figure 2-9) inside the yoke and install the bolt through the lever's plates, bushing and yoke. (Tap the bolt if necessary.) Add the star washer and nut and tighten the nut finger-tight.

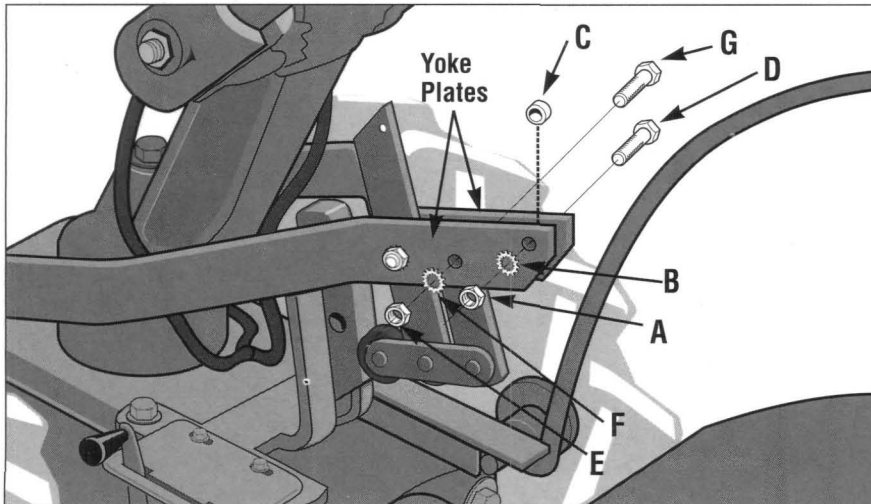

Figure 2-9. First remove hardware from rear of yoke plates (hardware items A, B, C, and D); then remove hardware securing short, upright steel link to yoke plates (hardware items E, F, and G).

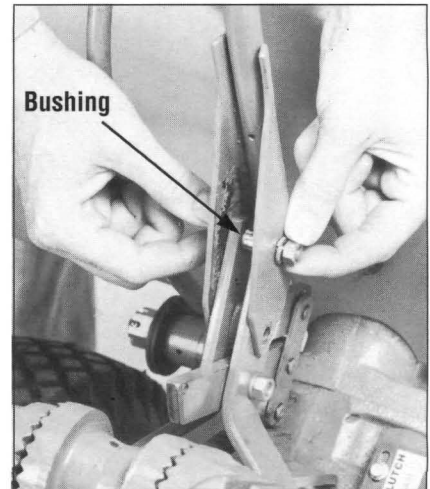

Photo 2-10. Insert bushing, then install bolt through upper hole in lever and yoke plates. Loosely add the star washer and the hex nut.

E. Look at both ends on the clutch pawl spring. One hook end has a wider opening. Insert the end with the wider opening fully into the small hole in the lever (hook pointing down). See A, Figure 2-11.

F. Tilt the lever fully up and insert the other end of the spring in the hole in the top of the long steel link (B, Figure 2-11). A pliers may help. Do not overstretch the spring. (Note: push handlebars to the right for extra clearance.)

G. Pull the lever back down. See Photo 2-12. Insert bolt removed earlier (per paragraph C) back in the remaining holes in the lever, yoke and short vertical link. Add star washer and nut.

H. Securely tighten both bolts.

I. Swing handlebars to the straight-ahead position and tighten the bolt in the handlebar base.

J. Test the operation of the lever. Push it down until it's engaged in the FORWARD position. See Photo 2-13 (the roller at the end of the shift linkage must be engaged beneath the belt adjustment block). Next, move the lever up to the NEUTRAL position— lift or tap it up and let it go. The roller should be resting on the face of the belt

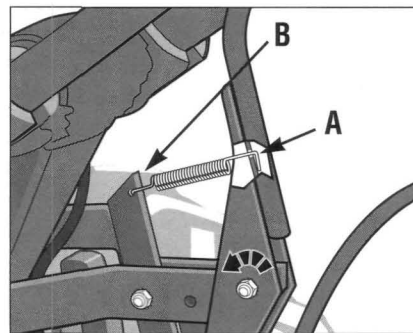

Figure 2-11. Install clutch pawl spring.

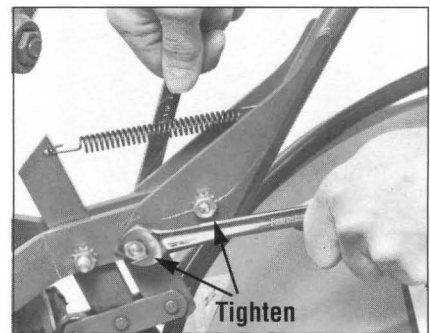

Photo 2-12. Pull lever back down. Reinstall last bolt, star washer and nut as shown above.

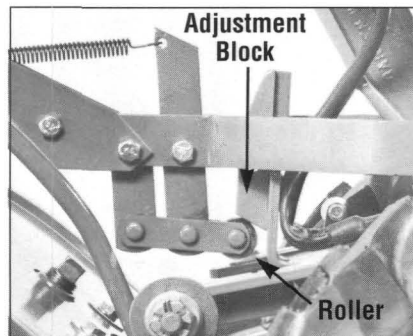

Photo 2-13. Push lever down into FORWARD position. The roller must go under the adjustment block.

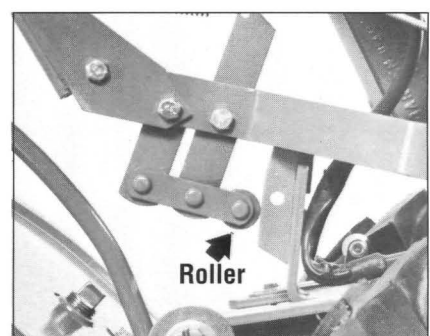

Photo 2-14. When lever is in NEUTRAL, roller rests against the face of the adjustment block.

adjustment block (Photo 2-14). Last, lift and hold the lever all the way up in REVERSE position— then let it go. It should automatically return to the NEUTRAL po-

sition. If not, do not use the tiller. See your local authorized Dealer or call our Technical Service Department for instructions.

Assembly

STEP 6: Check Gear Oil Levels in Power Unit Transmission and Tine Attachment Transmission

Your tiller has two separate transmissions: one for the Power Unit; the other for the Tine Attachment. Both were filled with SAE #85W-140 weight gear oil (with an A.P.I rating of GL-4) at the Factory. Please check level in *both* transmissions to verify that levels are still correct.

To Check Power Unit Transmission:

- A. Put the tiller on level ground.
- B. Pull Depth Regulator Lever back and then up so tines are resting on the ground (Photo 2-15).
- C. Use a 3/8" wrench to remove oil level check plug on left side of the transmission (just above the wheel shaft). See Photo 2-16. You may need to break the grip of any dried paint on the check plug.
- D. Oil should seep out hole if level is correct (in cold weather, it will seep out slowly). Reinstall plug securely if gear oil level is correct.
- E. If no oil seeped out, see if tilting tiller slightly toward check hole (roll right wheel on a 1" thick board) causes oil to seep out. If oil starts to seep, only a small amount should be added. But – if there is still no oil seeping out, the oil level may be seriously low. In either case, add the correct amount of gear oil before using the tiller —

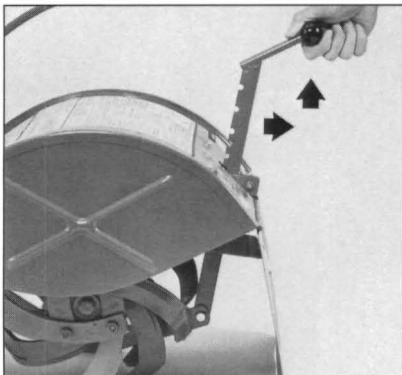

Photo 2-15: Pull Depth Regulator Lever back and then up to lower the tines to the ground.

see “Adding or Changing Gear Oil” in Section 5 of this Manual.

To Check Tine Attachment Transmission:

Two different gear oil level checking procedures for the tine attachment transmission follow. Use the procedure described first for Tine Attachment dipsticks with a ‘Check Cold’ marking. Use the second procedure if dipstick has both ‘cold’ and ‘hot’ markings at end. **First remove dipstick from tine transmission (Photo 2-17) to see which type dipstick you have. Then replace dipstick.**

For Dipsticks With ‘Check Cold’ Marking:

- A. Put the tiller on level ground.
- B. Pull Depth Regulator Lever back, then push it down all the way to engage its top notch. This raises tines off ground and lets tiller rest on drag bar.
- C. Place a support under engine to prevent tiller from tilting too far. Now slide three pieces of 2" x 4" lumber under drag bar – raising drag bar about 4-1/2" above ground. This elevation is needed to take an accurate “cold” gear oil reading (“cold” means tiller was never operated, or 2 hours have passed since it was used last).

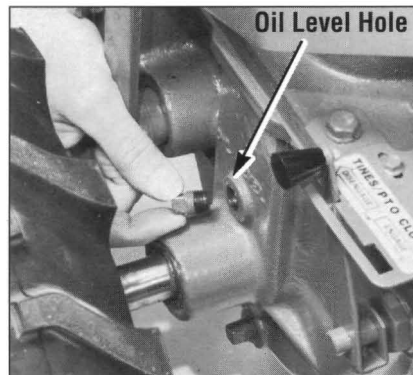

Photo 2-16: Gear oil should seep out from oil level check hole in power unit transmission.

D. Wait two hours with tiller elevated (allow more time if temperature is below 40°F).

- E. Loosen and remove transmission dipstick. (Photo 2-17). Wipe with a clean rag.
- F. Holding dipstick so markings face rear of tiller, lower it straight down into sump hole until it touches driveshaft inside (Photo 2-17). Don't force or try to thread it back in – or reading won't be correct.

G. Remove dipstick and check oil level. It should be within cross-hatched area or even slightly above the ‘Max’ marking. If correct, replace dipstick and remove boards.

H. If no oil showed on dipstick, correct amount of oil must be added to tine transmission. For complete instructions, see “Adding or Changing Gear Oil” in Section 5 of this Manual.

For Dipsticks With Hot/Cold Markings:

- A. Follow Steps A and B given for other type of dipstick.
- B. Put one 2"x4" board under drag bar – raising tiller and drag bar about 3-1/2" above ground. This elevation is for a ‘cold’ gear oil reading (tiller never used or 2 hours since used last).
- C. Follow Steps D, E, and F given for other dipstick type.

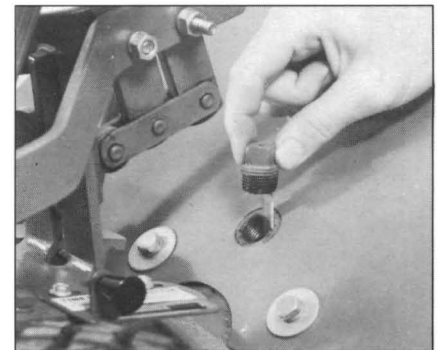

Photo 2-17: Remove dipstick to check gear oil in tine attachment transmission. Insert dipstick so markings face rear of tiller.

D. Remove dipstick and check that gear oil level is within or above 'Cold' range marking (use of 'Hot' marking is explained in Section 5). If correct, replace dipstick and remove the board.

E. If the level is incorrect, see "Adding or Changing Gear Oil" in Section 5 of this Manual.

IMPORTANT

Recheck gear oil level in both transmissions after the first two hours of new tiller operation, then every 30 operating hours thereafter. See Section 5 for instructions.

STEP 7: Add Motor Oil to Engine

Add high-quality API-rated "SF" or "SG" motor oil to engine before starting. Refer to the Engine Owner Manual provided with your unit for motor oil specifications and capacities.

To Add Oil:

A. Park the tiller on level ground. Place a sturdy block under the drag bar at the rear of the tiller to level the base of the engine.

B. An oil fill tube is located on each side of the engine. Either can be used. See Photo 2-18.

C. Clean around the oil fill tube and remove the oil fill plug. Use a clean funnel and slowly pour motor oil into the tube until the oil reaches the top of the fill hole.

D. Reinstall the oil fill plug and remove the block under the drag bar.

IMPORTANT:

- Always maintain oil level at the overflow point in the oil fill tube.
- Check engine oil level every 5 hours of operation or daily.
- Change engine oil after first 5 hours of new operation.



Photo 2-18: Add oil until it reaches top of oil fill tube.

STEP 8: Attach Engine Throttle Lever to Right Handlebar

The throttle cable (with throttle lever) is wound around the engine for shipping purposes. Carefully unwind the cable. If the throttle control decal is covered with a protective coating, peel it off. Attach the lever as follows.

A. You will need the curved head bolt, flange locknut, panhead screw and two plastic ties which are shown in Photo 2-2, Page 10.

B. Run the throttle cable up the inside edge of the right handlebar and position the lever as shown in Photo 2-19.

C. From the outside of the handlebar, insert the curved head bolt through the handlebar and the center hole in the throttle lever mounting bracket.

D. Loosely install the locknut.

E. Move the throttle lever to the STOP position.

F. From the lever side of the bracket, thread the panhead screw into the small hole in the throttle lever bracket and into the handlebar. See Photo 2-19. Tighten the screw securely.

G. Use a 7/16" wrench to securely tighten the locknut and the curved head bolt.

F. Using two plastic ties, secure the throttle cable to the right handlebar in two places, as shown in Photo 2-20. Loop each tie around the handlebar and cable (serrated side faces in) and pull the ties tight. Trim the ends.

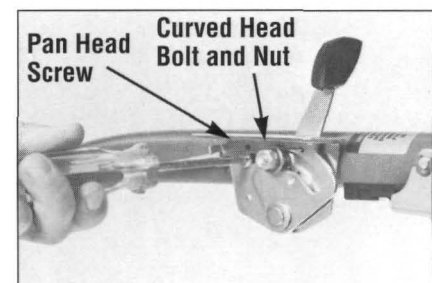

Photo 2-19: Attach engine throttle lever to handlebar.

Assembly

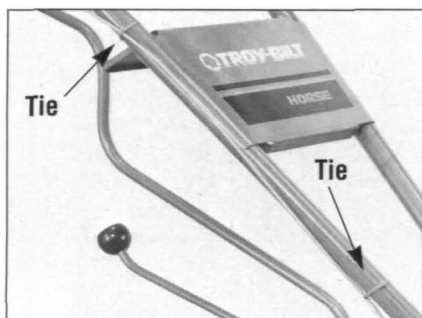

Photo 2-20: Use plastic ties in two places to hold cable to handlebars.



WARNING

On electric start tillers, to avoid electric shock from a short circuit, never allow throttle cable to touch the battery. Route cable below the battery, on the outside of the battery holder.

STEP 9: Adjust the Air Pressure in the Tires

A. For shipping purposes only, the tires are overinflated.

B. Before using the tiller, check the air pressure and adjust it to between 10-to-20 psi (pounds per square inch). Each tire should be inflated to the same pressure.

IMPORTANT

If you have a recoil start tiller, it is now completely assembled. If you have an electric start tiller, please continue with the few remaining steps.

ASSEMBLING THE ELECTRIC START SYSTEM

The following steps explain battery activation, battery charging and installation. For your safety, follow all steps and observe all accompanying safety messages. Section 5 has further general battery maintenance and recharging instructions you will find helpful.

STEP 1: Activating and Charging the Battery

IMPORTANT

The battery was shipped “dry.” It needs battery electrolyte fluid (battery-grade sulfuric acid) added to it. It must then be fully charged with a battery charger before being used.

Adding electrolyte fluid to the battery and battery charging can be dangerous work. The electrolyte contains acid that can burn or blind you. Battery charging also produces explosive gases.

To ensure that the battery is properly activated and charged, you should review these instructions with your battery technician.

It is strongly recommended that you have the battery activated and charged by a trained professional (Troy-Bilt Dealer, service station, farm equipment dealer, etc.) if you are not experienced with these procedures.



DANGER

Battery produces explosive gases.

- Keep sparks, flames, and cigarettes away.
- Ventilate area when charging or using battery in an enclosed space.
- Make sure venting path of battery is always open once battery is filled with acid.



DANGER

Battery electrolyte fluid is poisonous and burns severely.

Electrolyte is a sulfuric acid solution. Avoid spills or contact with skin, eyes, clothing.

• To prevent accidents, wear protective clothes, rubber gloves and shield eyes with safety goggles when working on or near the battery.

• Neutralize acid spills with a baking soda and water solution. Neutralize electrolyte container with same solution. Then rinse with clear water. **Antidote:** External— Flush with water; Eyes— Flush with water for 15 minutes and get immediate medical attention.

Antidote: Internal— Drink large quantity of water or milk. Follow with milk of magnesia, beaten eggs, or vegetable oil. Call a doctor immediately.

To Activate the Battery:



WARNING

Remove metal jewelry before working near the battery or near the electrical system. Failure to comply may cause a short circuit, resulting in electrical burns, a shock, or explosion of battery gases.

For shipping purposes *only*, the unserviced battery and its hold-down clamp were installed *backwards* at the factory. When reinstalling the battery and hold-down clamp, be sure to turn them around so they face in the opposite direction from which they were shipped.

A. Use a 7/16" wrench to remove the two 1-1/2" long bolts and the two 1/4" whiz nuts securing the front and rear hold-down clamp legs to the battery bracket (Photo 2-23). Lift off the clamp. Remove battery. Save the hardware.

B. If there is a short piece of sealed plastic tubing covering the vent fitting on the negative side of the battery (see Photo 2-23), remove and discard it.

C. Put the battery on a level work surface, far away from heat- or flame-producing sources like stoves, water heaters, dryers, furnaces, etc.

D. Take off the six filler caps on top of the battery. Put them aside. Refer to Photo 2-24.

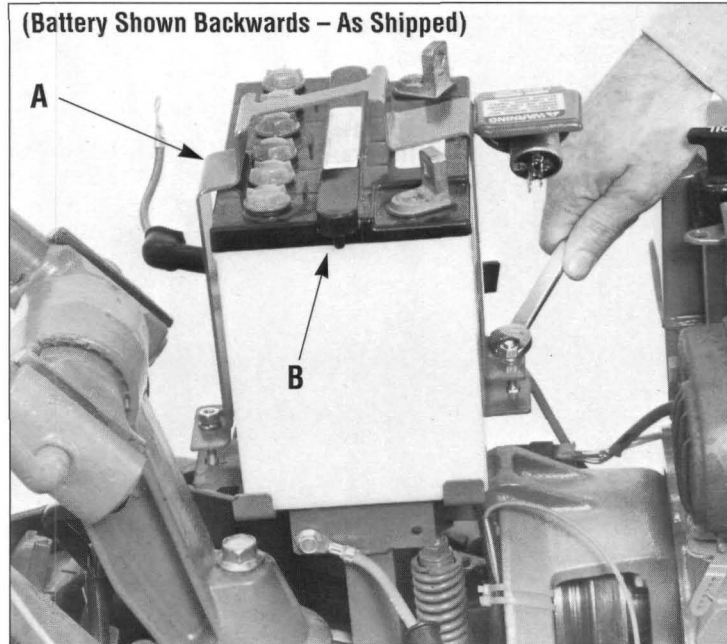

Photo 2-23: Remove hold-down clamp (A).

Remove the piece of clear plastic tubing (B) if so supplied.

E. *Be sure you are wearing protective clothes, rubber gloves and eye protection.* Fill each cell to the "Upper Level" line printed on the battery case using battery-grade electrolyte solution. (This is 1.265 specific gravity sulfuric acid.) Temperature of battery and electrolyte is ideal when between 60°F-to-80°F. Do not add water or any other liquid to the battery during this initial activation.

F. Let battery stand for 30 minutes. Check electrolyte level in each cell. Add more electrolyte solution if needed. *Don't overfill battery—this could lead to flooding from the cells during charging.*

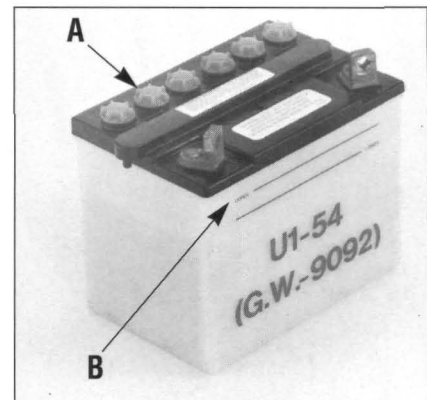

Photo 2-24: Remove all six filler caps (A). Fill each cell up to the "Upper" level line (B).

To Charge the Battery:

A. Follow one of the three charging methods described next for maximum starting capacity and longest battery life.

Note: The electrolyte solution within the cells is gassing freely when the surface of the electrolyte is covered with small bubbles. When checking for bubbles, always wear safety goggles to protect eyes. A flashlight makes the inspection easier. Inspect all cells.

Our Recommended Method:

Charge the battery at a rate of 1-to-2 amperes until all cells gas freely. Do not exceed 24 hours charging.

First Alternative Charging Method:

Charge the battery at a rate of 4-to-6 amperes until all cells gas freely. Do not exceed 8 hours charging.

Assembly

Second Alternative Charging Method:

Charge the battery at a rate from 6-to-12 amperes until all cells gas freely. Do not exceed 4 hours charging time.

B. Turn off the charging equipment and disconnect the charger cables from the battery terminals.

C. Recheck electrolyte level in each cell. Top off any low cells with electrolyte solution up to the "Upper" level line.

D. Securely replace all six filler caps. Use a baking soda and water mixture to rinse off electrolyte that may have spilled on the battery.



DANGER

Never jump start the battery with a vehicle battery or charging system. This may produce a battery explosion, causing acid or electrical burns.



DANGER

To Avoid Personal Injury or Property Damage:

- Batteries produce explosive gases – always keep sparks and flame away from battery.
- Ventilate area when charging or using the battery.
- During charging, don't leave battery unattended. Charging time need not be continuous.
- Follow safety rules and instructions supplied by battery and charger manufacturers.
- Do not charge battery at a rate higher than 12 amperes to avoid generating excessive heat and gassing which could damage the battery.



DANGER

To Avoid Personal Injury or Property Damage:

- Do not touch positive battery terminal and any surrounding metal objects with tools, jewelry or other metal items. Failure to comply could cause a short circuit leading to electrical burns or explosion of battery gases.
- Never bring a gas can near the positive (+) battery terminal. A short circuit could occur leading to an explosion of the gasoline or the battery gases. Always fill the engine fuel tank from the front or side of the engine.

STEP 2: Connect the Wire Harness Receptacle

A. The keyswitch (A, Figure 2-25) is part of the hold-down clamp assembly (D). The prongs at the

back of the keyswitch must be securely inserted into the plastic wire harness receptacle (B).

B. Remove the pair of ignition keys from the keyswitch. Store

them safely away. Do not put a key in the keyswitch until you have read the sections in this Owner/Operator Manual covering features, controls and operation.

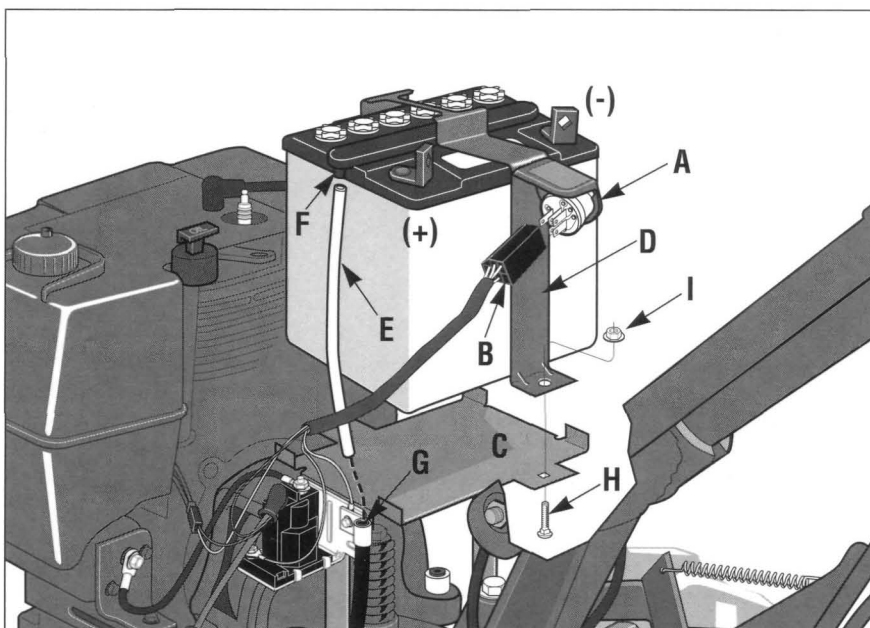

Figure 2-25: First connect Keyswitch (A) to wire harness (B). Then, the activated battery must be secured to mounting platform (C) using the hold-down clamp (D) with its mounting hardware (H, I). Last, install plastic vent tube (E) over the vent fitting (F), and down into vent tube shield (G).

STEP 3: Installing the Battery

A. Carefully place the activated battery back on the battery mounting platform as seen in Fig. 2-25. *The side of the battery with the terminals (the posts) and the fill lines on it must face the rear of the tiller.* [Another way to verify the correct placement of the battery is when the positive (+) battery post is on the left side of the tiller as you face forward when standing behind the handlebars.]



CAUTION

Incorrect installation of the battery can result in electrical system damage.

Follow these installation instructions carefully to avoid damage to your tiller.

B. Place the battery hold-down clamp (D, Figure 2-25) over the battery, and secure the two legs of the clamp to the platform (C) using the two bolts and whiz nuts (H, I) removed previously. Insert the bolts up from the bottom. Tighten the hardware to make the battery secure, but don't overtighten the nuts or the clamp tabs will bend.

C. The clear plastic vent tubing must be installed next. If coiled up, straighten it out. Slide one end of the tube (E, Figure 2-25) over the vent fitting (F) at the top of the battery. Slide the other end down into the black vent tube shield (G).



WARNING

Improper battery venting can cause a battery to explode, resulting in severe personal injury.

Be sure the vent tube is not crimped, pinched or folded.

STEP 4: Installing the Battery Cables

A. Locate the two (2) 5/8" long bolts and 1/4"-20 hex nuts shown in Photo 2-3 on page 10. Use them to connect the loose ends of the two battery cables to the two battery terminals (posts).

B. On the left side of the tiller (as viewed from behind the handlebars), connect the loose end of the positive (+) battery cable (A, Figure 2-26 – this is the red cable already attached at the other end to the solenoid) to the positive (+) battery post (B). Hold the cable terminal against the side of the post facing the keyswitch. Install and tighten a bolt (E) and nut (F) with two wrenches.

C. Slide the pre-installed black rubber boot (G) completely over the battery post and hardware.

D. Repeat this procedure on the right side of the battery. Position the end of the negative cable (C) against the negative battery post (D) as shown, and secure it with the remaining bolt (E) and nut (F). Again, slide the black rubber boot completely over the battery post.

E. Check the lower end of the vent tube shield into which you inserted the clear plastic vent tube. The lower end of the black shield must be located in front of the wheel shaft axle. Move it there if necessary. Your electric start tiller is now fully assembled.

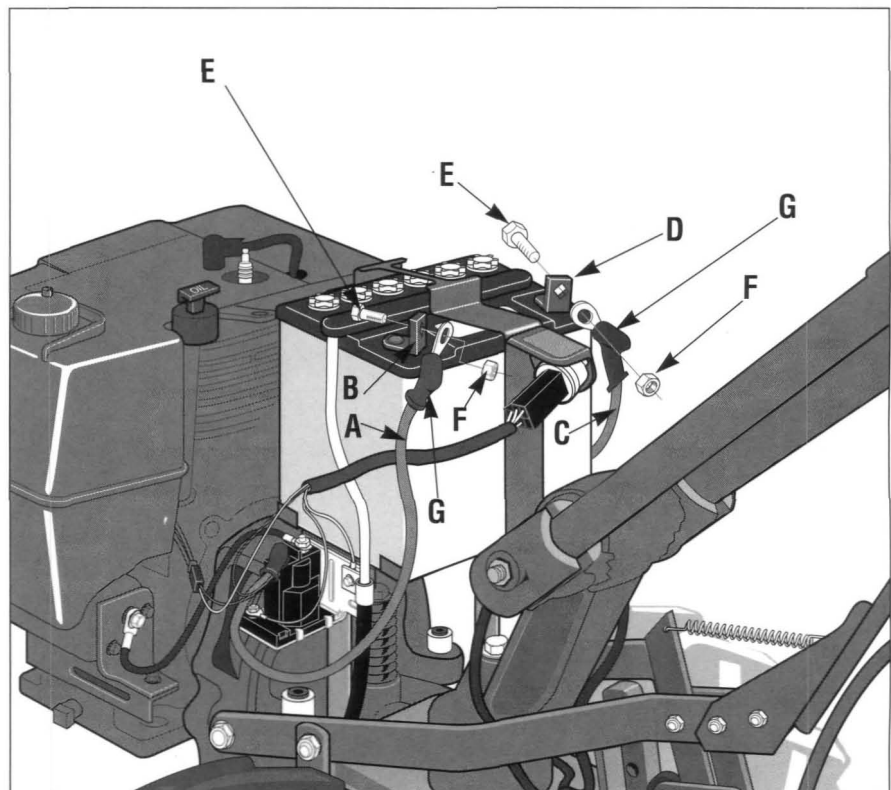

Figure 2-26: Connect positive (+) cable (A) to positive battery post (B). Connect negative (-) cable (C) to negative battery post (D). Be sure to position bolts (E) and nuts (F) as shown. After the connections are secure, slide black rubber boots (G) completely over battery posts.

Section

3

Features and Controls



Learn the locations of the features and controls on your machine before starting the engine. Taking the time now to understand the location, function and operation of these controls will greatly add to the productive use, safe operation, and enjoyment of your machine. For detailed step-by-step operating instructions, please refer to "Section 4: Operation."



WARNING

TO AVOID PERSONAL INJURY OR DAMAGE TO EQUIPMENT:

Before using your tiller or PTO Power Unit for the first time, become thoroughly familiar with the operation of the controls by moving them to their various positions while the engine is not running. The proper operation of each control is discussed in detail in Section 4.

NOTE: All references to left, right, front and rear of the machine are determined by standing behind the handlebars and facing the direction of forward travel.

TILLER FEATURES AND CONTROLS IDENTIFICATION

The major tiller controls and features are identified and illustrated on the next few pages. The use and operation of each control and feature is covered in detail in Section 4 "Operating Instructions."

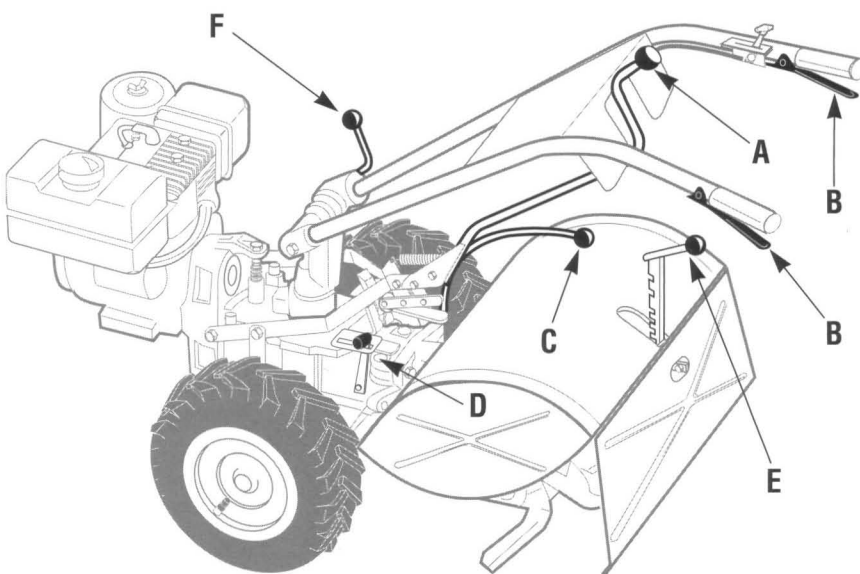

Figure 3-1: A– Wheels/Tines/PTO Drive Lever; B– Forward Interlock Levers; C– Wheel Speed Lever; D– Tines/PTO Clutch Lever; E– Depth Regulator Lever; F– Handlebar Height Adjustment Lever.

Wheels/Tines/PTO Drive Lever

This lever (A, Figure 3-1) engages and disengages power from the engine to the transmission. It has three operating positions: FORWARD, NEUTRAL and REVERSE.

FORWARD – Lever moved down until it engages in drive position (clutch roller at end of lever is engaged below adjustment block, as shown in Photo 3-1A). Use this setting for forward motion of the wheels and tines, or to apply power to any optional PTO (Power Take Off) attachment.

To stop the wheels, tines or any PTO attachment, move the lever to NEUTRAL by lifting or tapping the lever upwards and letting it go (in NEUTRAL the clutch roller will be located on the face of the adjustment block, as shown in Photo 3-1B).

REVERSE – Lever moved all the way up and held in that position (clutch roller will be located higher on the face of the adjustment block, as shown in Photo 3-1C). Use this setting for moving the machine in reverse. To stop moving in reverse, let go of the lever and it will automatically return to the NEUTRAL position.

Check Position of Clutch Roller

As you shift between FORWARD, NEUTRAL and REVERSE, the clutch roller at the bottom of the lever should be positioned as shown in Photos 3-1A, 3-1B and 3-1C. Check the position of the clutch roller as you shift the lever. If it is not positioned correctly, contact the factory or see your local authorized dealer.

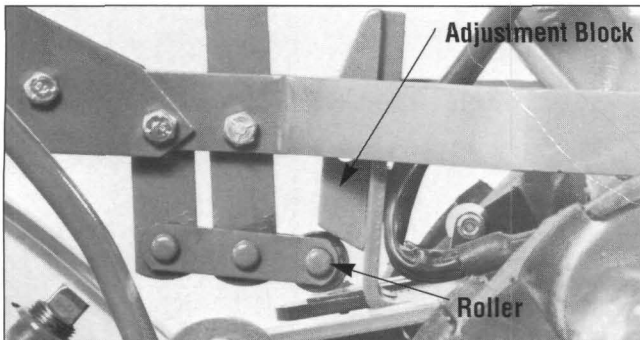

Photo 3-1A: When the Wheels/Tines/PTO Drive Lever is in the FORWARD position, the clutch roller will be engaged below the adjustment block.

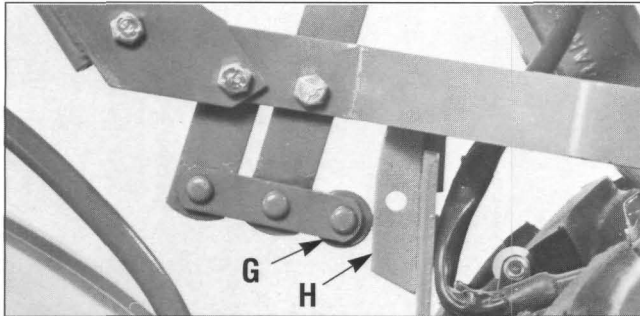

Photo 3-1B: When the Wheels/Tines/PTO Drive Lever is in the NEUTRAL position, the clutch roller (G) must be located approximately as shown on the face of the adjustment block (H).

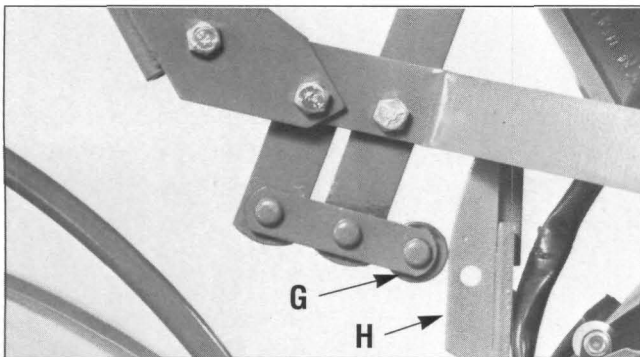

Photo 3-1C: When the Wheels/Tines/PTO Drive Lever is held up in the REVERSE position, the clutch roller (G) must be located higher on the face of the adjustment block (H).

- Do not operate the tines or any PTO attachment when in REVERSE.

NEUTRAL – Lever moved in between FORWARD and REVERSE positions. Use this setting to stop the wheels, tines or any PTO attachment.

- Always shift to NEUTRAL before starting the engine or before engaging the wheels, tines or any PTO attachment.

Forward Interlock Levers

A Forward Interlock Lever (B, Figure 3-1) is located below each handlebar grip.

At least one of these interlock levers must be kept squeezed against a handlebar grip whenever the Wheels/Tines/PTO Drive Lever is engaged in FORWARD. (The levers do not affect operation when the Wheels/Tines/PTO Drive Lever is in REVERSE.)

If both interlock levers are released before first returning the Wheels/Tines/PTO Drive Lever to NEUTRAL, the engine will stop.

IMPORTANT – This is a safety feature should you lose control of your tiller and cannot stop forward motion by moving the Wheels/Tines/PTO Drive Lever into NEUTRAL.

Wheel Speed Lever

Use this lever (C, Fig. 3-1) to select a wheel speed or the freewheel position. There are three operating positions: SLOW, FAST and FREEWHEEL.

SLOW – Lever moved all the way down. Use for normal tilling or for low-speed transporting.

FAST – Lever moved all the way up. Use for cultivating or for fast-speed transporting.

FREEWHEEL – Lever in between SLOW and FAST positions (wheels will roll freely). Use for transporting the machine on level ground without engine power and when using stationary PTO attachments.

- To avoid transmission damage, always put the Wheels/Tines/PTO Drive Lever in NEUTRAL before shifting the Wheel Speed Lever.
- When shifting into SLOW or FAST, gently roll the machine to help fully engage the wheel gears. When engaged, the wheels will not turn unless the engine is running and the Wheels/Tines/PTO Drive Lever is engaged in FORWARD or REVERSE.

Features and Controls

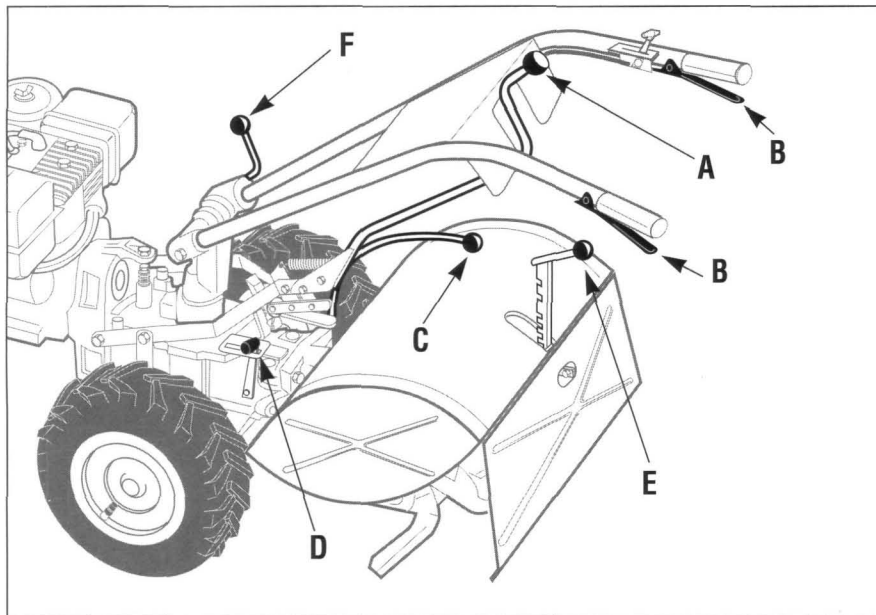

Figure 3-2: A– Wheels/Tines/PTO Drive Lever; B– Forward Interlock Levers; C– Wheel Speed Lever; D– Tines/PTO Clutch Lever; E– Depth Regulator Lever; F– Handlebar Height Adjustment Lever.

Tines/PTO Clutch Lever

Use this lever (D, Figure 3-2) to engage or disengage power from the transmission PTO clutch to the tines or any PTO attachment. It has two operating positions: ENGAGE and DISENGAGE.

ENGAGE – Lever moved into detent slot furthest from engine. Use to operate tines or other PTO attachments. After shifting to ENGAGE, briefly operate machine in FORWARD to help fully engage the PTO clutch.

DISENGAGE – Lever moved into detent slot nearest engine. Use to disengage power to tines or other PTO attachments before transporting, loading, turning, or backing up.

- To avoid transmission damage, always put the Wheels/Tines/PTO Drive Lever in NEUTRAL before shifting the Tines/PTO Clutch Lever.

Depth Regulator Lever

Use this lever (E, Figure 3-2) to regulate the tilling depth of the tines. It also has a TRAVEL position, which places the tines out of the ground.

To operate the lever, pull it straight back and then slide it up or down to any of the eight notched settings.

The highest notch is the TRAVEL setting. For shallow tilling and cultivating, use the second or third notch from the top. The other notches are for deeper tilling and for power composting.



WARNING

To avoid personal injury, always place the tines in the TRAVEL position before starting the engine. This prevents the tines from touching the ground until you are ready to begin tilling.

Handlebar Height Adjustment Lever

Use this lever (F, Figure 3-2) to adjust the handlebars at one of the two preset height settings.

To change the height, hold the handlebars with one hand and loosen the lever in a counterclockwise direction. Move the handlebars to one of the two preset height settings and retighten the lever.

- Swapping the positions of the inside handlebar ratchets (see Page 11) will change the preset settings by a few inches.



WARNING

For use with the PTO Chipper/Shredder attachment only, the handlebars can be swung 30° to the right side by loosening the mounting bolt at the bottom of the handlebar base. Never operate your tiller or other attachments with the handlebars swung out to the right side. This could result in unsafe handling and personal injury.

ENGINE FEATURES AND CONTROLS IDENTIFICATION

The following are descriptions of the controls on your engine.

Additional engine information is provided in Section 4 “Operation” and in the engine manufacturer’s Owner’s Manual which was included in your literature package. Be sure to read the engine Owner’s Manual carefully and save it for future reference.



WARNING

To avoid serious personal injury or damage to equipment, do not start your engine at this time. Complete starting instructions are described in

Section 4 “Operation.”

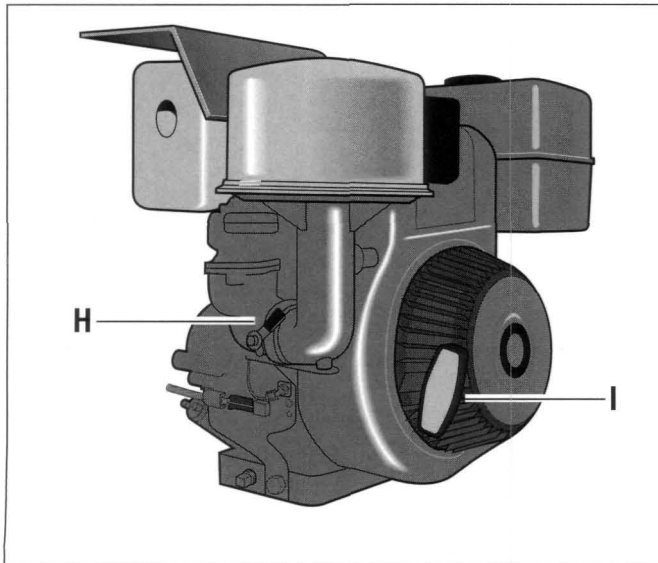

Figure 3-4: 7HP Briggs & Stratton engine. H- Choke control, I- Recoil starter.

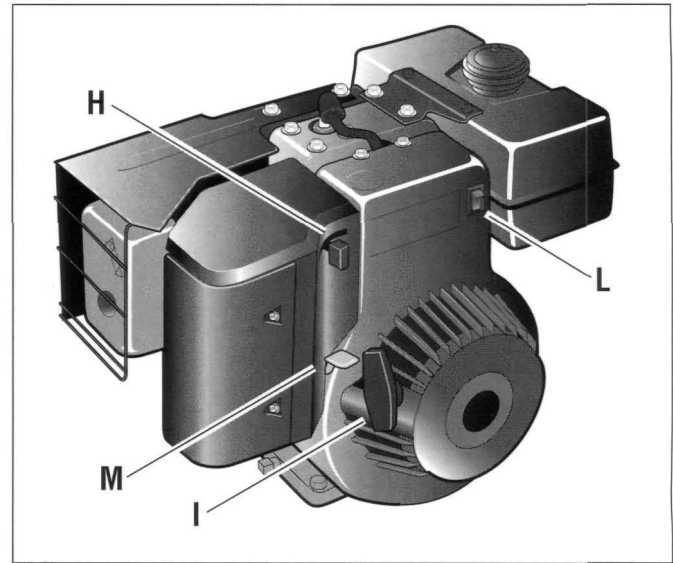

Figure 3-5: 8HP IP Briggs & Stratton engine. H- Choke control; I- Recoil starter; L- ON/OFF Switch; M- Secondary engine throttle control lever.

Engine Throttle Lever

The throttle lever on the right handlebar (G, Figure 3-3) is used to adjust the engine speed as well as start and stop the engine (a secondary throttle lever

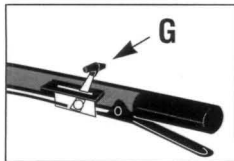

Figure 3-3

is located on the front of the 8HP IP engine -- see M, Figure 3-5.)

Move the lever away from the STOP position before starting the engine. Engine speeds can be varied between the FAST and SLOW settings. Use the STOP position to turn the engine off.

Engine Choke Control

The choke control lever (H, Figures 3-4 or 3-5) makes starting a cold engine easier. The choke increases or decreases the amount of air in the carburetor's fuel-air mixture. Use the CHOKE position when starting a cold engine. After starting, gradually return the lever to the RUN position.

Engine Recoil Starter

The recoil starter (I, Figures 3-4 or 3-5) is used to manually start the engine. Before pulling the starter rope, the Wheels/Tines/PTO Drive Lever must be in NEUTRAL and your free hand must be on top of the fuel tank to stabilize the tiller.

Keyswitch Starter

The keyswitch starter on electric start models (J, Figure 3-6) has three positions: OFF, RUN and START. Turn the key to START to start the engine. Release the key and it will return to the RUN position. Turn the key to OFF to stop the engine. (A second way to stop the engine is to move the engine throttle lever to the STOP position.)

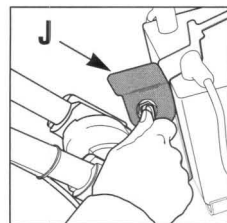

Figure 3-6

Fuel Shut-Off Valve

The shut-off valve (K, Fig. 3-7) is located under the fuel tank. The valve must be in the ON position (1/4 turn counterclockwise) to operate the engine. Close the shut-off valve when the tiller is transported or not in operation to prevent fuel leakage.

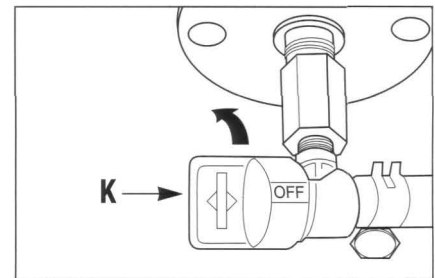

Figure 3-7

On/Off Switch

The 8 HP Briggs & Stratton IP engine has an On/Off Switch (L, Figure 3-8) which must be switched to ON before operating the engine.

Section

4 Operation



As with any other piece of outdoor powered equipment, getting the "feel" for how your machine operates and getting to know the best techniques for particular jobs are very important to overall good performance.

Read this Section very thoroughly before you start the engine. The instructions given here will help you familiarize yourself with the tiller and have you operating it efficiently in a short time.

WARNING

Before operating your machine, be sure you read and understand all safety, controls, and all operating instructions in this Owner/Operator Manual and on the decals on your machine.

Failure to follow these instructions can result in serious injury or property damage.

NOTE: All references to left, right, front and rear of the machine are determined by standing behind the handlebars and facing the direction of forward travel.

This Section explains how to:

- Perform Pre-Starting Break-In and Preparation
- Test the Forward Interlock Safety System
- Start and Stop the Engine
- Operate and Turn the Tiller Around
- Transport the Tiller
- Change Belt Range Speed (from High to Low and back)
- Till in the Garden
- Till Up and Down Slopes
- Use Special Tilling Techniques
- Remove and Replace the Tine Attachment
- Use the PTO Power Unit with Other Attachments



Photo 4-1

Before operating the tiller, be sure you have first read and understood all Safety Instructions in Section 1 and Controls information in Section 3. First practice using the tiller in an open, level area. Practice without the tines revolving – disengage the tines with the Tines/PTO Clutch Lever. After a thorough practice session, the tiller can then be moved to the garden.



WARNING

Your tiller and its optional PTO attachments are capable of causing serious injury to untrained or careless operators.

To avoid serious personal injury or property damage, read the Owner/Operator Manual provided with any optional accessories or attachments before using the tiller or PTO power unit.

Break-In Operation

During the first few hours of new tiller operation, the following maintenance steps are required. For subsequent maintenance procedures, refer to Section 5 — Maintenance.

1. Change Engine Oil. Change the oil after the first 5 hours of new operation. Thereafter, change oil after every 10 operating hours. Increase the frequency of oil changes under very dirty or dusty conditions.

2. Check Transmission Gear Oil Level. After the first 2 hours of new operation, check the gear oil levels in the PTO power unit and the tine attachment transmissions. Thereafter, check them every 30 hours.

3. Check Drive Belt Tension. Due to belt seating, a tension adjustment may be needed after the first 2-to-3 hours of new operation. Thereafter, check belt tension every 10 operating hours.

4. Check Hardware. After 2 hours of new operation, check for loose bolts and nuts. Thereafter, do this every 10 operating hours.

Preparation Before Starting

Make the following checks and perform the following services *before* starting the engine.

- 1. Check Engine Oil Level.**
- 2. Check the Air Cleaner.** It must be securely assembled and clean.
- 3. Check Safety Guards.** All guards and covers must be securely in place.
- 4. Attach Spark Plug Wire.**
- 5. Check Engine Cooling System.** The cooling fins and air intake screen must be clear of debris.
- 6. Adjust Handlebar Height.**
- 7. Check Battery Fluid Level.** Cells must be filled to proper level, cell caps must be tight, and all electric wire connections secure.
- 8. Add Gasoline to Fuel Tank.** Use fresh, clean, lead-free automotive gasoline. A minimum of 77 octane is recommended. **DO NOT MIX OIL WITH GASOLINE!**

Refer to the separate Engine Owner's Manual for detailed fuel recommendations.

Note: The use of gasoline which contains alcohol, such as gasohol, is not recommended. However, if gasoline with alcohol is used, it must contain less than 10% Ethanol and must be removed from the engine during storage. Do not use gasoline which contains Methanol.

Purchase fuel in a quantity that can be used within 30 days. This will assure fuel freshness and volatility tailored to the season. The use of a fuel stabilizer additive will prevent gum from forming in the fuel system or on essential carburetor parts. See the "Storage Instructions" in the Engine Owner's Manual.

To Add Gasoline:

- Clean the fuel cap area before removing the fuel cap.
- Using a clean funnel, fill tank to within 1/2" of the top to prevent spills and to allow for fuel expansion. Replace the fuel cap securely before starting the engine.



DANGER

Gasoline is highly flammable and its vapors are explosive. Follow these safety practices to prevent injury from fire or explosion:

- Never fill tank if engine is running or hot from use. Let engine and muffler cool down before refueling.
- Do not permit open flames, sparks, matches or smoking in the fueling area.
- Fill fuel tank outdoors in a well-ventilated area. Wipe up any fuel spills and move tiller away from fumes before starting the engine.
- Use only an approved fuel container and lock it safely away from children.
- Store fuel and the tiller in a well-ventilated area. Do not store fuel or tiller where fuel vapors may reach an open flame or spark, or an ignition source (a hot water heater, furnace, clothes dryer, electric motor, or the like).
- Let engine cool before storing.
- Never bring a metal fuel can near battery post on electric start model tillers. An electrical short circuit could result, causing an explosion of the gasoline or of battery gases.

Operation

Test Operation of Forward Interlock Safety System

The Forward Interlock Safety System is designed to shut the tiller engine off immediately if you lose control of the tiller and cannot stop forward motion by moving the Wheels/Tines/PTO Drive Lever into NEUTRAL.

Simply, it is an electrical grounding system that connects the two Forward Interlock Levers on the handlebars to the engine's ignition system. Either one (or both) of the Forward Interlock Levers must be kept squeezed against the handlebar grip(s) whenever the Wheels/ Tines/ PTO Drive Lever is engaged in FORWARD.

If you release both the Forward Interlock Lever(s) before first moving the Wheels/Tines/PTO Drive Lever to NEUTRAL, the interlock system will ground out the engine's ignition system and stop the engine. (The interlock system also prevents the engine from starting if the Wheels/ Tines/PTO Drive Lever is engaged in FORWARD.)

This system has an electro-mechanical design, and so is subject to normal wear and possible malfunction. As such, it must be checked for proper operation before you use the tiller or PTO power unit each time.



DANGER

The Forward Interlock Safety System is designed for the operator's safety. Do not disconnect or attempt to defeat the purpose of the system. If the system malfunctions, immediately contact your local authorized dealer or the TROY-BILT Technical Service Department for assistance. Do not use the tiller or the PTO power unit until the Forward Interlock Safety System is functioning properly. Always test the system before using the tiller or PTO power unit.

How to Check the Interlock System:

1. Move tiller outside on level ground. Remove any obstacles.
2. Check that the Forward Interlock wire harness plug at the bottom of the handlebars is firmly connected to the receptacle on the top, right side of the transmission. See Photo 4-2.

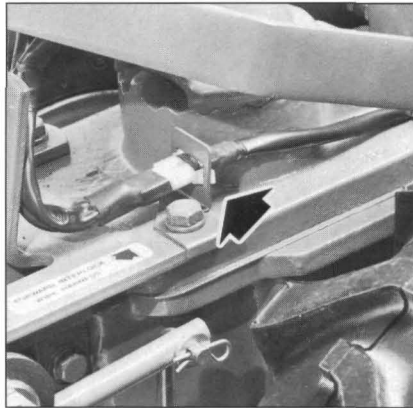

Photo 4-2: Plug and receptacle of Forward Interlock Safety System must be securely connected.

3. Move Wheel Speed Lever to SLOW position and move Tines/PTO Clutch Lever to DISENGAGE.
4. Start engine as described later in this section. Set engine throttle lever to SLOW, and let engine warm up.

5. Squeeze and hold just one of the Forward Interlock Levers against the handlebar grip while moving the Wheels/ Tines/ PTO Drive Lever down to FORWARD. (See Photo 4-3). As the tiller moves forward, release the Forward Interlock Lever briefly. The engine should start to stall out if the interlock system is working properly. If it does start to stall, quickly squeeze the lever up against the handlebar grip, and then return the Wheels/ Tines/ PTO Drive Lever to NEUTRAL. Repeat this test to check that the engine begins to stall out when the other Forward Interlock Lever is released.

6. If the engine does not begin to shut off when either Forward Interlock lever is released, shut the engine off, remove the key (if electric start), and do not operate the tiller or PTO power unit until the system has been repaired and is functioning properly.

IMPORTANT – To avoid possible damage to the Forward Interlock Safety system, do not use high-pressure sprays near the wire harness receptacle or neutral plunger assembly.

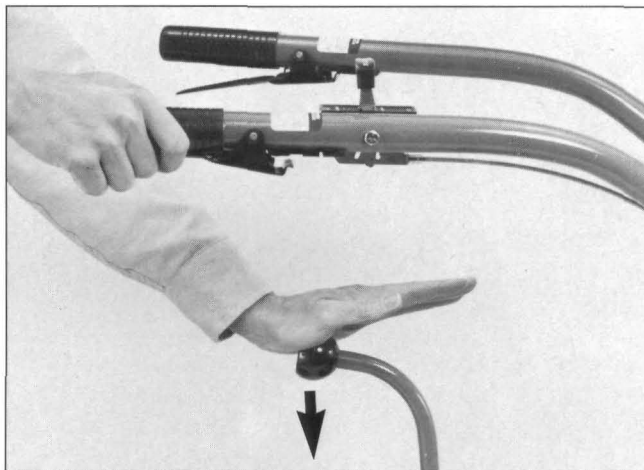

Photo 4-3: Squeeze one Forward Interlock Lever and then move Wheels/Tines/PTO Drive Lever down to FORWARD.

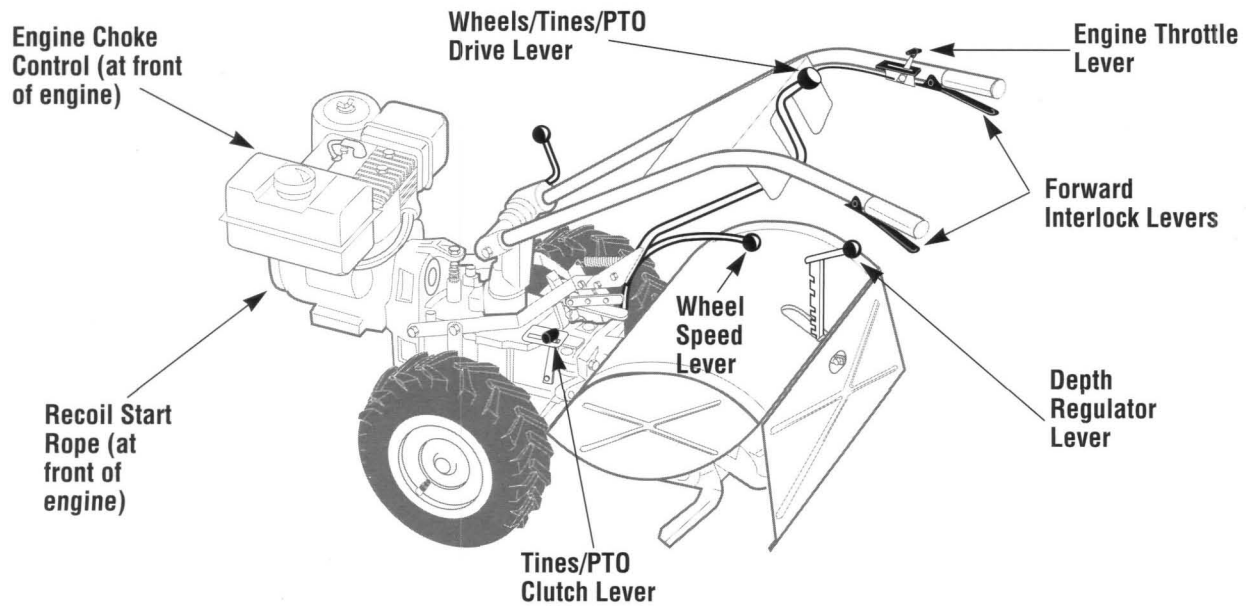

Figure 4-4: Tiller and engine controls.

Starting and Stopping the 7HP and 8HP IP Briggs & Stratton Engines

IMPORTANT– Use the following steps to practice starting and stopping the engine **ONLY**. Do not attempt to drive tiller or PTO Power Unit until you have read all operating instructions in this Owner/Operator Manual.

To Start the Engine:

1. With the engine off, place the Wheels/Tines/PTO Drive Lever in the NEUTRAL position (see Figure 4-4). If in the FORWARD position, tap or lift the lever up and then release it to obtain NEUTRAL.
2. Lower the Depth Regulator Lever (see Figure 4-4) until the tines are off the ground.
3. Move the Wheel Speed Lever (Figure 4-4) to either the SLOW or FAST position. *Be sure to roll the wheels while shifting the lever until the wheels are engaged.*
Note: If using a PTO stationary attachment, move lever to FREE-WHEEL and block the wheels to prevent the equipment from moving.

4. Put the Tines/PTO Clutch Lever in the DISENGAGE position (see Figure 4-4). (Use the ENGAGE position if you want the tines to revolve or to apply power to a PTO-driven stationary attachment.)

5. The fuel tank shutoff valve must be in the OPEN position (see Figure 3-7, Page 23).

6. Move the Engine Throttle Lever on the handlebars forward (away from the STOP position). On the 8HP IP engine, the Throttle Control Lever at the front of the engine will also move.

7. On the 8HP IP engine only, put the ON/OFF switch at the front of the engine in the ON position.

8. On the 7HP engine, move the Choke Control Lever down to the CHOKE position (see Fig. 4-5). On the 8HP IP engine, put the Choke Control Lever in the CHOKE position (see Fig. 4-6). **Note:** Use of the CHOKE position may not be necessary if the engine is still warm from recent operation.

9. For recoil start engines:

- a.) Stabilize the tiller by placing one hand on the fuel tank.

- b.) Check that area behind you is free of persons or obstacles. Use your other hand to slowly pull out the start rope until resistance is felt. Then rapidly pull the rope out to start the engine. Let it rewind slowly.

10. For electric start engines:

- a.) Turn key to START position. Do not hold key at START for more than a few seconds. Starter damage can occur if it is cranked more than 15 seconds per minute.
- b.) Release key when engine starts. It will move to RUN position automatically.

11. If engine does not start after several tries, repeat start attempts with the choke opened slightly.

12. After the engine starts, slowly move the Choke Control Lever to a halfway position, then to the RUN position (lever fully opposite the CHOKE position). DO NOT operate the engine with the lever in a partial CHOKE position as excessive speeds may occur.

13. Move the Throttle Lever to the SLOW position and allow the engine to warm up.

Operation

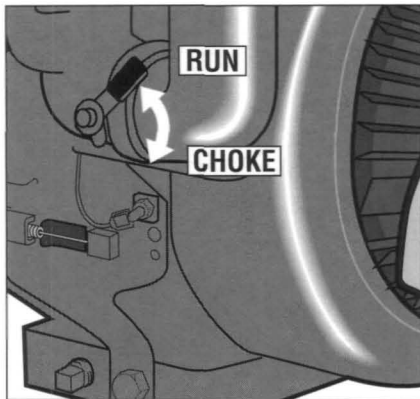

Figure 4-5: Choke Control Lever on the 7HP engine. Down for CHOKE; up for RUN.

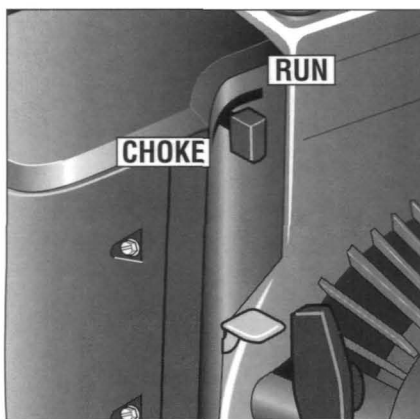

Figure 4-6: Choke Control Lever on the 8HP IP engine. Left for CHOKE; right for RUN.

To Stop the Engine:

1. To stop the wheels and tines, move the Wheels/Tines/PTO Drive Lever to the NEUTRAL position and then release both Forward Interlock Levers.

2. Move the engine Throttle Lever to the STOP position (and on electric start models turn the key to OFF). Remove the key for safekeeping.

Note: The 8HP IP engine has a Throttle Control Lever and an ON/OFF switch on the front of the engine. Either control can also be used to stop the engine. On electric start models, always remove the key for safekeeping.

IMPORTANT – If the engine does not stop after moving the engine controls to STOP or turning the keyswitch to OFF, then stop the engine by moving the Choke Control Lever to the CHOKE position. This will stall the engine. Use this procedure only in an emergency! Repair the engine control or keyswitch before reusing the tiller.

Starting the Electric Start Engine with the Recoil Starter Rope

If necessary, an electric start engine may be started with the recoil start rope. Before doing so, follow the procedure below applying to you.

1. If battery condition is OK (not “dead” or damaged), leave it connected on the tiller so it gets recharged during engine operation. Be sure battery cells are full and cables are connected before starting the engine.
2. If battery is “dead” or damaged, disconnect and remove it for testing by a qualified mechanic. Before starting engine, wrap metal terminal at end of positive cable with electrical tape and secure the cable to the battery bracket to prevent electrical sparking.
3. Before starting the engine with the recoil start rope, turn the keyswitch to the RUN position. The Throttle Lever must be in the START position and the choke lever in the CHOKE position.

Cold Weather Operation

Below 40°F, take the following steps to protect your engine and transmission from damage:

1. Refer to the Engine Owner Manual provided with your unit for motor oil specifications appropriate for cold weather operation.
2. Let engine warm up before putting it under a load.
3. Use winter-blend gasoline.
4. Use the correct weight gear oil in PTO Power Unit transmission.
5. Warm up the transmission gear oil as follows: with engine running, move Wheel Speed Lever (see Figure

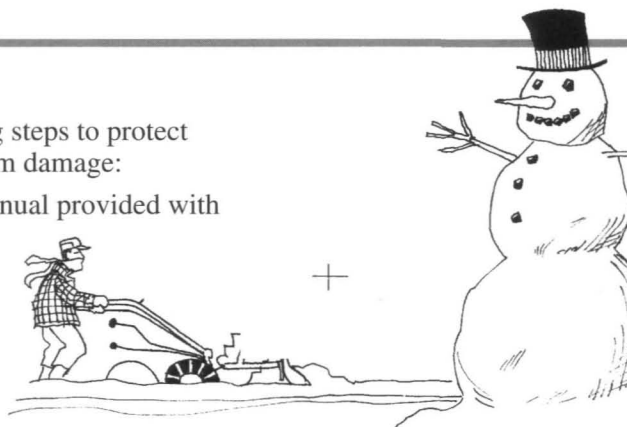

the ground, melt ice with warm water.

- 4-4) FREEWHEEL (then block wheels so they can't roll), put Tines/PTO Clutch Lever in DISENGAGE, then squeeze one of the Forward Interlock Levers and shift the Wheels/Tines/PTO Drive Lever to FORWARD.

6. If wheels are frozen to the ground, melt ice with warm water.

To Operate the Tiller



CAUTION

To avoid serious personal injury or damage to equipment:

- Always place Wheels/Tines/PTO Drive Lever in NEUTRAL before starting engine, and before engaging wheels, tines or other PTO-driven attachments.
- Be sure there are no obstacles behind you before reversing.
- Wheels/Tines/PTO Drive Lever should automatically return to NEUTRAL when released from REVERSE position. If it does not, move lever to NEUTRAL manually and see Section 5 to adjust it.
- No reverse motion should occur if Wheels/Tines/PTO Drive Lever is not held up in REVERSE. See Section 5 for adjustment steps. Do not use tiller unless properly adjusted.
- Always return to NEUTRAL and let all motion stop before shifting to FORWARD or REVERSE.

When first practicing, keep the Tines/PTO Clutch Lever in DIS-ENGAGE position and the Wheel Speed Lever in SLOW position.

To Begin Tilling:

1. Start the engine (see previous instructions). The Wheels/Tines/PTO Drive Lever must be in NEUTRAL before starting the engine. The Wheel Speed Lever must be in either SLOW or FAST position.
 2. Test the Forward Interlock Safety System. See page 26.
 3. Set Depth Regulator Lever to desired depth and increase engine speed. (When “practicing”, keep tines in the “Travel” position.)
 4. Move Tines/PTO Clutch Lever to ENGAGE position (if practicing, leave in DISENGAGE).
- IMPORTANT – Do not move Tines/PTO Clutch Lever to ENGAGE unless Wheels/Tines/PTO Drive Lever is in NEUTRAL. Tiller damage may occur!**

5. For forward motion of wheels and tines, squeeze and hold either or both Forward Interlock Levers (see Photo 4-7) against the handlebar grip, then move the Wheels/Tines/PTO Drive Lever down into FORWARD position.

6. When the tiller moves forward, relax and let the wheels power the tiller along while the tines dig. Walk behind and a little to one side of the tiller (on the side that is not yet tilled – see Photo 4-8). Use a firm grip with one hand on the handlebars, but keep your arm loose.

IMPORTANT– Let the tiller move ahead at its own pace. Do not push it ahead—this reduces operator control. Do not push handlebars down attempting deeper digging— this takes weight off the wheels, cuts traction, and causes the tines to try to propel the tiller.



WARNING

To avoid injury, keep hands, feet, legs, and clothing away from revolving tines.

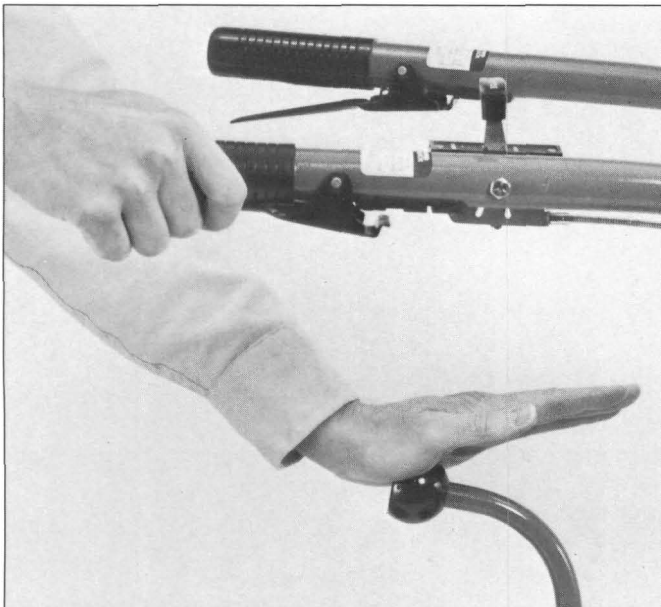

Photo 4-7: Squeeze either or both Forward Interlock Levers UP before moving Wheels/Tines/PTO Drive Lever down into FORWARD.



Photo 4-8: Guide tiller with one hand.

Operation

7. **To stop forward motion:** tap or lift Wheels/Tines/PTO Drive Lever up to NEUTRAL and let go of the Forward Interlock Levers. The wheels and tines will stop and the engine will continue running.

8. **In an emergency, stop all forward motion by letting go of all handlebar control levers— this shuts off the engine too.**

9. **For reverse motion:**

- a. Do not till while in REVERSE.
- b. Put Tines/Wheels/PTO Drive Lever in NEUTRAL and reduce engine throttle speed. Verify that the area behind you is clear.

- c. Move Wheel Speed Lever to the SLOW position.
- d. Move the Tines/PTO Clutch Lever to DISENGAGE.
- e. Lift up handlebars until tines are off the ground, then move (and hold) Wheels/Tines/PTO Drive Lever all the way up. The Forward Interlock Levers do not need to be squeezed to use reverse.

10. **To stop reverse motion:** Release the Wheels/Tines/PTO Drive Lever— it automatically returns to the NEUTRAL position. This stops the wheels immediately. (The Forward Interlock Levers will not stop REVERSE motion.)

To Stop the Engine

Move the engine throttle lever to the STOP position (and turn key to OFF on electric start models). Remove the key for safekeeping.



CAUTION

To Help Avoid Personal Injury or Damage to Equipment:

- Be sure no obstacles are behind you before operating the tiller in REVERSE.
- Disengage the tines, reduce engine speed, and move the Wheel Speed Lever to SLOW position before operating in REVERSE. Avoid using FAST wheel speed until you are used to reversing.

Turning Around

Turning the tiller around is easy and just requires practice. First find the balance point between the engine and the tines by lifting up the handlebars. Once you have found the balance point, then let the powered wheels do the “turning” as you push sideways on the handlebars in the direction of the turn. Practice the turning maneuver described here in a large open area. Once comfortable turning the tiller, you can then take it to the garden area. See Photo 4-9 below.

Turning Procedure:

1. At the end of a row, move the Wheels/Tines/PTO Drive Lever to NEUTRAL position and reduce the engine speed.
2. Move the Tines/PTO Clutch Lever to DISENGAGE position.
3. Resume forward operation, and lift handlebars until tines are above the ground. Find the balance point between the engine and the tines. Then PUSH the handlebars to swing the tiller around. *Be very careful to keep your feet and legs*

away from the tines (which should be disengaged). Let the powered wheels do the hard work. The inside wheel will pivot in place while the outside wheel drives the tiller around in the direction of the turn. Refer to Photo 4-9.

Note: Use REVERSE if necessary to turn in a limited space.

4. When the turn is complete, shift to NEUTRAL and lower the han-

dlebars. Move Tines/PTO Clutch Lever back to ENGAGE position and resume forward operation.



WARNING

To help avoid personal injury from revolving tines, always put the Tines/PTO Clutch Lever in DISENGAGE before turning tiller around.



Photo 4-9: To turn the tiller around most easily, lift up handlebars to find “balance” point between engine and tines, then push against handlebars in the direction of the turn while the powered wheels do the hard work.

Transporting Your Tiller

The tiller's powered wheels make moving the tiller to and from the garden easy when the engine is running. If the engine is off, you can also roll the tiller to another location if the Wheel Speed Lever is in the FREEWHEEL position.



WARNING

To help avoid personal injury from revolving tines, always move Tines/PTO Clutch Lever to DISENGAGE position before transporting, loading or unloading tiller.

To Transport The Tiller Around Your Property:

1. Place the Tines/PTO Clutch Lever in DISENGAGE position.
2. Move Depth Regulator Lever down all the way (TRAVEL setting).
3. If using *engine power*, move Wheel Speed Lever to either SLOW or FAST, and use the Wheels/Tines/PTO Drive Lever to drive the wheels.
4. If the *engine is stopped*, move Wheel Speed Lever to FREE-WHEEL, and manually push tiller.

To Load Or Unload The Tiller:

1. Use loading ramps that are strong and wide enough to safely hold the weight of the tiller and the operator combined— your tiller weighs between 280 and 325 lbs.

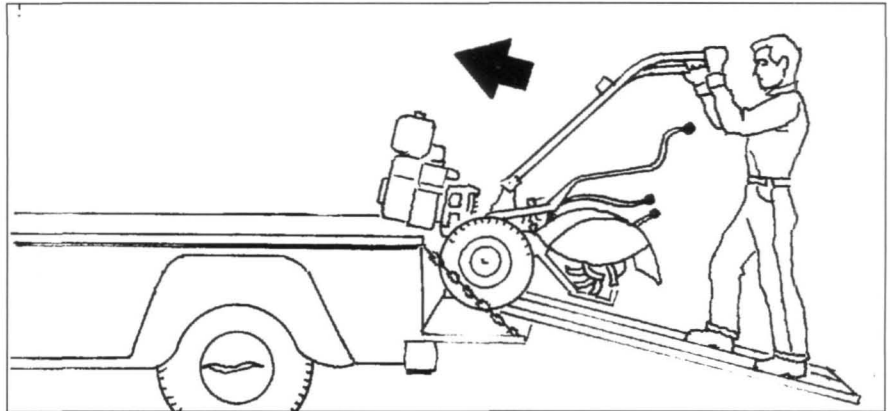

Figure 4-10: To go up ramps, use FORWARD drive.

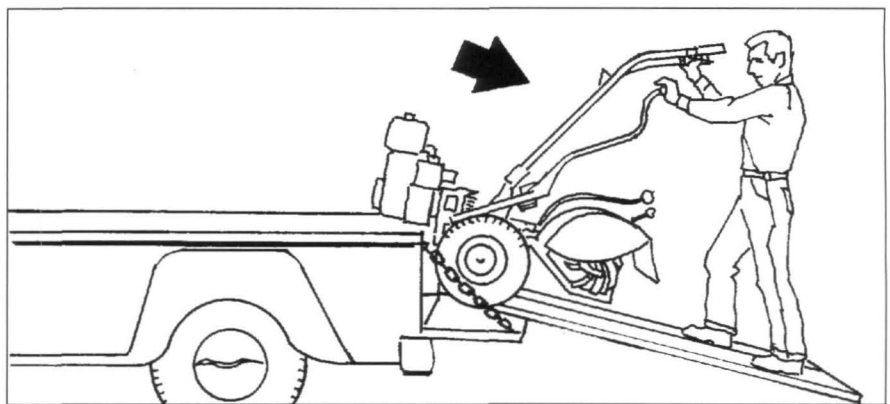

Figure 4-11: To go down ramps, use REVERSE drive.

2. Move the Tines/PTO Clutch Lever to DISENGAGE position.
3. Move Wheel Speed Lever to SLOW position and reduce the engine throttle speed.
4. **To go up ramps**, use FORWARD drive and follow the tiller up the ramps (Figure 4-10).
5. **To go down ramps**, use REVERSE drive and back down the

ramps. **Never go down the ramps in FORWARD drive since the tiller could tip forward, exposing you to the tines (which should be disengaged as we've recommended).** See Figure 4-11.

Operation

To Change Belt Speeds

Your tiller has two belt-driven speed ranges – HIGH RANGE and LOW RANGE – you pick one or the other by deciding which set of pulley grooves you move the forward belt into. By moving the belt from one speed range into the other, *in combination with* the FAST and SLOW wheel speeds offered by the Wheel Speed Lever, you obtain a choice of four different forward wheel speeds and two different tine speeds.

Changing the belt from LOW range into HIGH range (or back again) is simply a matter of moving the belt from one set of grooves on the engine and transmission pulleys to a second set of grooves. This change is done quickly without tools. See Photos 4-12 through 4-16 for reference.

By using the two belt speed ranges with the two Wheel Speed Lever positions (FAST and SLOW), here are the wheel speeds / tine speeds available to you:

At 3000 RPM engine speed, the wheel and tine speeds you can choose from are:

Belt Position	Wheel Speed Lever Position	Wheel Speed	Tine Speed
Low Range	Slow	.5MPH	146RPM
Low Range	Fast	1.2MPH	146 RPM
High Range	Slow	.7MPH	200 RPM
High Range	Fast	1.72MPH	200 RPM

When the tiller is moving in REVERSE, the wheels and tines are powered by the rubber reverse disc and not by the belt. So you have only two *reverse* speeds as determined by the SLOW and FAST positions of the Wheel Speed Lever.

IMPORTANT: Proper belt tension is important to good performance. Check tension after first 2 hours of new operation; then every 10 operating hours.

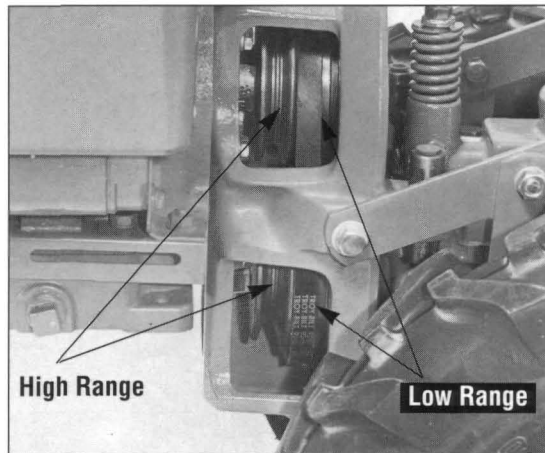

Photo 4-12: Belt range positions.



WARNING

To help avoid serious personal injury, stop the engine, remove the ignition key, disconnect spark plug wire and move the wire away from the spark plug, and let engine and muffler cool down before changing belt speeds.

To Change From LOW Range to HIGH Range

1. To avoid personal injury, shut off engine, let all moving parts come to a complete stop, then disconnect the spark plug wire and move it away from the spark plug before making any adjustments.

2. Place Wheels/Tines/PTO Drive Lever in NEUTRAL.

3. Kneel on *left side* of tiller. To create belt slack, reach over to *right side* of the pulleys and push in at the center of the belt with a finger. At the same time, use your left hand to work the belt part-way into the forward groove of the transmission (lower) pulley. See Photo 4-13. Now go to the other side of the tiller– finish seating the belt in the forward groove.

4. On the *left side* of the tiller, work the belt as much as possible into the forward groove in the engine (top) pulley. See Photo 4-14. Finish seating it from the *right side* of the tiller.

Note: If extra belt slack is needed to move the belt, just raise the Wheels/Tines/PTO Drive Lever up into REVERSE. This lowers the engine pulley, creating the slack.

5. Check *both sides* of the pulleys to see the belt is seated in HIGH range grooves of each pulley.

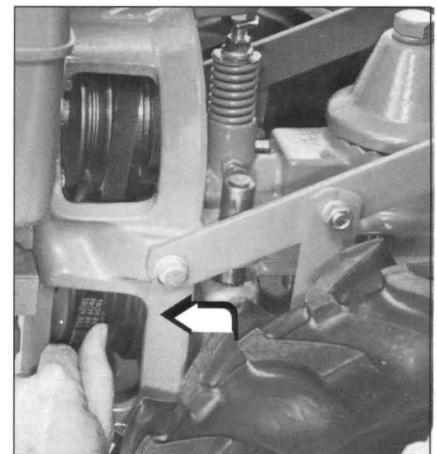

Photo 4-13: Move belt on transmission pulley into the forward groove.



Photo 4-14: Move belt on the engine pulley into the forward groove.

To Change From HIGH Range to LOW Range

1. To avoid personal injury, shut off engine, let all moving parts come to a complete stop, then disconnect spark plug wire and move it away from the spark plug before making any adjustments.
2. Move the Wheels/Tines/PTO Drive Lever to NEUTRAL.
3. Stand on left side of tiller. Use your right hand to hold the Wheels/Tines/PTO Drive Lever UP in REVERSE position. Then use left hand to move belt from front groove to rear groove on the engine pulley (top pulley). Refer to Photo 4-15. Go to right side of tiller and finish seating the belt.
4. Still holding the lever up in REVERSE position, move the belt



Photo 4-15: With Wheels/Tines/PTO Drive Lever held UP in REVERSE, move belt on engine (upper) pulley over into its rear groove.

from the front groove to the rear groove on the lower transmission pulley. Start at the left side of the tiller and finish seating the belt from the right side (Photo 4-16).

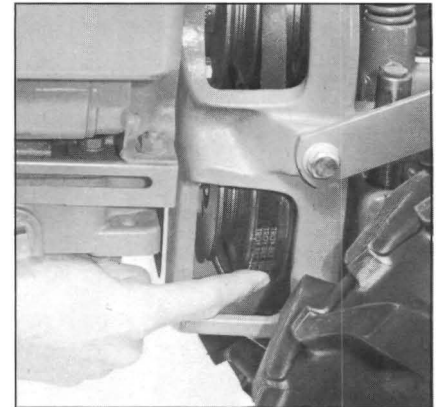

Photo 4-16: Now move belt on transmission pulley (lower pulley) over into its rear pulley groove.

5. Check that the belt is fully seated in the pulley grooves. Look at this from both sides of the tiller.

Choosing Tiller Wheel and Tine Speeds

Your tiller offers *four* wheel/tine speed combinations to handle every tilling task and garden job. By experimenting, you'll find the right tilling depth, engine speed, and wheel and tine speed combination that is best for the soil in your garden. Here's how to approach jobs:

1. Advance the throttle lever so the engine has sufficient power.
2. Do not set the depth regulator at too deep a setting to avoid having the engine labor or the tiller buck.
3. Your settings are "ideal" when the tines are breaking up the soil nicely, the engine is not laboring, and your progress is steady and smooth. See the Selection Guide below for hints.



WARNING

The HIGH speed belt range position combined with a FAST wheel speed setting propels the tiller at the fastest pace. To help avoid personal injury or property damage if using this speed combination, reduce the engine throttle speed.

WHEEL SPEED AND BELT RANGE SELECTION GUIDE

IMPORTANT — For correct wheel speed and belt range choices when using attachments or accessories other than tines, read the Owner/Operator Manual provided with the attachment or accessory.

SLOW GEAR, LOW BELT RANGE	SLOW GEAR, HIGH BELT RANGE	FAST GEAR, LOW BELT RANGE	FAST GEAR, HIGH BELT RANGE
Till in sod. Till in hard clay. Till under standing cornstalks in tough soil conditions. Till under cover crops. Prepare a deep seedbed. Till in stony soil. Till in residues and organic matter. Mix in fertilizers, manure.	Till in sod or hard clay. Till under standing cornstalks (slow, steady speed allows time to shred stalks). Till under cover crops (best wheel speed and belt speed range in most soils). Prepare seedbeds (best speed choice in most soils). Till in stony ground. Build raised garden beds. Mix in fertilizer. Use hiller wings in hard soil. Mix fertilizer and manure. Till residues, organic matter.	Go over seedbed for the last time before planting crops. Cover over seeds in wide row or plot planting (raise handlebars to avoid going too deep). Best for hilling and furrowing. Best for making raised beds. Cultivate (raise handlebars to avoid going too deep). Good for tilling large areas. Till organic matter in. Cultivating between raised beds with hiller-furrower attachment.	Prepare seedbeds for planting. Cover seeds with less need to hold up the handlebars. Cultivate (tiller travels faster, rides higher on the soil; allows engine RPM to be reduced; handlebars don't have to be raised). Keep large areas tilled and cultivated in the summer. Till under organic matter. Move tiller location quickly. Cultivate between raised beds using the hiller/furrower.

Operation

TILLING IN THE GARDEN

Here are tips and suggestions to help you get the most satisfaction and performance from your tiller.

Tilling Depths

When you begin tilling in the garden, please go slowly and easily at first. It's very important that you not try to dig too deeply too quickly. Soil that hasn't been tilled for some time must be tilled up gradually—it's almost impossible to dig down 4"-to-5" on the first pass with the tiller in compact soil.

IMPORTANT — Start tilling at a very shallow depth regulator setting, only 1" or 2" deep the first time through the garden area.

With each succeeding pass, you can adjust the depth regulator lever upward so the tines will dig another inch or two deeper. *Hint – water your garden area a few days before tilling to make the job much easier.* If it is difficult to dig down really deep, let the newly-worked soil "rest" for a day or two. It will then be easier to till.

Don't till when the soil is too wet. Wet soil will leave large clumps after tilling – and will only harden later. *Hint – test the soil by squeezing it – if it compresses too easily it's too wet to till.*



Photo 4-17: Use shallow depth regulator settings when tilling at first.

Seedbed Preparation

In a well-prepared seedbed, the soil will be loose and fine-textured. Try to till the first time a few weeks before the planting date; till the second time a few days later; then till the third time on the day of planting. This will make the seedbed as loose and well-aerated as possible.

When preparing the soil, go down the same path twice in the *first row*, then overlap each succeeding row by one-half the tiller's width. See Figure 4-18. Next, make a second pass through the seedbed at a right-angle to your earlier rows (refer to Figure 4-19). Again, overlap each row by one-half the width of the tiller. (In very hard ground, several passes over the seedbed may be needed.)

If there is not enough room to make a second pass at a right-angle, go back and repeat the first pass, overlapping the rows by one-quarter the width of the tiller.

Plan to expand your garden the following year? Bust up the sod in the Fall – the ground will be completely broken down when Spring arrives. You can also plant a cover crop in the Fall in that newly tilled area – the cover crop will keep the soil intact and enrichen it.

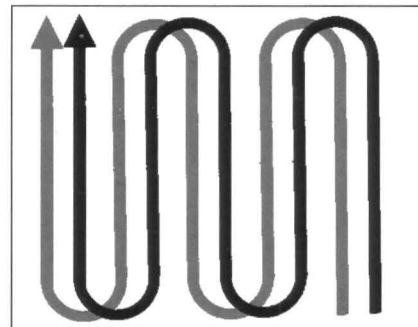

Figure 4-18: With each new row, overlap half of the previous row.



WARNING

To help avoid personal injury, be aware that the tiller can unexpectedly bounce up or jump ahead and be propelled away from you if the tines strike hard or frozen ground, or buried obstacles like large stones, roots or stumps. Always use the following precautions to help maintain control of the tiller:

- Walk behind and to the side of the tiller. Use one hand on the handlebars, relaxing your arm but with a secure hand grip.
- Use shallow depth regulator settings. Till gradually deeper.
- Use slower wheel, tine and engine speeds.
- Clear the tilling area of all large stones, roots and other debris.
- Do not put downward pressure on the handlebars. If needed, apply slight upward handlebar pressure to keep the tines from digging too deeply.
- Avoid contacting hard soil or sod at the end of a row – reduce engine speed and lift handlebars to raise tines out of the soil.
- *In An Emergency*, stop tines and wheels by moving Wheels/Tines/PTO Drive Lever to NEUTRAL. If you cannot reach the lever or have lost control, *Let Go Of The Handlebars and All Controls.*

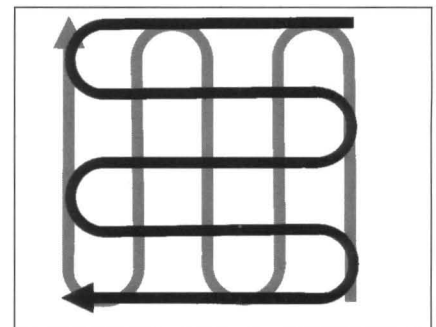

Figure 4-19: Till entire garden in one direction. Then at a 90° angle.

Avoid Making Footprints

When making final tilling or cultivating passes through the garden, try to walk on the side of the tiller where you will be on as-yet untilled soil. Don't leave footprints as shown in Photo 4-20.

Eliminating footprints means more than just a good appearance in your garden. The lack of footprints aids in preventing soil erosion and keeps weed seeds from being "replanted" in the newly tilled soil. Soil that hasn't been compacted by footprints is also easier for plant roots to grow in.



Photo 4-20: Avoid leaving footprints.

Cultivating

If you plan carefully before planting, you can leave enough room between plant rows for later cultivating with the tiller. That will eliminate hand-weeding or hoeing chores during the growing season!

The tiller hood is 22-½" across. Allow for that width between rows plus additional room for plant growth (particularly bushy crops like beans, tomatoes, peas, etc.) See Figure 4-21.

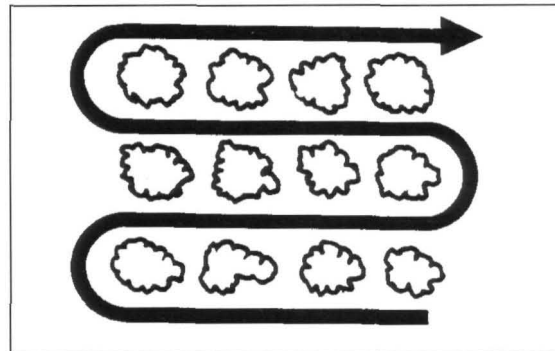

Figure 4-21: Allow sufficient room between rows for cultivating.

Power Composting

For a garden to be bountiful, the soil must be replenished regularly. Harvested produce removes nitrogen, phosphorous, and potassium from the soil — these plant nutrients must be replaced.

An easy and effective way to do this is to use your tiller to chop, blend, and turn under all kinds of organic matter (crop residues, leaves, grass clippings, etc.). This material decomposes during the off-season and releases nutrients into the soil. See Photo 4-22.

When power composting with your tiller, adjust the depth regulator to the deepest setting possible (move it up so one of the bottommost notches is engaged) without causing the engine to labor or the tiller to jump ahead. Till under crop residues as soon as possible after crop harvesting, as they'll till under more easily when green. Use the HIGH belt range and SLOW Wheel Speed Lever position when power composting. If necessary, move the belt to LOW range to slow down the tine speed.

Last, plant a cover crop to protect the soil during the non-growing season. Then, in the Spring, the cover crop can be tilled under a few weeks prior to planting, providing more organic matter to help feed the soil.



Photo 4-22: After harvesting produce, till under crop residues to add nutrients to the soil.

SPECIAL TROY-BILT GARDENING TECHNIQUE— *Till Under Standing Cornstalks*

After corn is harvested, the stalks should be tilled into the soil while still green. If you wait until they've dried out, they'll be harder to till under, and the roots will break loose from the soil which you don't want! (*Don't pull the roots out by hand or cut the stalks before tilling — it is only when the stalks are still firmly anchored by their roots that the chopping and cutting action of the tines gets a chance to work best.*)

Three Rules For Tilling Under Cornstalks

Knocking down cornstalks and tilling them into the soil is not hard to do if you understand three basic principles: **First** – As you move forward into a row of stalks, aim the tiller so the stalks go between the left wheel and the transmission case (see Photo 4-24). Don't use the right wheel because damage could occur to the air cleaner, carburetor or throttle linkage.

Second– Each new pass should overlap the previous pass by one-half the width of the tiller.

Third – Till as deeply as possible.

Pull the Depth Regulator all the way UP and engage the lowest notch for deep tilling. Use either LOW or HIGH belt range and SLOW wheel speed gear position.

Note: Depending upon the size and height of the stalks, you may be able to use LOW belt range and FAST wheel speed gear.

Let the tilled in stalks decompose for a week or so. Then till in the remaining residue as deep as possible. Again, overlap your tilling passes so everything gets thoroughly processed. After another week, sow a cover crop, like annual rye grass.

Photo 4-23:
FIRST PASS – Till along first cornstalk row, with right tiller wheel up against but not touching cornstalks, to loosen the soil next to the cornstalks.



Photo 4-24:
SECOND PASS – Approach the row of cornstalks from the opposite direction. Align tiller so row of stalks is between left wheel and transmission case. Knock down stalks, partially burying them.

Photo 4-25:
THIRD PASS – Go back over the stalks you knocked down from the opposite direction. This buries much of the residue 3"-to-4" deep.



Photo 4-26:
FOURTH PASS – Till between the buried row and the next standing row to loosen soil. Now repeat instructions given for the first three passes.

Clearing Debris From The Tines

The Bolo Tines have a self-cleaning action which reduces most vegetation tangling in the tines. However, grass, string, or tough vines can get tangled. It's not necessary to remove all the material, but you should get enough out so the action of the tines isn't impaired.

To avoid tangling:

- Set depth regulator lever for deep

tilling— this results in maximum chopping action.

- Till under crop residues or cover crops while still green.
- Sway handlebars from side to side (6"-to-12" either way) when power composting – this can clear tangled tines.

If tangling occurs, *stop the engine, disconnect the spark plug wire, let all moving parts stop*, then use a pocket knife or linoleum knife to clear away the tangled materials.



WARNING

To help avoid personal injury, stop the engine, remove the electric start key, then disconnect the spark plug wire and move the wire away from the spark plug before attempting to clean the tiller tines by hand.

Tilling Up And Down Slopes

Planting space may be so limited that you only have sloped ground available for your garden. If so, please follow two very important guidelines for tilling on slopes: **1)** till only on moderate slopes, never on steep ground where footing is difficult; **2)** we recommend you plant rows up and down the slope (rather than terracing crossways) to get more planting room and also sufficient room for cultivating. See Photo 4-27.

Growing a garden vertically on a slope doesn't have to mean soil erosion will be a major problem. You just need to put in enough organic matter so the soil has good moisture-holding ability, and you need to avoid making footprints or leaving wheel marks. This keeps erosion to a minimum.

When tilling vertically on a slope, try to make the first pass in an uphill direction. The tines will dig more deeply than when going downhill. You may have to lift the handlebars slightly going uphill. When tilling down the slope, overlap the previous uphill pass by half a tiller width. *Hint: for best results, use the HIGH belt range and SLOW wheel speed lever position.*



CAUTION

TO AVOID SERIOUS PERSONAL INJURY OR DAMAGE TO EQUIPMENT:

- Do not operate tiller on a slope too steep for safe operation. Go slowly on any slope. Make sure you have good footing.
- Wear footwear that increases stability and reduces slippage.
- Do not use FAST wheel speed position when on sloped ground.
- Do not shift the Wheel Speed Lever when heading up or down a slope. If lever is accidentally moved to FREE WHEEL position, the tiller could roll out of control.

- To prevent engine damage due to oil starvation (on slopes, the engine is inclined and oil moves away from surfaces that need lubrication), be sure the correct oil level is maintained during all uphill/downhill tilling operations. Check the level of the oil in your engine after every one-half hour of operation.



Photo 4-27: Tilling on a moderate slope. (Don't till on steep ground.)

Operation

Terrace Gardening

If a slope is too steep or not long enough for vertical tilling, it may be necessary to till *across* the slope and create *terraced* rows. Terraces are rows that are cut into the side of a slope, creating a narrow, but flat area on which to plant. On a long slope, you can make several terraces, one below the other on the slope.

IMPORTANT: Do not till across a slope without creating terraces. Simply tilling across the slope and leaving unterraced rows on the slope creates hazardous footing for you, and invites soil erosion. When you will be making rows across a slope, be sure they are terraced rows.

Terraces should be made about two-to-three feet wide. This will allow one or two rows of plants on the terrace, and allow enough room to till under crop residues. However, with a terrace this wide there may not be enough room for cultivating. *Hint: If you make terraces too wide, you'll be digging far into the hillside, exposing poor subsoil in which plants will not be their most productive.*

Move the belt into LOW belt range and the Wheel Speed Gear Lever to SLOW position. Start to terrace at the *top* of the slope. Go all the way across the slope several times until the first terrace is made. See Figure 4-28 and Photo 4-29. As you work down the slope, always keep the *uphill* wheel in the soft, newly tilled soil. Each suc-

ceeding terraced area is started by walking *below* the terrace you are preparing. In four or five passes, the tiller can carve out a flat and wide enough terrace for planting.

Don't till the last 12-inches (leave at least that much soil untilled) of the downhill outside edge of each terrace. Keeping this strip untilled helps prevent your terraces from breaking apart and washing downhill. This untilled strip also gives you a walking path between terraces.

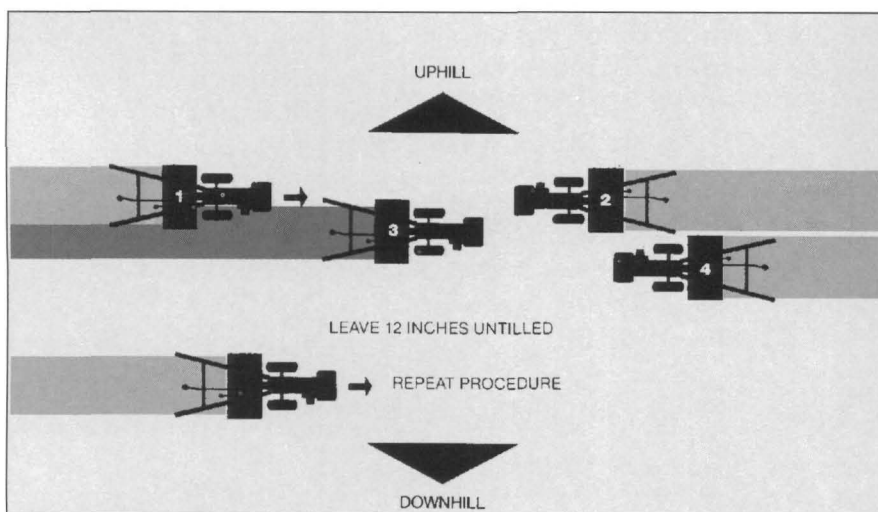

Figure 4-28: How to make a terrace in just 4 or 5 passes with the tiller.



Photo 4-29: Make a terrace in just 4 or 5 passes with the tiller.

Soil Enrichment Idea

Trench Composting — Trench composting is easy with the optional Hiller-Furrower Attachment (see Section 5). Just dig a trench, put in all kinds of organic matter, and cover with soil. Earthworms and microbes will break it down quickly.

Tilling Across Slopes Without Terraces

Tilling across a slope without forming terraces is not recommended. Of course it can be done, but do study your terrain carefully and try to avoid going across a slope without making terraces. See if it isn't possible to till vertically up and down the slope or, as a second option, to create terraces.

Again, you should make certain that the slope is not too steep to till on at all. If it's safe, you can

begin making unterraced passes across the slope by starting at the very top of the slope. Make your second pass by overlapping half the width of the first pass. Always keep the *uphill* wheel in the soft, newly tilled soil. This will increase the stability of the tiller. For best results, move the belt into LOW belt range and the Wheel Speed Gear Lever into the SLOW position.

SPECIAL TROY-BILT GARDENING TECHNIQUE— *Making Raised Beds For Planting*

If you have wet soil or heavy clay soil, most crops won't grow well due to a lack of air and nutrients. Raised beds can help solve these problems. In addition, they provide a good irrigation system, give more sun to the plants, and foster good root growth. Raised beds are easily made too with the optional Hiller-Furrower attachment.

You can even try wide-row planting on raised beds. Wide rows can be spaced from 30 inches to 36 inches apart, and from 8 inches to 10 inches high.

Photos 4-30 through 4-33 at right show you the steps to take to create raised beds. After working the soil to a fine seedbed, attach your Hiller-Furrower and use it to make your rows. The hiller wings will raise up the soil, creating the foundation for the raised beds. After you plant seeds on the ridges of each row, rake the ridges flat. Then use the tiller with the furrower to make irrigation trenches at the end of each row.



Photo 4-30: Step 1 — Work soil to a deep, smooth, loose seedbed.



Photo 4-31: Step 2 — Put row marker stakes at proper intervals. Attach Hiller-Furrower to make rows.



Photo 4-32: Step 3 — After planting seeds on the ridges, rake loose soil over the top. Firm the soil per seed directions.



Photo 4-33: Step 4 — Use furrower blade attachment to make irrigation trenches at the ends of each row.

SPECIAL TROY-BILT GARDENING TECHNIQUE— *Wide-Row Planting*

Wide-row planting is a very productive gardening technique we suggest you try. As the name implies, seeds are broadcast in bands anywhere from 10 inches to 2 feet wide or more, rather than in traditional, narrow single rows. As a result, you'll typically grow anywhere from 3 to 4 times (or more) produce in the same space normally set aside for an area that has narrow, single rows.

Wide-row planting (see photos at right) automatically shades the ground which keeps weed growth down and also holds moisture in the soil. And of course, harvesting is much easier — everything is right at hand to be picked. Preparing wide rows is easy — after you prepare the seedbed and mark off the rows with string, just hand-broadcast the seeds as seeding a lawn (not quite as much as lawn seed). Cover with soil and tamp the area firmly with a hoe.



Photo 4-34: Wide-row planting on the right compared to single-row planting on the left.

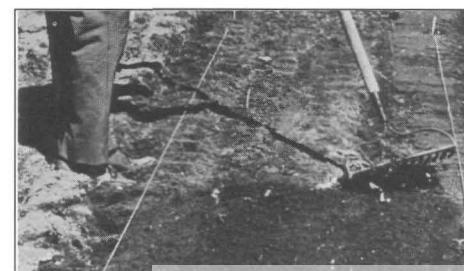

Photo 4-35: After preparing seedbed, mark off the row area as wide as you want, up to 4-feet across.

THE PTO POWER UNIT

As explained on Page 2 of this Manual, your tiller is really a self-contained PTO power unit that was shipped to you with a tine attachment connected to it. The tine attachment is quickly removed and replaced by other attachments that are available from us. The instructions given here will familiarize you with your PTO Power Unit. Please read these pages carefully.

VERY IMPORTANT

Before operating your PTO Power Unit for the first time, make sure that you have:

- Read all the safety instructions in Section 1 of this Manual and in the Manual supplied with any attachment.
- Read the controls information and operating procedures for the tiller and engine described in Sections 3 and 4 of this Owner/Operator Manual.
- Read and understand the assembly instructions, controls information, and operating procedures for the attachment as described in the Owner/Operator Manual that is supplied with the attachment.

Removing And Replacing The Tine Attachment

The following steps explain how to remove and replace the tine attachment. The only tool you will need is a 3/4" wrench (minimum 12" long for good leverage).

There are two optional accessories that make the following steps easier. The Kickstand accessory prevents the PTO Power Unit (engine end) from falling forward

when an attachment is removed (Photo 4-37). The Tine Attachment Cradle accessory gives you a handy support in which to rest the tine attachment when it is removed from the tiller (see Photo 4-38). For more information about other accessories, refer to "Accessories" at the back of this Manual.



CAUTION

TO AVOID PERSONAL INJURY OR DAMAGE TO EQUIPMENT:

- Stop the engine, remove the electric start key, disconnect the spark plug wire and let the engine and muffler cool before removing or installing any attachment.
- Do not place hands, tools, or any object near or inside the PTO access hole when the engine is running.
- When removing or replacing the tine attachment, be careful of the sharp edges on the tiller hood. Wear thick gloves for hand protection.
- When the tine attachment is removed, always place it in the Tine Cradle or prop it up to prevent the attachment from falling forward.

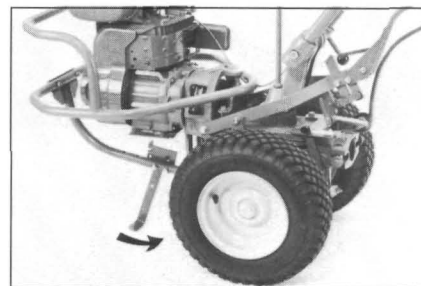

Photo 4-37: The Kickstand accessory prevents engine from tipping.

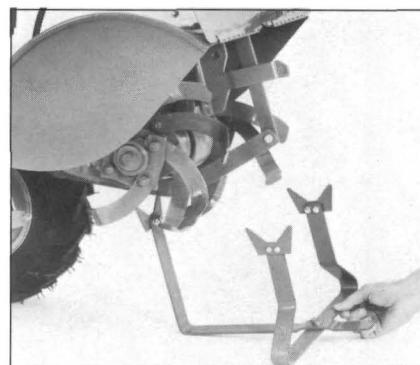

Photo 4-38: The Tine Attachment Cradle accessory is a handy option.

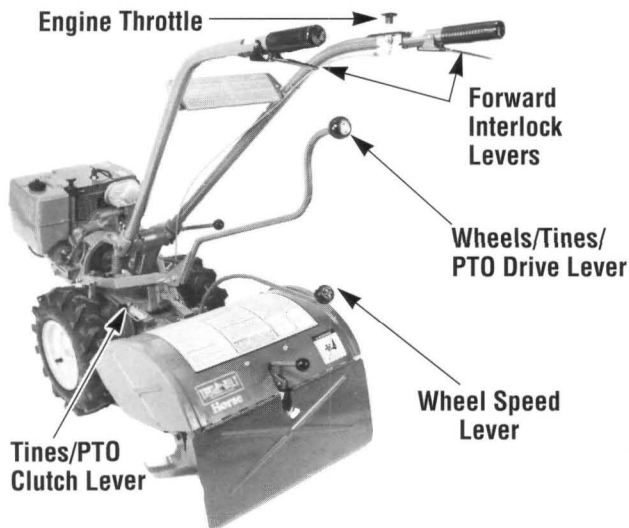

Photo 4-36: The PTO Power Unit with the tine attachment removed.

To Remove Tine Attachment:

1. First be sure the engine is stopped, the electric start key is removed, and the spark plug wire is disconnected.
2. Place tiller on level ground.
3. Place the Wheels/Tines/PTO Drive Lever in NEUTRAL (refer to Photo 4-39).

Photo 4-39:
PTO Power
Unit controls.



4. Place Tines/PTO Clutch Lever in DISENGAGE (Photo 4-39).

5. Place Wheel Speed Lever in FREE WHEEL (Photo 4-39).

6. Place a strong support under the engine or use the Kickstand accessory (if so equipped) to prevent the engine from tipping forward when the tine attachment is removed. See Photo 4-40.

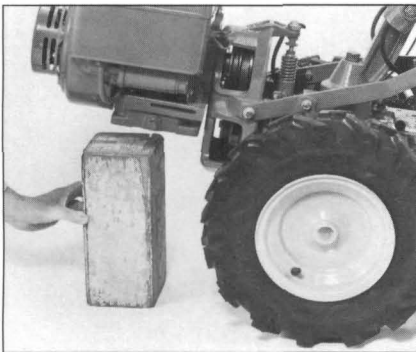

Photo 4-40: Block up engine.

7. With a 3/4" wrench, loosen the two swing-out bolts that connect the power unit transmission to the tine attachment and swing the bolts outward. See Photo 4-41. *Hint: an extra-long wrench for leverage is very helpful.*

8. Use one hand on the handlebars to tip the power unit forward about one inch while pulling the tine attachment backward. The guide pin on the power unit will release from the guide hole in the tine attachment. See Photos 4-42 and 4-43.

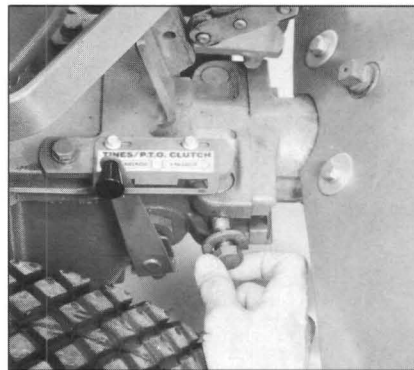

Photo 4-41: Move both of the swing-bolts outward.

Note – Store tine attachment at level position to avoid gear oil leakage around dipstick.

9. Place the dust cap (comes with certain attachments; plastic wrapping will substitute) over the “dog” clutch coupling of the tine attachment to keep it clean.

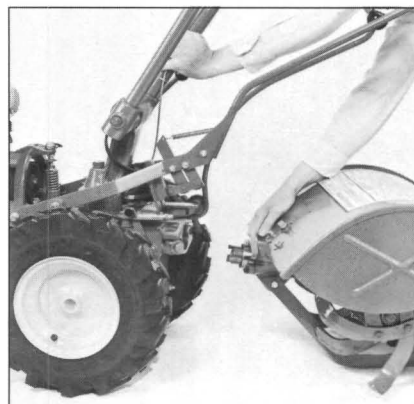

Photo 4-42: Lift handlebars while pulling attachment away from power unit.

10. The power unit is now ready to accept any other powered or non-powered attachment. See that attachment’s Owner/Operator Manual for installation and operation instructions.

To Replace Tine Attachment:

1. Follow Steps 1-through 5 of the previous tine attachment removal instructions.

2. Move the two swing-out bolts on the power unit to their outward position (slide the washers next to the bolt heads too).

3. Slowly roll the power unit back to the tine attachment. Move the Kickstand down (or support the engine with a wood block).

4. Remove the dust cap (or protective wrapping) from the clutch coupling on the tine attachment.

5. Carefully align the alignment pin on the power unit with the alignment hole in the tine attachment and bring the two units together (see Photo 4-43).

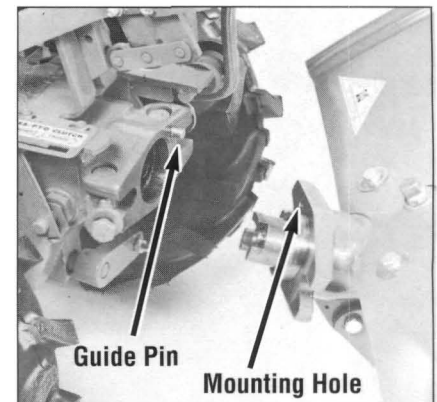

Photo 4-43: Align the guide pin with the mounting hole.

Operation

6. Move the two swing-bolts into the slots of the tine attachment. Alternately tighten each bolt until they are tight enough to make the concave washers on the bolts flat. *The bolts must be very tight – if you have a torque wrench, tighten each one to between 70-80 ft.-lbs.* See Photo 4-44.

IMPORTANT – The swing-bolts must be kept very tight to prevent damaging wear to the ‘dog’ clutch couplings, alignment pin or the alignment hole. Check bolt tightness every 2-½ operating hours.

7. Remove the engine support before moving the tiller in a forward direction.



Photo 4-44: Tighten both swing-bolts very securely with a long 3/4" wrench. Tighten them to between 70-to-80 ft. lbs.

PTO POWER UNIT OPERATING INSTRUCTIONS



WARNING

To help avoid personal injury or damage to equipment, read the Owner/Operator Manual supplied with each attachment before installing or operating the attachment. See all detailed use and operation information and all safety instructions.

The following instructions describe how to operate the PTO Power Unit **only**. Read the separate Owner/Operator Manual supplied with each attachment before attempting to assemble, attach, transport or operate the attachment. If needed, please contact us for a replacement manual.

Some attachments have a drive shaft or a hydraulic pump that is powered by the engine on the PTO Power Unit. These attachments are called “Stationary Attachments,” since they must remain in one location when being operated (they can be towed to a work site by the PTO Power Unit as described in “To Operate Non-Powered Attachments”).

Other attachments are simply pulled or towed behind the PTO Power Unit. These attachments are called “Non-Powered Attachments.”



WARNING

To help avoid personal injury, always disengage the Tines/PTO Clutch Lever before towing any attachment.

Before Starting The Engine:

IMPORTANT – Before operating in temperatures below 40°F, refer to “Cold Weather Operation” instructions in Section 4.

1. Move the Wheels/Tines/PTO Drive Lever to NEUTRAL. To find NEUTRAL (be sure engine is off), push lever down to engage it in FORWARD, then tap or lift the lever up and release it (Photo 4-39).

2. Move the Tines/PTO Clutch Lever to DISENGAGE.

3. For Stationary Attachments Only:

a. Move Wheel Speed Lever to FREE WHEEL, then block all wheels to prevent the equipment from rolling. Refer to Photo 4-39 and Figure 4-45.

b. On the Power Unit, unplug the Forward Interlock Wire Harness that leads from the bottom of the handlebars to the receptacle located on the top, right side of the transmission cover (see Figure 4-46).

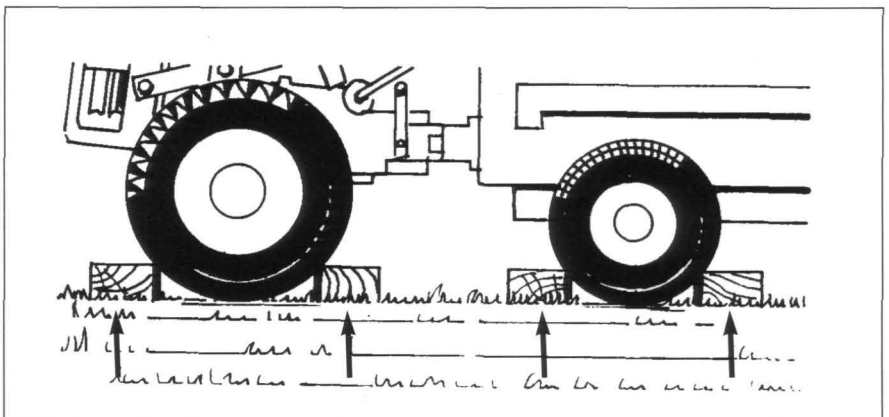
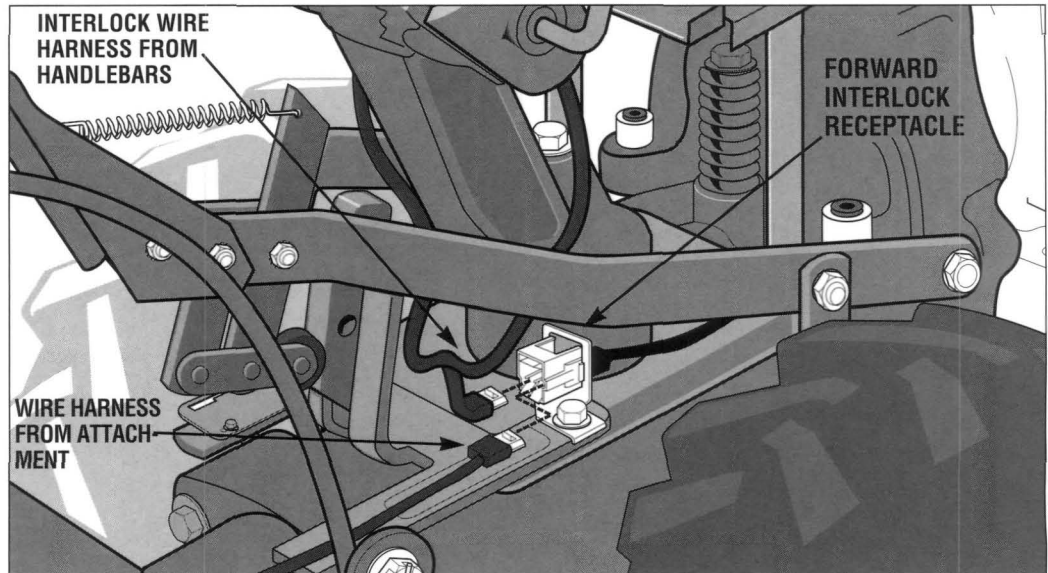

Figure 4-45: Block wheels on power unit and stationary attachment.

Figure 4-46: Disconnect the Forward Interlock Wire Harness coming from the handlebars that connects to the receptacle on top of the transmission. Then connect the wire from your Stationary Attachment to the receptacle on top of the transmission. Verify the connection is secure.



c. On the Stationary Attachment, locate the interlock wire and be sure the plug is clean.

d. Connect the plug from the Stationary Attachment to the receptacle on the Power Unit. See Figure 4-46. The connection must be tight. This connection allows you to operate the Wheels/Tines/PTO Drive Lever in FORWARD without having to constantly squeeze one of the Forward Interlock Levers.

4. For Non-Powered Attachments Only:

a. Move the Tines/PTO Clutch Lever to DISENGAGE.

b. Move the Wheel Speed Lever to either SLOW or FAST position (roll tiller power unit while shifting lever until wheels are engaged.) See Photo 4-39.

c. Verify that the Forward Interlock Wire Harness plug at the bottom of the handlebars is connected to the Forward Interlock Wire Harness receptacle on the top right side of the transmission (Figure 4-46).

5. Move the Engine Throttle Lever away from the STOP position and use the Choke Control if

engine is cold. Pull out the Recoil Start Rope (or use keyswitch on electric start models). When engine starts, move Choke Control to CHOKE OFF and let engine warm up. (See Section 4 – Page 27 for detailed starting steps).

6. For non-powered attachments *only*, test the Forward Interlock Safety System (Section 4 – Page 26).



WARNING

To avoid injury, do not run the engine in an enclosed or poorly vented area. Engine exhaust contains carbon monoxide, an odorless and deadly gas.

To Operate Stationary Attachments:

1. Put Tines/PTO Clutch in ENGAGE.

2. To apply power to PTO-driven attachments, move Wheels/Tines/PTO Lever down to FORWARD position (do not use REVERSE with stationary attachments).

3. **To Stop PTO Power:** Tap or lift the Wheels/Tines/PTO Drive Lever up to NEUTRAL position.

To Operate Non-Powered Attachments (or to Tow Stationary Attachments):

1. To go forward, squeeze and hold one Forward Interlock Lever (refer to Photo 4-39) up against the handlebars, and move the Wheels/Tines/PTO Drive Lever down to FORWARD.

2. **To Stop Forward Motion:** Tap or lift the Wheels/Tines/PTO Drive Lever up to NEUTRAL, then release Forward Interlock Levers.

3. To stop forward motion in an emergency— Let go of **all** power unit controls (this stops the engine).

4. For reverse motion, first reduce the engine speed and put the Wheel Speed Lever in SLOW. Then move and hold the Wheels/Tines/PTO Drive Lever up for reverse motion (the area behind you must be clear of all obstacles).

5. **To Stop Reverse Motion:** Release the Wheels/Tines/PTO Drive Lever.

To Stop The Engine:

Move the Engine Throttle Lever to STOP (and turn Keyswitch to OFF on electric start models).

Section

5

Maintenance/Repairs



Carefully read this Section on tiller and engine maintenance and service. Performing the required maintenance according to schedule will ensure the proper performance and long life of your machine.



CAUTION

Before inspecting, cleaning or servicing the machine, shut off engine, wait for all moving parts to come to a complete stop, disconnect spark plug wire and move wire away from spark plug.

Failure to follow these instructions can result in personal injury or property damage.

NOTE: All references to left, right, front and rear of the machine are determined by standing behind the handlebars and facing the direction of forward travel.

Subjects covered in this Section include:

- Tiller Maintenance
- Engine Maintenance
- Storing Your Tiller
- Troubleshooting
- Specifications
- Attachments

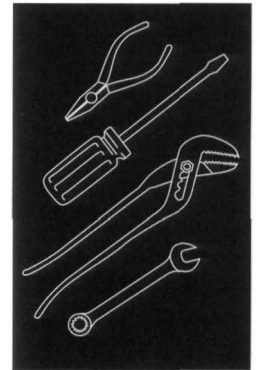

REQUIRED MAINTENANCE SCHEDULE

PROCEDURE	Before Each Use	Every 10 Hours	Every 25 Hours	Every 30 Hours	As Noted
Check engine oil level	•				Every 5 operating hrs.
Clean engine cooling system	•				
Test operation of Forward Interlock Safety System	•				See Sec 4
Forward Interlock Safety System – check wire condition, connections		•			
Check battery electrolyte level and electrical connections		•			
Recharge battery					Before/after long storage
Check drive belt tension		•			After initial 2 hours
Check nuts and bolts		•			After initial 2 hours
Clean tiller tine shaft		•			
Lubricate tiller		•			
Change engine oil*		•			More often in dusty or dirty areas
Clean foam element air filter Check paper element air filter			• •		More often in dusty or dirty areas
Check for oil leaks			•		After initial 2 hours
Check gear oil level in both transmissions				•	After initial 2 hours
Check bolo tines for wear				•	
Check reverse disc for wear				•	
Check air pressure in tires				•	

* During engine break-in period, change engine oil after first 5 hours of operation.

TIGHTEN BOLTS AND NUTS



WARNING

To help avoid personal injury, stop the engine, remove the electric start key, disconnect the spark plug wire and move the wire away from the spark plug, and let the engine muffler cool before inspecting or servicing the tiller or engine.

Check for loose or missing hardware every ten (10) operating hours. Failure to tighten or replace fasteners can cause poor performance, equipment damage or oil leakage. See your Parts Catalog for complete fastener descriptions.

Most hardware on your tiller is visible. Pay particular attention to hardware shown in Photos 5-1, 5-2, 5-3, and Figure 5-3A.

1. Check the transmission pulley mounting bolt (Photo 5-1). If the washer behind the bolt head is loose, the bolt needs tightening. To do this, first insert a punch or thick screwdriver into the hole next to the bolt and wedge the tool

against the side of the motor mount casting. This “freezes” the pulley while you tighten the bolt.

2. Check jam nut on left side of neutral plunger assembly (Photo 5-2). If loose, immobilize bolt head with one wrench and use another wrench to tighten the nut.

3. Check the three rear bearing cap screws under the depth regulator mounting bracket (“A”, Photo 5-3). If any is loose, it can cause an oil leak or drive shaft end play.

4. Check the five bolts securing the tiller housing cover to the left side of the transmission (“B” in Photo 5-3). Gear oil can leak from a loose housing cover. To reach the bolts, remove the left side tine holder. See “Bolo Tine Maintenance” in this Section for tine holder removal directions.

5. Check both swing-bolts (“C”, Photo 5-3) that connect the power unit transmission to the tine attachment. Both bolts should be checked every 2-1/2 hours of operation. If loose, wear can occur on the locating pin on the power unit,

and cause enlargement of the locating hole in the tine attachment. Using a torque wrench, tighten these bolts to 70-to-80 ft.-lbs.

6. Check the locknut that fastens the shifting linkage to the eccentric shifting lever (“D”, Photo 5-3). Do not tighten the locknut against the eccentric lever. It should be very close to, but not touching the lever.

7. Check the four bolts and nuts securing left and right tine holders to the tine shaft (Figure 5-3A).

IMPORTANT— Give screws or bolts that go into the transmission housing a coating of non-hardening gasket sealant to prevent gear oil from leaking.

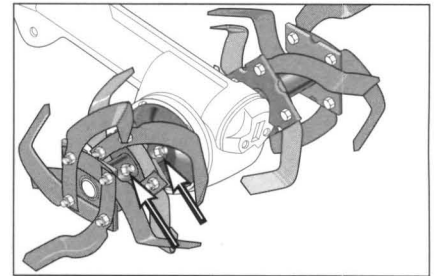

Figure 5-3A: Tine holder hardware must be tight.

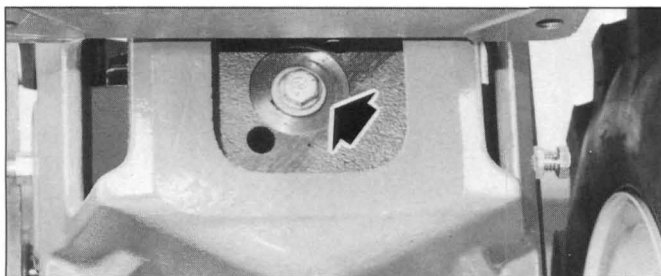

Photo 5-1: Check bolt on transmission pulley.



Photo 5-2: Check jam nut on plunger assembly.

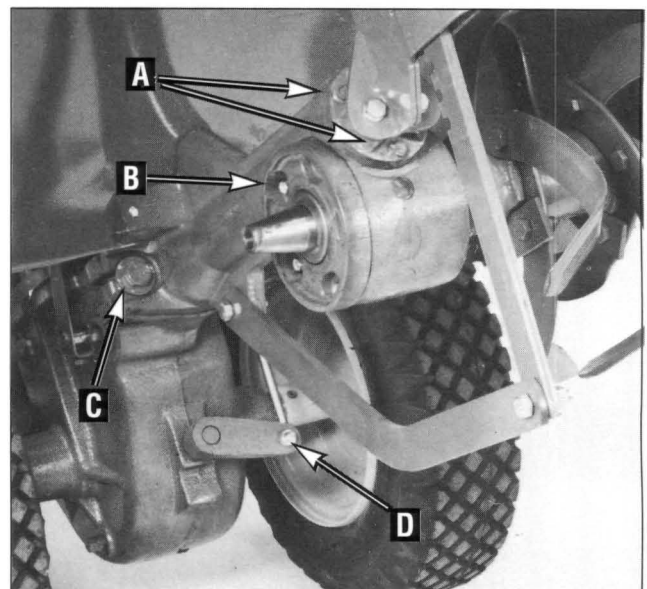

Photo 5-3: Gently tilt tiller forward to check fasteners.

TILLER LUBRICATION



WARNING

To help avoid personal injury, stop the engine, remove the electric start key, disconnect the spark plug wire and move the wire away from the spark plug, and let the engine and muffler cool before inspecting or lubricating the tiller.

Proper lubrication of the tiller's mechanical parts is an essential part of good maintenance. Lubrication should be done after every ten (10) hours of operation.

Use ordinary motor oil (#30 weight or lighter) where oil is specified. Use a quality grease with a metal lubricant where grease is recommended (regular grease is acceptable). Do not over-lubricate. If there is a build-up of dirt, remove the build-up and re-apply oil or grease.

IMPORTANT – Do not allow oil or grease to contact the pulleys, drive belt or reverse disc. This

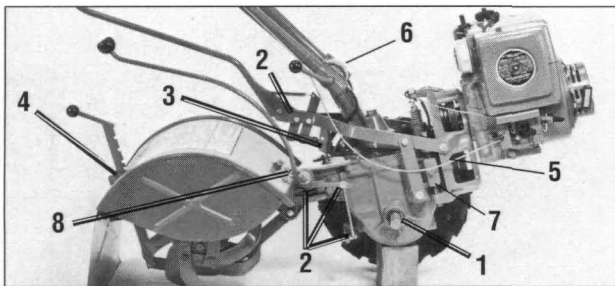

Photo 5-4: Tiller lubrication points (wheel removed for clarity).

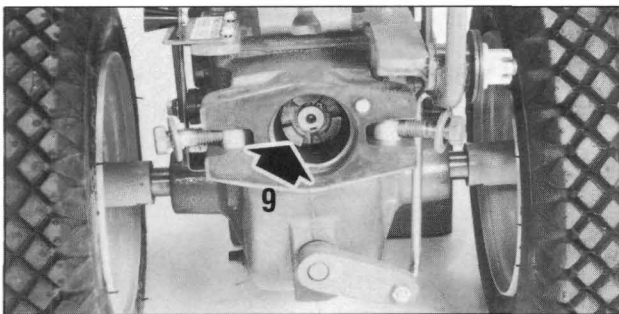

Photo 5-5: Use grease liberally in PTO access hole.

can cause the belt or disc to slip on the pulleys.

Lubricate the numbered areas in Photos 5-4 and 5-5, as follows:

1. Oil the wheel shaft between the wheel hubs and the transmission housing (Photo 5-4).
2. Oil all pivoting and connecting points on the Wheels/Tines/PTO Drive Lever and the Wheel Speed Lever (Photo 5-4). If Wheel Speed Lever has a grease fitting on pivot assembly, apply 2-to-3 strokes of multi-purpose grease at beginning and end of tilling season.
3. Grease the face of the belt adjustment block (Photo 5-4).
4. Oil the Depth Regulator Lever, including the spring in the mounting bracket (Photo 5-4).
5. Oil the full length of the throttle cable casing (Photo 5-4).
6. Oil threads on Handlebar Height Adjustment Lever (Photo 5-4).
7. Grease left- and right-side engine mounting bars at the top, the middle, and bottom (Photo 5-4).

8. Grease the zerk grease fitting located on the pivot point at the end of the Wheel Speed Lever (Photo 5-4).

9. Keep the PTO access hole well-greased (Photo 5-5). If the Tines/PTO Clutch Lever becomes hard to move, squirt some oil into its access hole, and work it back and forth to disperse the oil.

TRANSMISSION GEAR OIL MAINTENANCE



WARNING

To help avoid personal injury, stop the engine, remove the electric start key, disconnect the spark plug wire and move it away from the spark plug, and let the engine and muffler cool before inspecting or servicing the tiller.

A. Checking for Oil Leaks

At 25-hour operation intervals, check the tiller for oil leaks. Inspect for oil accumulations on the tiller or the floor where it's stored.

A small amount of oil seepage or wetness around a shaft opening or cover is no cause for alarm. But a heavy concentration of oil is more serious. You should tighten all bolts immediately, and replace any worn seals or gaskets.

It may be impossible to determine how much oil has been lost, so check the oil levels in the PTO transmission and the tine attachment before using the tiller again. Add any necessary gear oil. Serious damage to the transmission components can result from operation when gear oil levels are low.

If tilling during very hot weather, the gear oil may heat up and expand inside the transmissions. To allow for this oil expansion, both the power unit transmission and the tine attachment transmissions have oil relief vents (see Figure 5-6).

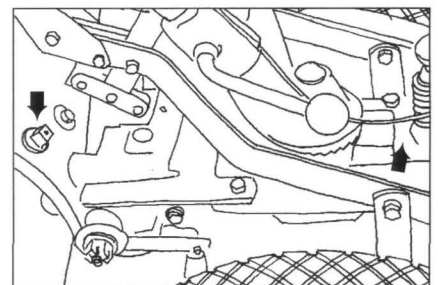

Figure 5-6: Oil relief vent locations.

The vents allow small amounts of oil to seep out.

If a serious leak is discovered, please contact our Technical Service Department for parts and service advice.

B. Checking Gear Oil Levels

Every 30 hours of operation, check the gear oil level in both the power unit transmission and the tine attachment transmission. Operating them while low on gear oil (even briefly) can cause serious damage to internal components.

Preparation:

1. The transmissions must be cool, since hot gear oil expands and gives a false reading.

2. The power unit transmission and the tine attachment transmission must be connected when checking (or adding) gear oil.

To Check the Power Unit Oil Level:

1. Move the tiller to level ground. Move the Depth Regulator up so the tines rest on the ground.

2. Use a 3/8" wrench to remove the oil level check plug on the left side of the transmission housing (refer to Figure 5-7).

3. If the oil level is correct, oil will seep out of the check hole (allow extra time in cold weather). If it does, the level is fine and you

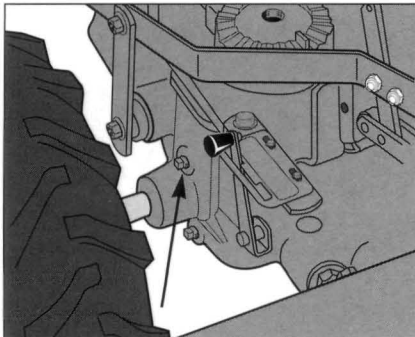

Figure 5-7: Remove oil level check plug. Gear oil should seep out if the level is sufficient.

should replace the check plug. If no oil seeps out, see "C. Adding or Changing Gear Oil."

To Check the Tine Attachment Oil Level:

Two different gear oil checking procedures for the tine attachment transmission are described next. Use the first procedure if the dipstick in your tine attachment has only a 'Check Cold' marking. Use the second procedure if the dipstick has both 'cold' and 'hot' markings at the end. *First remove the dipstick from the tine attachment transmission (Figure 5-8) to see which type dipstick you have. Then replace the dipstick.*

For Dipsticks With 'Check Cold' Marking:

1. Put the tiller on level ground.

2. Pull the Depth Regulator Lever back, then push it down all the way (to engage its top notch). This lifts the tines off the ground and lets the tiller rest on its drag bar.

3. As you'll be propping up the rear of the tiller next, first place a support under the engine to prevent the tiller from tilting too far. Now slide three pieces of 2"x4" lumber underneath the drag bar—raising the drag bar about 4-1/2"

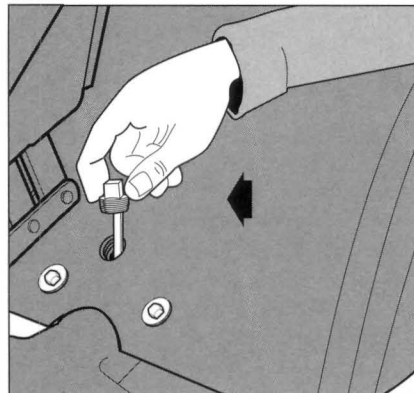

Figure 5-8: Remove dipstick with a 9/16" wrench to check gear oil level in tine attachment transmission. Markings on dipstick must face rear of tiller when checking oil level.

above ground. This elevation allows an accurate "cold" gear oil reading ("cold" means 2 hours has passed since the tiller was used).

4. Wait two hours with tiller elevated (allow more time if temperature is below 40°F).

5. Loosen and remove transmission dipstick (Fig. 5-8). Wipe it clean with a rag.

6. Hold dipstick so its markings face rear of tiller. Lower it straight down into the sump hole to touch the driveshaft inside (Fig. 5-8). Don't force or try to thread it back in...an incorrect reading will result.

7. Remove dipstick and check oil level. It should be anywhere within the cross-hatched area or even slightly above the "Max" marking. If correct, replace dipstick and remove the boards used as props.

8. If oil level was low, gear oil must be added before using the tiller. See "C. Adding or Changing Gear Oil" next.

For Dipsticks With Hot/Cold Markings:

1. Follow Steps 1 and 2 given for the other type of dipstick.

2. Put a 2"x4" board under the drag bar—raising the tiller and drag bar about 3-1/2" above ground. This elevation is for a "cold" reading which is preferable—2 or more hours since tiller was last used. (If taking a "hot" reading—tiller was operated for more than 30 minutes within the past hour, do not use the wood prop to elevate the tiller.)

4. Follow Steps 4, 5 and 6 given for the other dipstick type.

5. Remove dipstick and check level. It should be within or above the "Cold" range marking if taking a 'cold' reading. (If taking a "Hot" reading, the level should be within or slightly above the "Hot" range.)

6. If the level is incorrect, see Adding or Changing Gear Oil next.

Maintenance/Repairs

C. Adding or Changing Gear Oil

For *partial fill-ups* (a few ounces or less), use SAE 140, SAE 85W-140, or SAE 80W-90 weight gear oil with an API rating of GL-3, GL-4 or GL-5. For *full replacement*, use SAE 140 or SAE 85W-140 gear oil with an API rating of GL-4 only. (At the Factory, SAE 85W-140 weight gear oil is used.)

IMPORTANT – Do not use automatic transmission fluid or engine oil. They are too light in weight and will result in transmission damage.

The gear oil does not need to be changed. Do so only if you know, or suspect, it is contaminated with dirt, sand or other foreign particles.

Gear oil is available at well-stocked service stations, power equipment centers, or farm/heavy equipment outlets. (It may also be ordered from Troy-Bilt.)

Capacities: Power unit transmission holds approximately 60 ozs.; Tine Attachment transmission holds approximately 12-1/2 ounces.

To Add Gear Oil to the Power Unit Transmission:

1. Follow steps 1 and 2 of “To Check the Power Unit Oil Level:” on the previous page.
2. Using a 3/4" wrench (or socket), remove the bolt securing the handlebar base to the top of the transmission (prop the handlebars first to prevent them from falling).

Then, unplug the Forward Interlock wire harness receptacle at the bottom of the handlebars. Set the handlebar base and bolt aside on a clean surface. The bolt hole in the top of the transmission is the gear oil fill hole. See Figure 5-9.

3. Slowly pour gear oil through a clean funnel into the transmission. Stop when gear oil begins to flow from the oil level check hole on

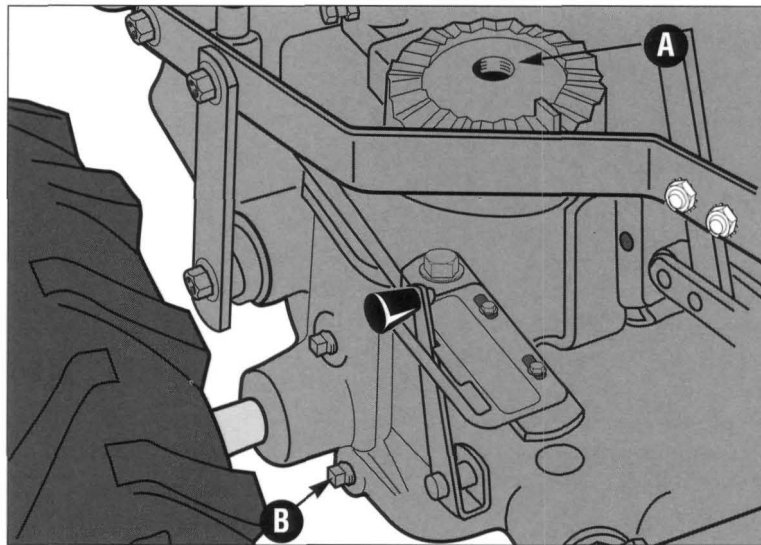

Figure 5-9: Gear oil fill hole (A) and gear oil drain location (B).

the left side of the transmission (Figure 5-7).

4. Reinstall the oil level check plug. Tighten it securely.
5. Reinstall the handlebars using the mounting bolt previously removed. Align the handlebars so they point straight backwards, not at an angle. Then tighten the mounting bolt securely.
6. Reconnect the Forward Interlock wire harness to the receptacle. Be certain it's secure.
7. Test operation of the Forward Interlock Safety System — refer to Section 4 for procedure.

To Drain and Fill the Power Unit Transmission:

1. Place a shallow pan under the transmission gear oil drain plug (refer to B, Figure 5-9).
2. Remove the oil level check plug (see Figure 5-7) with a 3/8" wrench. This vents the transmission for faster oil draining.
3. Using the 3/8" wrench, remove the drain plug (B, Figure 5-9). The gear oil will drain quite slowly since it is thick. After about two quarts have drained, tilt the tiller

forward so any oil at the rear of the transmission will drain out.

4. Clean the drain plug threads, put non-hardening gasket sealant on the threads, and reinstall plug.
5. Refill the transmission with the correct amount of gear oil before operating the tiller again. When oil seeps from the oil level check hole, the right amount of gear oil has been added. Replace all plugs.

To Add Gear Oil to the Tine Attachment Transmission:

1. Select the right depth regulator lever setting:
 - a) If filling an empty transmission, raise the Depth Regulator Lever so tines are on the ground.
 - b) If topping off the gear oil, move Depth Regulator Lever down to engage its top notch.
2. Remove dipstick from tine attachment (see Figure 5-8).
3. Slowly add gear oil in the dipstick hole. Add 1/2-ounce at a time to avoid overfilling. It takes about 12-1/2 ounces.
4. Take dipstick readings frequently. Stop when oil reaches “Cold” range marking on dipstick. Replace dipstick securely.

To Drain and Fill the Tine Attachment Transmission:

1. The tine attachment transmission is not equipped with an oil drain plug. To drain just a small amount of gear oil, remove the dipstick and tilt the attachment forward (first uncoupling it from the Power Unit).

2. For complete drainage, remove the left-side tine assembly (refer to Bolo Tine Maintenance for instructions), then remove just one of the lower screws from the tiller housing cover (Photo 5-10). To speed drainage, remove the tine attachment dipstick to vent transmission.

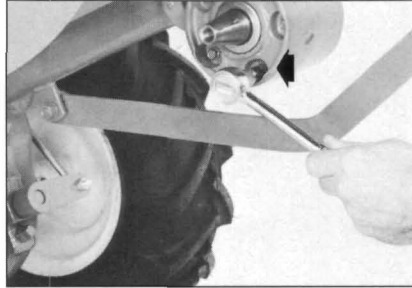

Photo 5-10: Remove housing cover screw to drain tine attachment transmission gear oil.

Note: If you find a plastic washer on the cover screw you remove, discard the washer. There is no need to install a replacement washer.

3. Once all gear oil has drained, reinstall the housing cover screw securely (first coat its threads with non-hardening gasket sealant).

4. Be certain to refill the transmission with the correct amount of gear oil before operating the tiller again.

DRIVE BELT MAINTENANCE



WARNING

To help avoid personal injury, stop the engine, wait for all moving parts to come to a complete stop, remove the electric start key, disconnect the spark plug wire and move the wire away from the spark plug, and let the engine and muffler cool before inspecting, adjusting or replacing the drive belt.

A. Measuring and Adjusting Drive Belt Tension

On a new tiller (or if a new belt is installed), the belt tension will probably need to be adjusted after the first two (2) hours of operation. Thereafter, check belt tension every ten (10) operating hours.

Maintaining the right tension is important to good tiller performance and long belt life. If too loose, the belt will slip on the pulleys, and be unable to deliver full power to the wheels and tines. A loose belt will also wear prematurely.

While checking belt tension, also inspect the belt for cuts, cracks, deterioration, etc. Don't continue using a belt that isn't in good shape. You're sacrificing tiller performance by doing so.

Tips on keeping the drive belt in top condition include:

- Always put the Wheels/Tines/PTO Drive Lever in NEUTRAL when the tiller is not in use.
- Keep tension adjusted correctly.
- Don't "speed shift" when moving the Wheels/Tines/PTO Drive Lever between FORWARD and REVERSE.

How to Measure Belt Tension:

1. Before taking a measurement, be sure the linkages and pivot points on the Wheels/Tines/PTO Drive Lever are clean and lubri-

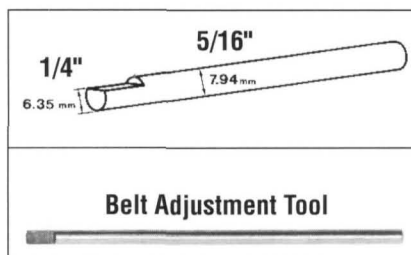

Photo 5-11: Use this belt adjustment tool to measure and adjust drive belt tension.

cated. If there is any binding, you won't get true measurements. Also, you'll need the belt adjustment tool you received with your new tiller (see Photo 5-11).

2. Move the Wheels/Tines/PTO Drive Lever fully down to the FORWARD position. The clutch roller at the bottom of the lever should be positioned underneath the belt adjustment block (Photo 5-12). Don't let the clutch roller move during the next few steps. If it moves, you'll get a false belt tension reading.

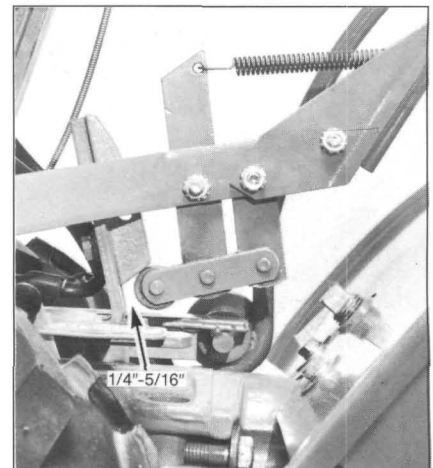

Photo 5-12: Shift into FORWARD and measure distance between roller and upright bracket using the belt adjustment tool.

Maintenance/Repairs

3. The belt tension is correct if the front of the clutch roller is 1/4"-to-5/16" away from the face of the upright bracket that holds the adjustment block in place (Photo 5-12). To measure this distance:

- a) Without moving the clutch roller, try inserting the 1/4"-thick, slotted end of the belt adjustment tool in between the roller and the upright bracket. (The flat edge of the tool must be facing the roller.) Refer to Photo 5-13.
- b) If only the *slotted* portion of the tool will fit, the belt tension is correct as is.
- c) If the slotted part of the tool will not fit in, the belt is too loose.
- d) If the full thickness (5/16") of the tool easily fits in, the belt is too tight.

4. If the belt tension is correct, move the Wheels/Tines/PTO Drive Lever back to NEUTRAL.

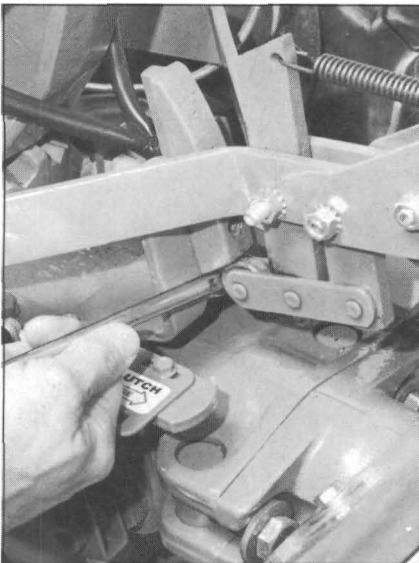

Photo 5-13: Insert slotted end of belt adjustment tool between roller and bracket, with the flat side of the slotted end facing the roller.

How to Adjust Belt Tension:

1. You adjust the drive belt tension by loosening the bolt securing the belt adjustment block, then moving the block up or down. Moving it down will tighten the belt; moving it up loosens the belt. (*Hint: the distance the block moves approximately equals the distance the roller moves.*) In most cases, the clutch roller will not have been very far out of position, so the adjustment block will only need to be moved slightly (up or down).

2. Move the Wheels/Tines/PTO Drive Lever to NEUTRAL position. The clutch roller will come to rest anywhere on the face of the belt adjustment block, depending upon drive belt length and current belt tension adjustment.

3. Insert the belt adjustment tool through the hole in the side of the adjustment block, spacing the ends of the tool equally on both sides (see Photo 5-14). Rotate the tool so the slotted end faces down.

4. Place the Wheels/Tines/PTO Drive Lever in FORWARD position. The arms of the clutch control yoke will be resting on the belt adjustment tool and the clutch roller should be engaged slightly beneath the adjustment block (see Photo 5-15).

5. Use one hand to hold the drive lever in FORWARD while using a 9/16" wrench to loosen (don't remove) the bolt at the back of the belt adjustment block (Photo 5-16). The adjustment block should be free to move either up or down.

6. Push the drive lever down if the belt needs tightening. Or pull the lever up if the belt needs to be loosened. Hold the drive lever in place and tighten the bolt in the adjustment block firmly.

7. Let go of the drive lever and remove the belt adjustment tool from the hole in the adjustment block.

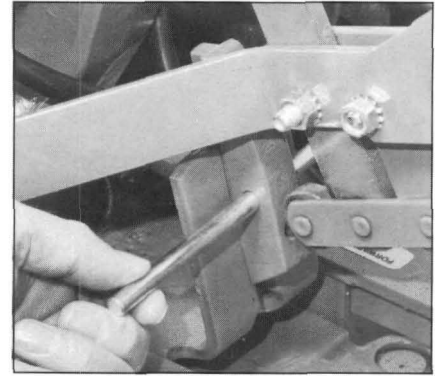

Photo 5-14: With Wheels/Tines/PTO Drive Lever in NEUTRAL, insert tool through hole in adjustment block.

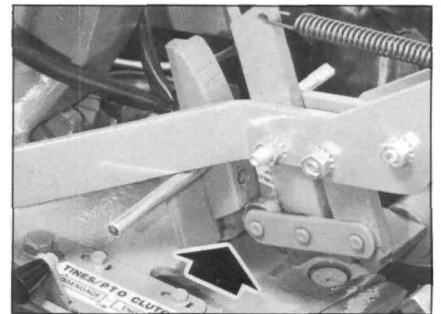

Photo 5-15: With Drive Lever in FORWARD position, clutch roller should be engaged slightly beneath the adjustment block.



Photo 5-16: Hold Drive Lever while loosening bolt. Push lever down to tighten belt; pull up to loosen belt.

8. Check the tension on the belt by following the previous instructions "How to Measure Belt Tension."

Note: If the adjustment block is all the way down and the measurement between the clutch roller and the bracket is less than 1/4", then a new drive belt is needed.

B. Replacing the Drive Belt



WARNING

To help avoid personal injury, stop the engine, remove the electric start key, disconnect the spark plug wire and move the wire away from the spark plug, and let the engine and muffler cool before removing or replacing the drive belt.

To Remove the Belt:

1. Move Wheels/Tines/PTO Drive Lever to NEUTRAL position.
2. While kneeling on the right side of the tiller, create slack in the belt by reaching over to the left side of the pulleys and pushing in on the center of the belt with your finger.
3. Use your right hand to move the belt down and away from the lower pulley, in the direction of the engine (Photo 5-17).



Photo 5-17: First move belt off the lower pulley.

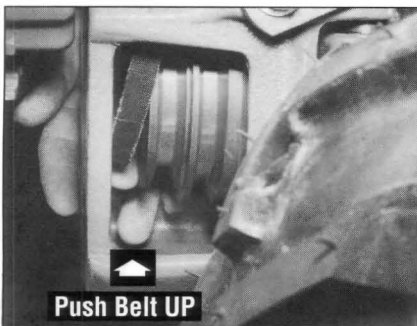

Photo 5-18: Push belt upward to create slack.

4. As shown in Photo 5-18, push the belt upward to create slack in the belt.

5. Lift the top half of the belt up and over the upper pulley and the rubber reverse disc, moving it in front of the reverse disc (refer to Photo 5-19).

6. Push the Wheels/Tines/PTO Drive Lever down into the FORWARD position. This increases the distance between the upper and lower pulleys. Next, lift and pull the entire belt out between the pulleys (Photo 5-20).

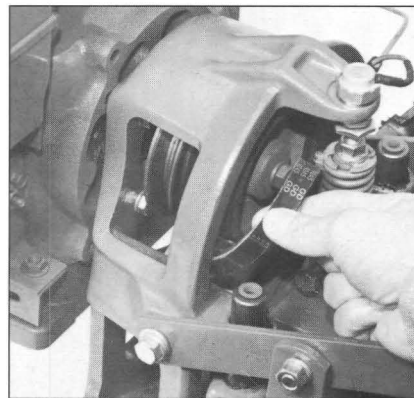

Photo 5-19: Move top half of belt over pulley and reverse disc.



Photo 5-20: Shift into FORWARD and remove the belt.

To Replace the Drive Belt:

1. Place Wheels/Tines/PTO Drive Lever in FORWARD position.
2. Squeeze the belt in the middle and insert one end in between the pulleys (see Photo 5-20).

3. Push belt forward then down until it is looped over the lower pulley (refer to Photo 5-18). Do not yet seat it in either of the lower pulley's grooves. (*Hint: a blunt object, like a ruler, can help you push the belt downward if needed.*)

4. Move the top half of the belt up and over the rubber reverse disc, but do not seat it in either of the grooves in the top pulley.

5. Place the Wheels/Tines/PTO Drive Lever in NEUTRAL.

6. Move the top half of the belt into the HIGH Range groove (groove closest to the engine) on the top pulley. See Photo 5-21.

7. Move the bottom half of the belt into the HIGH Range groove

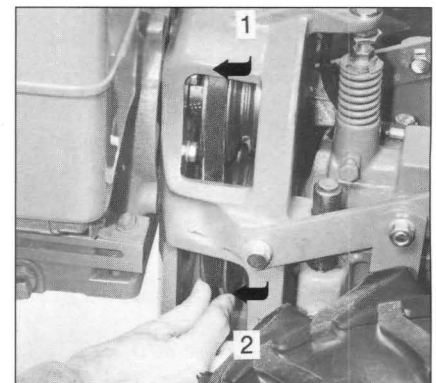

Photo 5-21: Seat belt in upper pulley, then in lower pulley ("High Range" position shown).

of the lower pulley (groove closest to engine). Photo 5-21. If extra slack is needed, hold up Wheels/Tines/PTO Drive Lever while moving the belt. Verify the belt is seated properly on the pulleys.

8. To move the belt to the LOW Range position, see "Changing Belt Speeds" in Section 4.

9. After installing the belt, check and adjust for correct belt tension as explained previously.

REVERSE DRIVE MAINTENANCE



WARNING

To help avoid personal injury, stop the engine, wait for all moving parts to come to a complete stop, remove the electric start key, disconnect the spark plug wire and move the wire away from the plug, and let the engine and muffler cool before inspecting, adjusting or replacing the reverse drive components.

These instructions explain how to inspect, replace or adjust the various reverse drive components.

But first, here's how the reverse drive system works: When you raise the Wheels/Tines/PTO Drive Lever up in REVERSE position, this lowers the rubberized reverse disc (it's attached to the engine drive pulley) until this rotating disc contacts the transmission drive pulley. The friction between the rotating reverse disc and the trans-

mission pulley causes the transmission drive shaft to be powered in a counterclockwise direction (as viewed from the operator's position behind handlebars). The drive shaft then turns the wheels and tine shafts in a reverse direction.

A. Reverse Disc Inspection

The reverse disc is made of steel with a special, long-lasting rubber

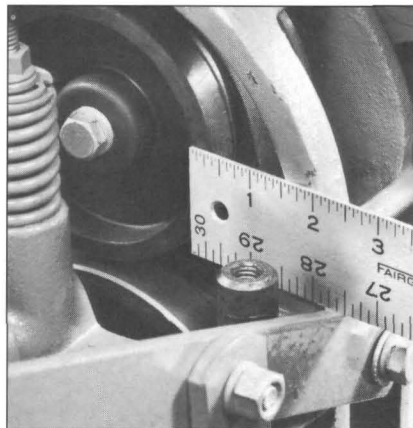

Photo 5-22: Measure the edge of the reverse disc for wear.

compound bonded to the disc rim. Since this is a wearing part, it should be inspected after every 30 operating hours.

1. Measure the width of the outside edge of the disc as shown in Photo 5-22. Replace the disc before the rubber edge wears to a thickness of 1/8" or less. Failure to do so could cause the steel underneath the rubber to damage the transmission pulley.

2. Look for big cracks or missing chunks of rubber from the disc. If so damaged, the disc should be replaced immediately.

IMPORTANT – Extend the life of the reverse disc by always pausing in NEUTRAL before shifting between FORWARD and REVERSE. Also – the reverse disc is not suited for continuous or sustained reverse operation. Use reverse sparingly.

B. Replacing the Reverse Disc

Follow these steps to replace the reverse disc. (If your tiller has a Bumper Attachment mounted, it must be removed first.)

To Remove the Reverse Disc:

1. Move Wheels/Tines/PTO Drive Lever in NEUTRAL position.
2. Wedge a 5/16"-thick board between the top of the engine pulley (avoid contacting the reverse disc) and the cast iron housing next to it. This "freezes" the pulley.
3. Use a 9/16" wrench to loosen the mounting bolt shown in Figure 5-23. Remember to freeze the pulley with the wood wedge while loosening the bolt. If necessary, separate the disc from the pulley with the tip of a screwdriver. Back

the bolt out as far as possible. Then angle the disc a little to remove it. Bring the bolt and lock-washer along with the disc.

To Install a New Reverse Disc:

Just reverse steps 1-through-3 described previously. Tighten the mounting bolt securely, and check for correct operation — see next page for checking instructions.

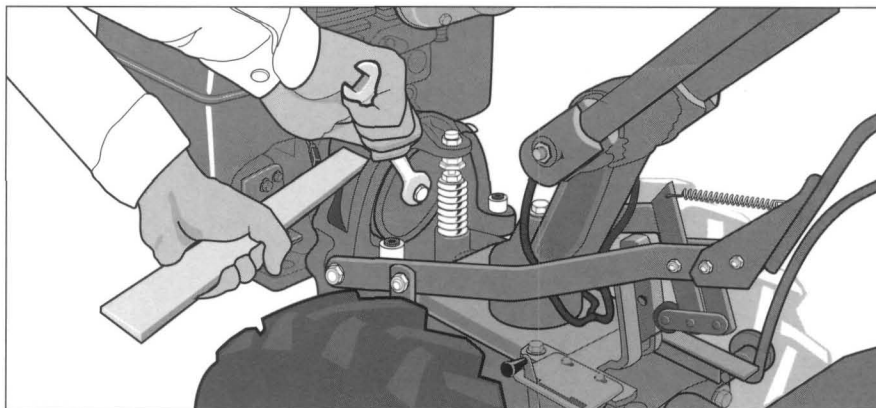

Figure 5-23: Immobilize the pulley with a wood wedge, then loosen the bolt so you can remove the rubber reverse disc. (The disc may need to be pried away from the pulley.)

C. Checking and Adjusting the Reverse Drive System



WARNING

To help avoid personal injury, stop the engine, remove the electric start key, disconnect the spark plug wire and move the wire away from the plug, and let the engine and muffler cool down before inspecting or adjusting the reverse drive parts.

When the Wheels/Tines/PTO Drive Lever is moved up into REVERSE, the engine and engine mount move down to press on the reverse adjustment bolt (see Photo 5-24). This action compresses the reverse spring and plunger assembly, requiring you to hold the lever up in REVERSE. When you release the lever, the spring automatically pushes the lever back into NEUTRAL position.

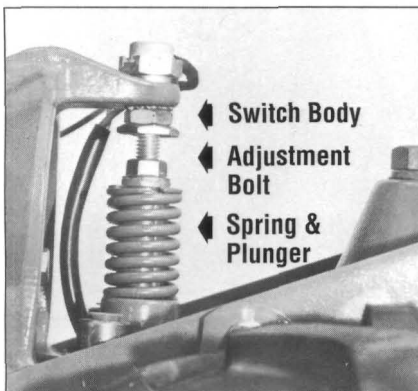

Photo 5-24: Spring and plunger assembly.

The spring and plunger assembly is designed to prevent the reverse disc from making contact with the transmission pulley until you shift into REVERSE. When the lever is in NEUTRAL, the switch body on the bottom of the engine mount tab should be resting squarely on top of the reverse adjustment bolt (Photo 5-24). The reverse adjustment bolt can be adjusted up or down to correct a

number of reverse drive operating problems, as explained next.

Check Action of Reverse Disc:

1. Verify that the linkages for the Wheels/Tines/PTO Drive Lever are lubricated with oil and the engine mount bars and the belt adjustment block are lubricated with grease. (See "Tiller Lubrication" in this section.)
2. Place the Wheels/Tines/PTO Drive Lever in NEUTRAL. Briefly pull out the engine recoil start rope while watching the reverse disc. The disc should turn, but the lower pulley should not (refer to Photo 5-25). If the reverse disc turns the lower pulley, or if it is located closer than 3/16" to the pulley, the reverse adjustment bolt should be adjusted upward (see instructions that follow). Moving the adjustment bolt upward will also solve the problem of

a tiller that goes into REVERSE on its own.

3. Use your left hand to hold the Wheels/Tines/PTO Drive Lever up in REVERSE, while briefly pulling out the engine start rope. The reverse disc should turn the lower pulley (see Photo 5-26). If not, or it requires a lot of pressure to hold the lever up in REVERSE, then the reverse adjustment bolt must be adjusted downward. When correctly adjusted, the Wheels/Tines/PTO Drive Lever should "pop" out of reverse when the lever is released, but not require exceptional effort to hold it up in the reverse position.

4. Shift the Wheels/Tines/PTO Drive Lever to REVERSE and then let it go. The lever should return to NEUTRAL. If not, the reverse adjustment bolt will have to be adjusted upward.

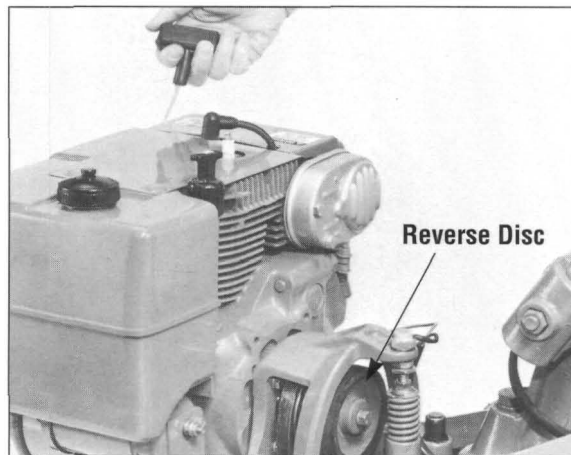

Photo 5-25: With shift lever in NEUTRAL, only the reverse disc should turn when starter rope is pulled out.

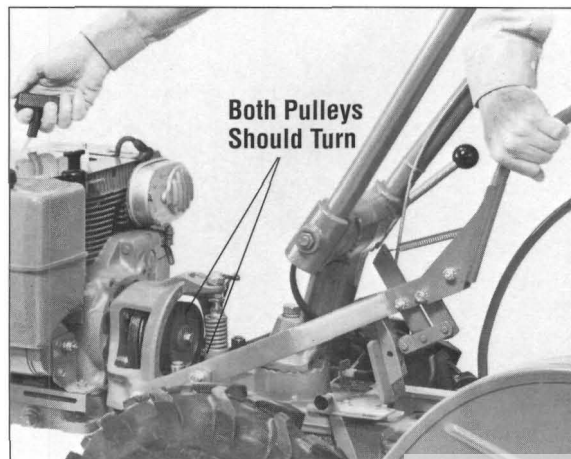

Photo 5-26: With shift lever in REVERSE, the reverse disc should turn the transmission pulley when the starter rope is pulled out.

Maintenance/Repairs

Adjusting Reverse Drive:

1. Place Wheels/Tines/PTO Drive Lever in FORWARD position.
2. On left side of tiller, put a 1/2" wrench on the plunger retaining bolt and another 1/2" wrench on the jam nut next to it (Photo 5-27). While holding the bolt steady, loosen the jam nut (counterclockwise) until it touches the bolt head.

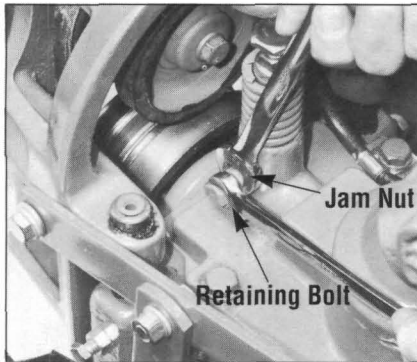

Photo 5-27: Hold bolt steady while loosening or tightening jam nut.

3. Turn the bolt in until it tightens against the plunger inside the spring. The bolt must be tight to prevent plunger from turning – but be careful not to overtighten and break the bolt.
4. Place a 7/8" wrench on the head of the reverse adjustment bolt and a 9/16" wrench on the jam nut below it (see Photo 5-28). Hold

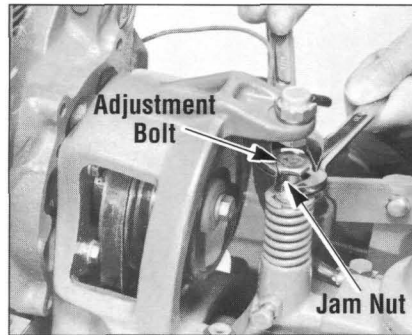

Photo 5-28: Loosen jam nut before turning reverse adjustment bolt.

the bolt steady while loosening the jam nut three or four turns.

5. Move the Wheels/Tines/PTO Drive Lever to NEUTRAL. The switch body on the bottom of the engine mount tab (see Photo 5-24) should be resting squarely on top of the reverse adjustment bolt, and the reverse disc should be at least 3/16" away from the transmission drive pulley. If the reverse disc is any closer than this, raise the reverse adjustment bolt (turn it counterclockwise).
6. Check that the reverse disc is at least 3/16" away from the transmission drive pulley. Then hold the reverse adjustment bolt steady with one wrench while tightening the jam nut with a second wrench (see Photo 5-28).

7. Place a chalk or pencil mark on the top edge of the plunger retaining bolt. Now, while watching the mark, loosen the bolt 3/4-turn (see Photo 5-29). Do not exceed a 3/4 turn (this would disengage the bolt from the locking groove in the side of the plunger).

8. Hold the plunger retaining bolt steady with a wrench while tightening the jam nut against the side of the plunger housing (Photo 5-27).

9. Check the action of the reverse disc as explained previously.

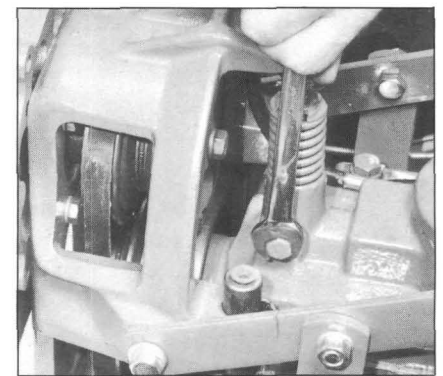

Photo 5-29: Loosen plunger retaining bolt about 3/4-turn, then tighten jam nut against plunger housing.

IMPORTANT – If the above adjustments have not corrected an improperly working reverse drive, please contact our Technical Service Dept. for assistance.

BOLO TINE MAINTENANCE



WARNING

To help avoid personal injury, stop the engine, wait for all moving parts to come to a complete stop, remove the electric start key, disconnect the spark plug wire and move the wire away from the spark plug, and let the engine and muffler cool before inspecting, removing or replacing the tines or tine holders.

A. Checking Tines for Wear

Inspect the tines for wear or damage after every 30 operating hours. The rate of wear depends upon hours of use and soil conditions. With use, the tines get shorter, narrower and more pointed (see Photo 5-30). If badly worn, they lose the ability to till deeply. Also, worn tines leave an ever-increasing "gap" in the middle of a tilled row. The normal gap is 3" between the tine tips – replace the tines when the gap widens to 5".

Tines can be replaced individually or as a complete set. See replacement instructions that follow.



Photo 5-30: Check for tine wear every 30 operating hours.

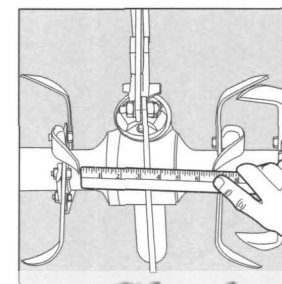

Figure 5-31: Replace tines when the gap between inner tines is 5" or more. (Normal gap is 3".)

B. Single Tine Replacement



WARNING

The tines or tine hood edges may be sharp. Wear thick gloves to protect your hands from cuts or scrapes.

1. Move the Wheels/Tines/PTO Drive Lever to NEUTRAL, the Wheel Speed Lever to either FAST or SLOW position, and the Tines/PTO Clutch Lever to ENGAGE.
2. Gently tilt the tiller forward until the engine rests on the ground.

3. Raise the hood flap at the back of the tiller and tie it up with string.

4. Before removing a tine, note in which direction the bent tip points. The new tine must be installed in the same direction.

5. Use two 9/16" wrenches to remove the two bolts and nuts securing the tine to the tine holder plate (see Photo 5-32). Use penetrating oil on the hardware if it is rusted or hard to remove.

6. Mount the new tine exactly the way the old tine was positioned. (The sharp edge of the tine, which

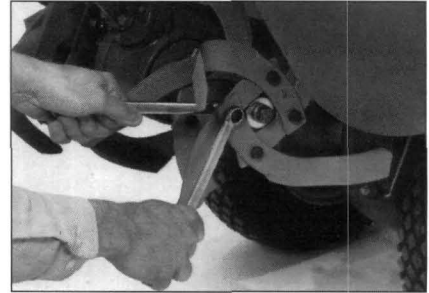

Photo 5-32: Removing a single tine requires taking off two bolts and two nuts.

enters the soil first, must face forward when above the tine shaft.) Replace the bolts and nuts and tighten them securely.

C. Removing and Replacing the Tine Holders



WARNING

The tines or tine hood edges may be sharp. Wear thick gloves to protect your hands.

The 16 Bolo Tines are mounted eight per side on left-side and right-side tine holders – on either Style A or Style B holders (refer to Figures 5-33A and 5-33B to see which style tine holder you have). Style “A” tine holders are secured to the tine shaft with two bolts and two nuts. Style “B” tine holders are secured with a single end bolt to the left and right sides of the tine shaft. Here’s how to replace the tines and holders as assemblies.

Removal Steps:

1. Follow steps 1-through-3 in “Single Tine Replacement” above.
2. Identify the tine holders as Style A or Style B, then as left-side and right-side holders – they must be replaced on the same side from which they were removed. Use a piece of chalk or a grease pencil to mark them “L” and “R.”
3. With Style A holders, remove the two bolts and nuts securing each holder (Fig. 5-33A). With Style B holders, remove the single bolt (along with the washers) from

the very end of the tine shaft (Fig. 5-33B).

4. Use a soft mallet to drive the holder off the tine shaft. (Use a heavy hammer and block of wood to drive off a “frozen” tine holder.)
5. When the holder is off, clean all dirt and debris from the shaft and the holder. Apply fresh grease to the tine shaft.

Replacement Steps:

1. Replace the holder so the sharp tine edges face forward (toward front of tiller). Tap tine holder back on the tine shaft.
2. Grease the threads on the mounting bolt(s). Install and tighten the bolt(s) securely.



WARNING

Wear safety goggles to protect your eyes. When loosening hardware, do not hit a wrench with a metal tool—this could shatter the tool or wrench, sending metal particles into your eyes.

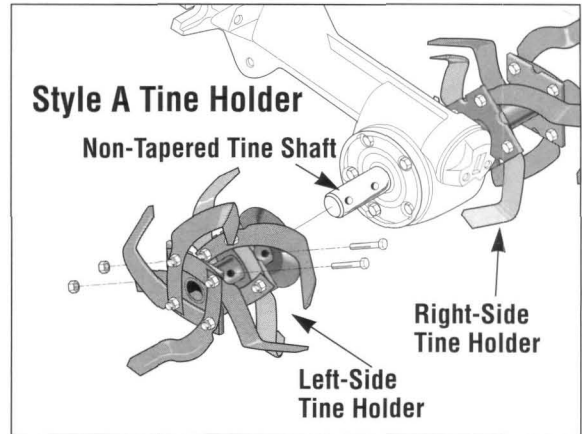

Figure 5-33A: Style “A” Tine Holders— Left and right-side tine holders are secured to the tine shaft with two bolts and two nuts.

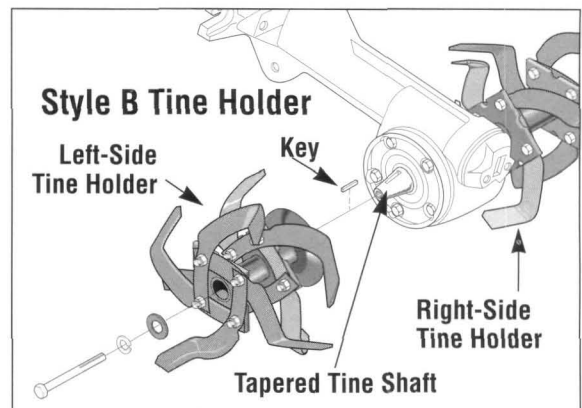

Figure 5-33B: Style “B” Tine Holders— Left and right-side tine holders are each secured with a single mounting bolt into the end of the tine shaft.

Maintenance/Repairs

TINE SHAFT MAINTENANCE

After every 10 operating hours, remove the left- and right-side Bolo Tine holders and clear away dirt and debris that have accumu-

lated on the tine shaft or inside the tine holders. Please follow this maintenance recommendation, as debris can cause premature wear to the tine shaft and its oil seals. Refer to the previous tine holder

removal instructions (see previous page). After cleaning away any debris and removing old grease from the tine shaft, apply fresh grease to the tine shaft.

TIRE AND WHEEL MAINTENANCE

Check tire air pressure every 30 operating hours. The recommended pressure for tilling is 10-to-20 psi (pounds per square inch). Both tires should be inflated equally. (Unequal pressure can cause the tiller to pull to one side.)



WARNING

To help avoid personal injury, stop the engine, wait for all moving parts to come to a complete stop, remove the electric start key, disconnect the spark plug wire and move the wire away from the spark plug, and let the engine and muffler cool before removing or replacing the wheels.

Removing the Wheels

Each wheel is secured by a roll (spirol) pin that passes through the

wheel hub and the wheel shaft. Drive the roll pin out to remove a wheel.

1. Prop the transmission up with a sturdy block to raise the wheel you want to remove off the ground.
2. Move the Wheel Speed Lever to either SLOW or FAST position to prevent the wheels from turning.
3. Use a 5/16" drift pin (or a blunt point 16-penny nail) to drive the roll pin free. See Photo 5-34.



WARNING

Wear safety goggles when driving the roll pin into or from the wheel hub to protect your eyes from the possibility of flying metal particles.

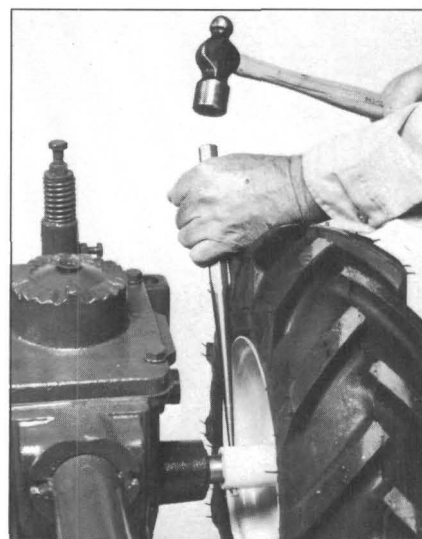

Photo 5-34: Drive roll pin out to remove wheel. Grease wheel shaft before replacing wheel.

ENGINE OIL MAINTENANCE

Change engine oil after first five (5) hours of new operation. Thereafter, change the oil every ten (10) operating hours. This may be more often than your engine manufacturer literature recommends, however your tiller may be operating in dirty or very dusty conditions.

Follow the engine manufacturer's literature for specific oil changing procedures, quantity of oil, and particular grade and viscosity of oil to use in your engine. Locations to check the oil level and to drain the oil are shown at right. Note that there are two oil fill plugs (one on each side) on the Briggs & Stratton engines.

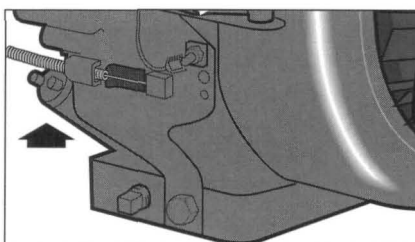

Figure 5-35: Oil fill plug on 7HP Briggs & Stratton engine.

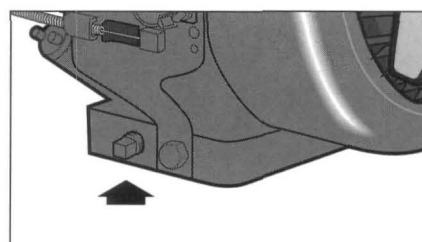

Figure 5-37: Oil drain plug on 7HP Briggs & Stratton engine.

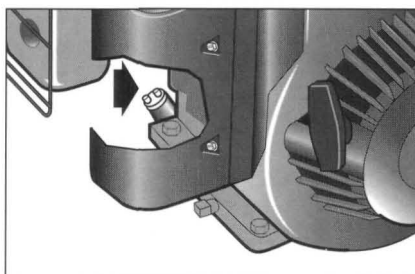

Figure 5-36: Oil fill plug on 8HP IP Briggs & Stratton engine.

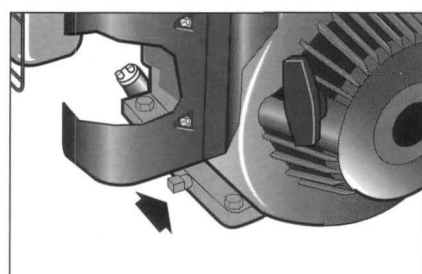

Figure 5-38: Oil drain plug on 8HP IP Briggs & Stratton engine.

AIR CLEANER MAINTENANCE

The engine is equipped with a dual element air cleaner that filters the air twice before it enters the carburetor to mix with the fuel.

It is critical that the filters be kept clean and properly installed at all times. See the location of the air cleaner assembly on your engine by referring to Figure 5-39 or Figure 5-40.

Refer to the engine manufacturer's literature supplied with your tiller for complete air cleaner service and maintenance information.

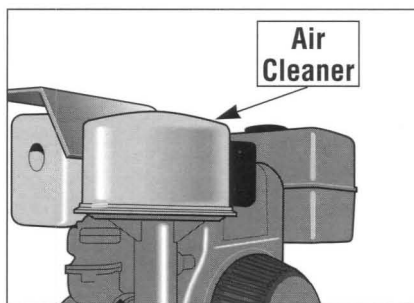

Figure 5-39: Air cleaner on the 7HP Briggs & Stratton engine.

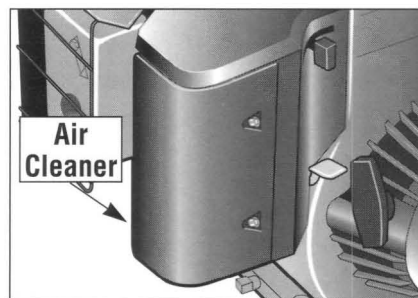

Figure 5-40: Air cleaner on the 8HP IP Briggs & Stratton engine.

THROTTLE CABLE MAINTENANCE



WARNING

To help avoid personal injury, stop the engine, wait for all moving parts to come to a complete stop, remove the electric start key, disconnect the spark plug wire and move the wire away from the spark plug, and let the engine and muffler cool before adjusting the throttle cable.

The throttle lever settings are factory-adjusted, so unnecessary adjustments should not be made. However, if the engine does not start or stop, or respond immediately to various throttle lever settings, then adjustments may be necessary. Please refer to the engine manufacturer literature supplied with your tiller for specific adjustment instructions.

Of course, you may contact your nearest authorized engine service dealer for throttle cable ad-

justments by a qualified service representative.

IGNITION SYSTEM MAINTENANCE

Your engine is equipped with electronic ignition. It does not have a condenser or points, so there is no need to perform any regular "tune-up" maintenance on this system other than adjusting or replacing the spark plug.

SPARK PLUG MAINTENANCE

The spark plug (see Figure 5-41) must be in good condition for proper engine operation. Remove and inspect the plug every 50 operating hours or annually, whichever occurs first.

The correct electrode gap for the Briggs & Stratton engine is .030". Check the gap with a feeler gauge. Do not use a spark plug if the porcelain is cracked, the electrodes are pitted or burned, or if other visible damage is present. **Note:** Do not wire brush or sandblast the spark plug to clean it – loose particles can enter the engine, causing damage!

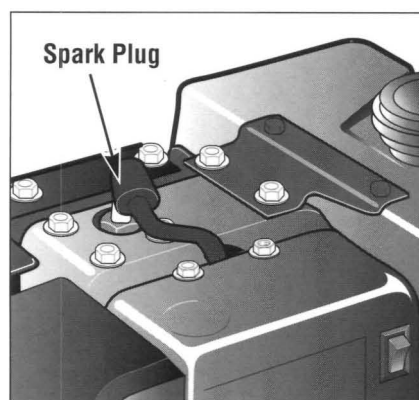

Figure 5-41: Spark plug (with boot on) is on the top of the engine (8HP IP engine shown).

To replace the plug, first tighten it securely by hand, then use a spark plug wrench to tighten the plug an extra 1/4 turn.

BATTERY CARE AND MAINTENANCE



DANGER

POISON—CAUSES SEVERE BURNS

- Electrolyte is a sulfuric acid solution.
- Avoid contact with skin, eyes and clothing.
- To prevent accidents, wear protective clothing, rubber gloves, and shield eyes with safety goggles.
- Neutralize acid spills with baking soda and water solution. Neutralize empty container with baking soda and rinse with water.

ANTIDOTE: External— Flush with water. Eyes— Flush with water for 15 minutes and get prompt medical attention.

ANTIDOTE: Internal— Drink large quantities of water or milk. Follow with milk of magnesia, beaten eggs or vegetable oil. Call physician immediately.

KEEP OUT OF REACH OF CHILDREN

DANGER — BATTERIES PRODUCE EXPLOSIVE GASES

- Keep sparks, flame, cigarettes away at all times.
- Only charge or use the battery in a well-ventilated area.
- Make sure venting path (vent tube) of battery is always open.



DANGER

Never touch the positive (+) battery post and any other surrounding metal with tools, jewelry, or other metal objects. Doing so can cause a short circuit that could result in electrical burns, an electrical shock, or explosion of battery gas.

A. Battery Care in Service

1. Every month or every ten (10) operating hours, whichever comes first, check the level of electrolyte solution in the battery cells:

- a) If the battery case has UPPER and LOWER level lines on it, the solution should be maintained at the UPPER level line.
- b) If the battery does not have level lines on the case, maintain the solution level at the lowest part of the filler well within each cell. See Figure 5-43.

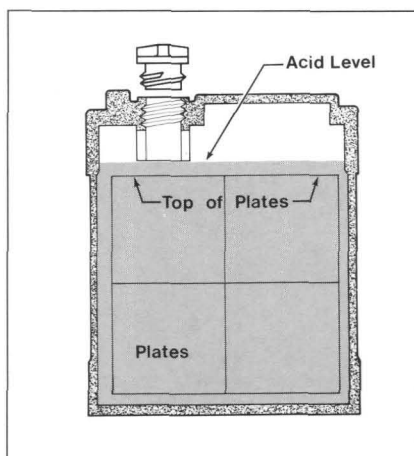

Figure 5-43: Keep battery cells filled up so the solution reaches the bottom of each filler well.

Only use distilled or demineralized water to refill each battery cell. After filling, replace the battery caps securely, then wash off any spilled solution with a baking soda and water mixture. Next, run the engine outdoors for about 20 minutes (at 3/4 throttle) to help recharge and recirculate the electrolyte solution. For safety, do not leave the tiller unattended while the engine is running.

2. Keep the battery clean. If terminals are corroded, remove battery and clean terminals with a wire brush, sandpaper or steel wool. (Avoid getting any of this corrosive material on your skin or in your eyes.) Rinse battery with a solution of baking soda and water. Coat the terminals with petroleum

jelly or silicone grease to prevent further corrosion.

3. Periodically check entire electrical system for loose connections or loose hardware.

4. Check hardware securing the battery holddown clamp. It should be secure, but not overly tight.

5. Check the vent tube. It must not be crimped or bent.



WARNING

To help avoid personal injury, be sure the battery vent tube is not crimped or pinched anywhere along its length. Improper venting could result in an explosion of battery gases.

B. Battery Care in Storage

Your engine has a recharging circuit that will properly maintain the battery's state of charge during the normal tilling season.

However, prior to storing your tiller away during the off-season, we recommend the battery be fully charged. At the end of the storage period, the battery should be recharged again.



DANGER

• While the battery is being charged, do not leave it unattended. Charging time does not have to be continuous.

• Carefully follow all charging instructions and safety rules provided by the manufacturer of the charging equipment.

• Never attempt to "jump start" the battery with an automobile battery or its charging system. This could result in serious personal injury or property damage from causes such as a battery explosion, or acid or electrical burns.

1. Remove the battery from the tiller (see "Battery Removal" instructions on this page) and place on a stable, level surface.
2. Clean the battery if needed. If the battery is very cold, let it warm up to between 60-to-80°F.
3. **Remove filler caps. Keep them off when filling and charging.**
4. Carefully check the electrolyte level. If low, add distilled or demineralized water (**do not add battery acid**) to bring the solution level in each cell up to the correct height. Avoid overfilling.
5. Charge the battery (with caps removed) until all cells are gassing freely. (To check for gassing, wear protective goggles and inspect each cell with a flashlight for bubbling of the electrolyte solution.) Use one of the following methods to charge the battery:
 - a) Recommended Method: charge the battery at a rate of 1-to-2 amperes until cells are gassing freely. Do not exceed 24 hours charging time.
 - b) First Alternative Method: charge battery at 4-to-6 amperes until cells gas freely. Do not exceed 8 hours charging time.
 - c) Second Alternative Method: charge the battery at a rate of 6-to-12 amperes until cells gas freely. Do not exceed 4 hours charging time.



CAUTION

Do not charge the battery at a rate higher than 12 amperes. A charge rate greater than this generates excessive heat and gassing, and will permanently damage the battery.

6. When battery is fully charged, turn charging equipment off and disconnect the cables. Check electrolyte level in all cells. Add distilled or demineralized water if

necessary to adjust level to the correct height. Then reconnect the charger cables to the battery and charge the battery for one more hour.

7. Replace the filler caps and wash off any spilled electrolyte with a baking soda and water solution.
8. Store the battery in a cool, dry location. Avoid freezing temperatures. Batteries lose voltage when in storage, more so in hot weather than in cold. Ideal storage temperature is 50°F.

C. Battery Removal and Replacement



WARNING

To help avoid personal injury, stop the engine, wait for all moving parts to come to a complete stop, remove the electric start key, disconnect the spark plug wire and move wire away from spark plug, and let the engine and muffler cool before removing or replacing the battery.

1. Disconnect the negative (-) cable from the grounding screw on the right side of the battery bracket

(A, Photo 5-44) and bend the cable away from all metal parts.

2. Disconnect the negative cable from the negative (-) battery post (B, Photo 5-44), and remove cable.
3. Disconnect positive (+) cable from positive battery post (C, Photo 5-44) and bend it safely away from metal parts. Cover cable terminal with rubber boot.
4. Remove the battery holddown clamp and remove the battery.
5. Reverse the previous steps to replace the battery. **The battery posts must face the rear of the tiller.** (The positive post must be on the left side as you face forward from the handlebars.)
6. Insert the vent tube (on positive side of battery) into the vent tube shield. Be sure it is not crimped, pinched or folded along its length.



WARNING

When removing the battery, always disconnect the negative (-) cable first followed by the positive (+) cable. Reverse this procedure when re-installing the battery.

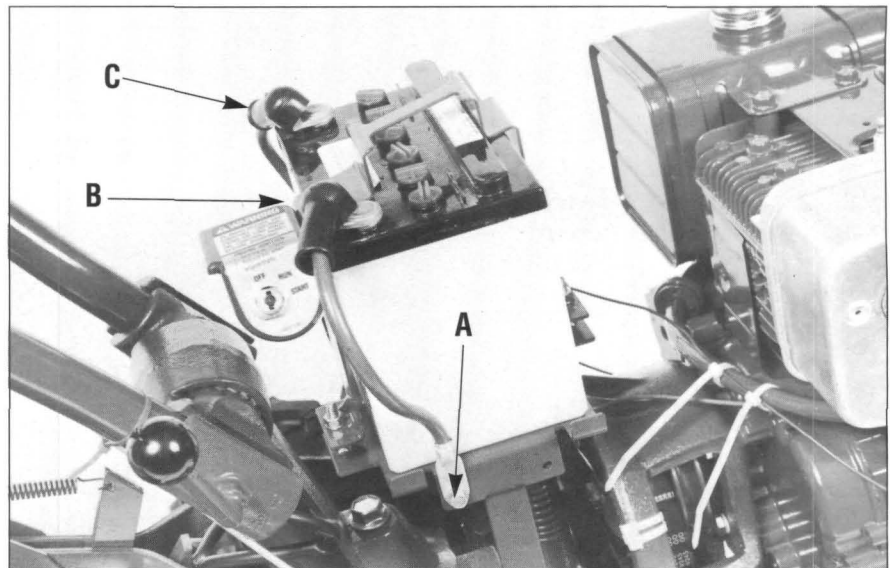

Photo 5-44: Follow battery removal and replacement instructions carefully.

Maintenance/Repairs

STORING YOUR TILLER

When your tiller won't be used during the off-season, prepare it for storage with the following steps:

1. Clean the tiller and engine.
2. Do routine tiller lubrication and check for loose hardware.
3. Protect the engine from deterioration or damage by referring to the engine storage instructions in your engine manual literature.

4. When engine is still warm, drain oil from engine crankcase. Refill with fresh motor oil.

5. Protect the internal cylinder against rust by removing the spark plug and pouring one ounce of clean engine oil into the spark plug hole. Then slowly pull out the re-coil start rope 2 or 3 times to distribute the oil internally. Replace the spark plug, but do not reconnect the plug wire. Pull the rope until resistance is felt — let rope rewind. The valves are seated.

6. Charge the battery (if your tiller has the electric start option). Store battery in a cool, dry location.

7. Move Wheels/Tines/PTO Drive Lever to NEUTRAL position. Keep tiller in a clean, dry area.

8. Never store tiller with fuel in fuel tank in an *enclosed* area where gas fumes could reach an open flame or spark, or where ignition sources are present (space heaters, hot water heaters, furnaces, etc.).

INSPECT FORWARD INTERLOCK WIRING SYSTEM

Every ten (10) operating hours, check the Forward Interlock wiring system for tight connections and to see that the insulation on the wires is unbroken (to prevent the system from shorting out).

1. Check the insulated wire harness leading from the lower ends

of the handlebars over to the wire harness connector on the top, right side of the transmission cover (Photo 5-47). Be sure the connector is securely mated.

2. Check the insulated tubing leading from the connector to the cast iron motor mount/belt shroud.

3. Check the wire leading from the tubing over to the switch assembly mounted on top of the tab on the cast iron motor mount—belt shroud (see Photo 5-45). Also check the second wire that leads to the throttle cable mounting bracket on the right side, forward portion of the engine.

TROUBLESHOOTING THE FORWARD INTERLOCK SAFETY SYSTEM

The wiring circuit for the Forward Interlock Safety System is designed to ground out the engine's ignition system.

There are three switches in the circuit which, when open, let the engine run. One switch is on the neutral plunger tab of the cast iron motor mount (see Photo 5-45). This switch is open whenever the Wheels/Tines/PTO Drive Lever is in NEUTRAL or REVERSE positions. The other two switches are located inside the handlebars, directly above the two Forward Interlock Levers (see Photo 5-46). The switches are wired in series, so when any are opened (by squeezing one of the Forward Interlock Levers), the engine will run. There is a fourth switch located in the wiring harness connector.

tor on the top, right side of the transmission cover (Photo 5-47). It warns you if the connection is not mated by not letting the engine run while the Wheels/Tines/PTO Drive Lever is in FORWARD.

Only a few things can go wrong with this circuit:

1. A broken or disconnected wire could let the engine run without you having to press one of the Forward Interlock Levers.

2. A bare wire touching tiller or engine metal could ground out the engine's ignition.

3. A switch that has failed may act as an open switch and allow the engine to run. Or it may act as a ground and prevent the engine from running.

Refer to the Troubleshooting pages at the end of this Manual if your Forward Interlock Safety System is not operating correctly.

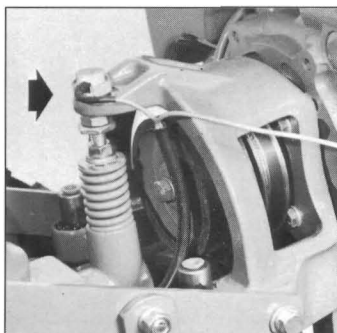

Photo 5-45: Neutral plunger switch.

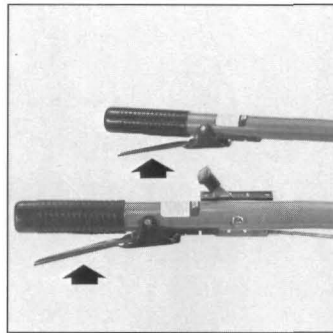

Photo 5-46: Forward Interlock Levers.



Photo 5-47: Wiring harness connector.

CHECK OR TEST (Check or test in sequence shown until problem is resolved.)	PROBLEM		
	Engine won't start	Engine shuts off when Wheels/Tines/PTO Drive Lever is shifted into Forward	Engine does not shut off when Forward Interlock Levers are released while Wheels/Tines/PTO Drive Lever is in Forward
Throttle Lever in START position	X		
Wheels/Tines/PTO Drive Lever in NEUTRAL position	X		
Forward Interlock Wire Harness connector securely mated		X	X
Forward Interlock Levers not being squeezed prior to shifting Wheels/Tines/PTO Drive Lever to FORWARD position		X	
Visually inspect for bare, broken or disconnected wires	X		X
Check handlebar wire harness	X		X
Check transmission wire harness	X		X

TROUBLESHOOTING PROCEDURES

The following pages list possible problems (each one is numbered) that you might encounter with the tiller or its engine. After the problem, we list possible solutions, along with a reference location if appropriate. If you have a problem not listed here, or find that a solution doesn't work, contact us for further assistance, or contact your local TROY-BILT Dealer or an Authorized Engine Service Dealer.

1 *Wheels/Tines/PTO Drive Lever:*

A. Lever does not stay in FORWARD–

- Drive belt may be too tight. Raise belt adjustment block a little. See Section 5.
- Clutch pawl spring at end of lever may be overstretched. Install new spring.

B. Lever hard to shift into REVERSE–

- Check reverse disc for wear. See Section 5.
- Check adjustment of reverse disc and/or reverse spring and plunger assembly. See Section 5.

- Clean and re-lubricate motor mount bars, belt adjustment block and linkages on lever. See Section 5.

C. Tiller stays in REVERSE when lever is released–

- Lubricate motor mount bars, belt adjustment block and linkages on lever. See Section 5.
- Check adjustment of reverse spring and plunger. See Section 5. If problem persists, contact Technical Service Department.

D. Lever sticks in FORWARD–

- Lubricate motor mount bars, belt adjustment block, and linkages on lever.



WARNING

To help avoid personal injury, stop the engine, wait for all moving parts to come to a full stop, remove the electric start key, disconnect spark plug wire and move the wire away from the spark plug, and let the engine and muffler cool before performing any trouble-shooting checks.

See Section 5. If problem continues, contact the Technical Service Department.

E. Lever hard to shift into FORWARD–

- Follow advice for Problem 1-D. Also check for possible bent motor mount bar that could be binding in engine mount holes.

2 *Wheel Speed Lever:*

A. Lever hard to shift, or sticks in FAST or SLOW wheel gear positions–

- Lubricate eccentric lever at rear of power unit transmission. See Photo 5-48. If rust is present, use penetrating

Troubleshooting

oil and work eccentric lever back and forth by hand.

- Lubricate linkage that connects Wheel Speed Lever to eccentric lever. Photo 5-48.
- Clutch inside transmission may be binding. Disconnect linkage from eccentric lever and work eccentric lever by hand. If difficult or impossible to move, it may be due to a damaged keyway on the wheel shaft. Contact Technical Service Dept.
- Lubricate washers and castle nut on pivot of lever. If necessary, remove roll pin and back nut off 1/6th turn. Replace roll pin and test the movement.
- Apply grease to zerk fitting (if so equipped) with grease gun until grease appears around washers.

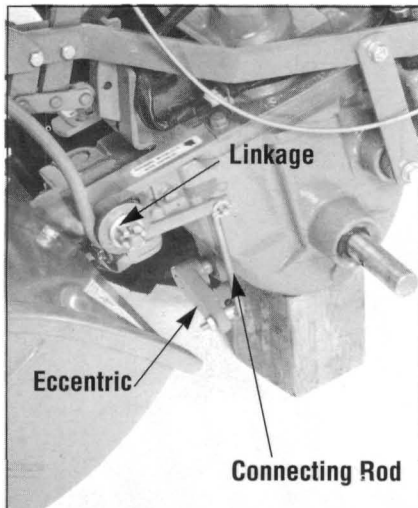

Photo 5-48: Check connecting rod, shifting linkage and eccentric lever.

B. Lever shifts into FAST wheel gear, but not into SLOW wheel gear—

- Connecting rod at end of lever might be backwards, or bent in toward transmission housing and hitting it. Other shifting linkage might be bent. Straighten or replace linkage. See Photo 5-48.
- Clutch inside transmission may be binding. See Problem 2-A.

C. Lever moves freely, but won't shift in or out of gear—

- Eccentric shifting pin inside transmission may be broken (rare) or worn. Disconnect linkage from eccentric lever and try moving eccentric lever by hand.

See Photo 5-48. If lever moves easily, contact the Technical Service Department.

3 Wheels and Tines Won't Turn:

- Review operation of controls. See Sections 3 and 4.
- Check condition and adjustment of drive belt and reverse disc. See Section 5.
- Mounting bolt for transmission drive pulley may be loose. (See Photo 5-1). If so, drive belt or reverse disc will turn pulley, but pulley won't turn main drive shaft.
- Worm gears that drive wheel and tiller shafts may be worn.

4 Wheels Turn, But Tines Won't:

- Tines/PTO Clutch Lever must be in ENGAGE position. See Section 3.
- Tines/PTO Clutch Lever may need adjustment.
- Key for "dog" clutch on tine attachment main drive shaft may be missing, broken.
- Worm gears that drive the tine shaft may be worn.
- Hardware holding tine holders to tine shaft may be missing or broken. To check, remove holders. See Section 5.
- Key for bronze worm gear on tine attachment main drive shaft may be missing or broken.

5 Tines Turn, But Wheels Won't:

- Check operation of Wheel Speed Lever. Refer back to Problem 2.
- Hi-Pro key inside wheel clutch may be missing, broken. If so, clutch will not turn wheel shaft.
- FAST and SLOW speed wheel gears may be worn. If only one gear is worn, there will only be one wheel speed.
- Worm gear that drives pinion shaft and pinion gears may be worn.
- FAST and SLOW speed pinion gears may be worn. If only one gear is worn, there will only be one wheel speed.
- Drive "dogs" on sides of wheel clutch may be worn or broken. If only one side of clutch is affected, there will only be one wheel speed.

6 Wheels And Tines Turn On Top Of Ground, But Stop Or Hesitate In Soil:

- Drive belt may be loose. See Section 5.
- Mounting bolt for transmission drive pulley may be loose. See Photo 5-1.

7 Tiller Jumps While Tilling:

- Depth Regulator Lever set too deep for soil conditions. Lower lever for shallower setting.
- Engine throttle speed too fast.
- Tiller wheel speed too fast for soil conditions. Change to LOW belt range or SLOW wheel speed.

8 Depth Regulator Lever Difficult To Move:

- Lubricate spring assembly and depth adjustment bar. See Section 5.
- Check for bent depth adjustment bar.

9 Wheel And Shaft Move Out To One Side:

- Snap ring on wheel shaft may be dislodged from its groove. Raise wheels off ground and check for back and forth play in shaft. If there is play, one or both snap rings is loose.

10 Tiller Pulls To One Side:

- Check tire pressure. See Section 5.

11 Tine Holder Bolt Breaks Or Loosens:

- Earlier models have tine holder keys. Check that keys are in keyways of tine shaft. Without key in holder, left-side tine bolt will tighten and break; right-side bolt will loosen. See Section 5.

12 Poor Traction:

- Bar tread tires, tire chains, or wheel weights may be needed. See "Attachments."

13 Gear Oil Leak From Power Unit Or Tine Attachment Transmissions:

- See Section 5.

14 Engine Lacks Power:

- Air cleaner restricted with dirt and/or oil. See Section 5.

- Spark plug wire loose or damaged. Spark plug worn or fouled. See Section 5.
- Engine under excessive work load. Use SLOW wheel speed and LOW belt range.
- Throttle cable may be loose or mis-adjusted. See Section 5.
- Verify that engine isn't running with choke partially engaged. See Section 3.
- Carburetor may need adjustment. See Section 5.
- Engine overheating. Check oil level and clean cooling fins. Oil may be very dirty. Let hot engine cool before restarting.
- Dirt or water in fuel or fuel system.
- Engine crankcase low in oil, or over-filled with oil. Check and adjust level.
- Low engine compression.

15 Engine Difficult To Start:

- Wheels/Tines/PTO Drive Lever not in NEUTRAL position.
- Fuel tank low or empty.
- Dirt or water in fuel or fuel system.
- Fuel line is restricted.
- Choke not set properly. See Section 3.
- Spark plug worn or fouled (weak spark). See Section 5.
- Air cleaner restricted with dirt and/or oil. See Section 5.
- Throttle cable not properly adjusted. See Section 5.
- Engine throttle lever not free to move through its full operating range.
- Throttle wire and its linkage are binding, or are bent and not free to move.
- Low engine compression.

16 Engine Won't Start:

- See "Troubleshooting the Forward Interlock Safety System" in Section 5.
- Wheels/Tines/PTO Drive Lever not in NEUTRAL position.
- Fuel tank low or empty. Or fuel line restricted or clogged.
- Choke improperly set. See Section 3.
- Water or dirt in fuel, and /or fuel system.

- Spark plug fouled or worn. Spark plug wire loose or damaged. See Section 5.
- Carburetor may need adjustment.
- Air filter clogged with oil or dirt. See Section 5.
- Carburetor float faulty (or float valve leaking)— if so, tap side of bowl lightly with handle of screwdriver (or similar object).
- Fuel is stale— won't vaporize properly, gums up carburetor float, channels and valves. Drain old fuel and add new fuel.
- Fuel tank shut-off valve not in "Open" position. See Section 3.
- On Briggs & Stratton engine, On/Off switch not in ON position.

On Electric Start Engines Only:

- Electrical connections loose or shorted against metal frames, brackets or covers. See Section 5.
- Battery discharged. See Section 5.
- Electric starter motor faulty.

17 Engine Shuts Off When Wheels/Tines/PTO Drive Lever Is In Forward:

- See "Troubleshooting the Forward Interlock Safety System" in Section 5.

18 Engine Overheats

- Clean the engine cooling fins, shroud and covers. See Section 5.
- Check for broken flywheel fins (under engine shroud). See Authorized Engine Dealer.
- Check oil level for correct amount.

19 Engine Runs Erratically:

- Water or dirt in gasoline or carburetor.
- Carburetor may need adjustment. See Engine Manufacturer literature.
- Spark plug fouled or dirty. Spark plug wire loose or damaged. See Section 5.
- Loose or cracked carburetor.
- Governor linkage not adjusted properly or binding. See Authorized Engine Service Dealer. Don't attempt to repair by yourself.

- Check pan gasket, engine seals and drain plugs for leaks. See your Authorized Engine Service Dealer.

20 Engine Runs Well, But Labors Under Tiller Load

- Check governor linkage for freedom of movement.
- Check throttle setting and carburetor adjustment. See Engine Manufacturer literature.
- Tilling depth is possibly too deep. To correct, lower the depth regulator lever.
- Possible worn bronze tiller worm gear or loose drive shaft (on well-used tiller).

21 Key Switch Will Not Start The Engine

- Check battery terminals for corrosion. See Section 5.
- Discharged battery. See Section 5.
- Defective solenoid.
- Short in key switch or key switch wire harness.
- Check starter motor mounting bolts for looseness. Have Authorized Engine Service Dealer inspect the starter motor.

Attachments

ATTACHMENTS AND ACCESSORIES FOR YOUR TILLER

Hiller-Furrower Attachment

The most popular attachment because it does so many jobs.

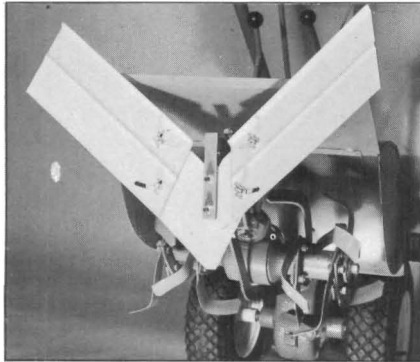

Mounts to the rear of the depth regulator bracket. Furrower blade easily makes plant rows, trenches, ditches to 8" deep. When hiller wings are attached to furrower blade, attachment makes hilled rows and raised bed gardens. Converts from a furrower to a hiller and back again, in seconds, without tools.

Row Marker Attachment

Do you like very straight, even, neat rows in your garden? If so, the Row Marker is a must attach-



ment. Hooks quickly to the Hiller/Furrower attachment—eliminates the need for string, stakes, measuring tape, etc. You'll like the straight rows it helps you make if you lay out furrows, dig compost trenches, or make raised beds. The Row Marker extends from 28"-to-49¼", letting you vary the width between rows to suit the crop you're planting.

Wheel Weights

Help increase traction by putting extra weight directly on the wheels. They reduce bucking and jumping when deep-tilling in heavy soil. They're shipped empty—fill them with material like concrete, sand, gravel, etc. They bolt directly to the tiller wheels.

Wrap-Around Bumper Guard

Order this Bumper Guard by itself or receive it as one of the components if you order the combination Dozer/ Snow Blade attach-



ment. Protects the engine from damage by wrapping around and protecting many of the engine components. 1" diameter, high-strength steel tubing.

Dozer/Snow Blade Attachment

In the winter, moves up to one foot of light snow (or 6"-to-8" of heavy snow); at other times use it to move or spread sand, gravel, loose dirt, grain, sawdust, etc. Attaches easily to the front of the Wrap-Around Bumper Guard. Set the blade to several angles. Weighs 41-lbs.; measures 15" x 32".



Hardened-Face Tilling Tines

Our standard Bolo Tines do a fine job. But if you do custom tilling or lots of tilling for long hours—consider these hardened-face tines that are 1/4" thick and made of a special cast, high chrome carbon alloy. They can last 2-1/2 times longer.

Tire Chains

Chains provide extra traction when snowplowing, or under wet or slick conditions.

Tow Hitch Attachment

Converts your tiller to a tractor-type hauling machine. Connects quickly to the rear of the tiller Power Unit. This is a standard-type tow hitch so it can tow many kinds of equipment.

PTO Chipper/Shredder

Powered by your Horse Model Tiller engine, the PTO Chipper/Shredder is a work horse. Chips branches to 3" in diameter and shreds materials to 1/2" thick.



OTHER WORK-SAVING TROY-BILT ATTACHMENTS:

- Troy-Bilt® PTO Generator
- Sweep Cultivator Attachment
- Troy-Bilt® Kickstand
- Tine Attachment Cradle

TILLER SPECIFICATIONS

Height —

(Approximate minimum heights)

Handlebars in lowest setting: 37¼" *

Handlebars in highest setting: 49½" *

Without Handlebars: 33¼" **

* Tines resting on ground.

** Measured from knob on Wheels/Tines/
PTO Drive Lever to the ground.

Length —

(Approximate minimum lengths)

With Handlebars: 60"

Without Handlebars: 56½"

Width —

Hood width: 22½"

Tilling width: 20"

Weight —

(Approximate weight of assembled tiller including motor oil in engine, but excluding gasoline in fuel tank and weight of shipping container)

7HP Recoil Start Model: 284 lbs. *

7HP Electric Start Model: 310 lbs. *

8HP Recoil Start Model: 296 lbs. *

8HP Electric Start Model: 324 lbs. *

Transmission —

Consists of two separate transmissions, the Power Unit transmission and the Tine Attachment transmission. Both transmissions are encased in cast iron housings and operate in separate baths of gear oil. The housings are securely connected by a locking collar, a dowel pin, and two large swing-bolts. By loosening the swing-bolts, the Power Unit can be disconnected from the Tine Attachment and used as a separate power source for optional powered and non-powered PTO attachments.

Transmission Gear Oil —

Small Top-Offs: use SAE 140, SAE 85W-140, or SAE 80W-90. Must have an API rating of GL-3, GL-4 or GL-5.

Full Replacement: use SAE 140 or SAE 85W-140 with an API rating of GL-4 only.

Power Unit Gear Oil Capacity: approximately 60 ounces. Important— use the oil level check hole as your *final* guide for gear oil level correctness.

Tine Attachment Gear Oil Capacity: approximately 12½ ounces, but use the transmission dipstick as the *final* guide.

Transmission Gear Oil Capacity —

PTO Power Unit: 60 ozs (approx.)

Tine Attachment: 12½ ozs (approx.)

Wheels —

One-piece steel; 8" in diameter.

Tires —

7HP Model and 8HP Model are equipped with 4:80 x 8" bar tread tires.

Recommended air pressure is 10-to-20 pounds/square inch.

Engine Specifications —

Please see the engine manufacturer literature supplied with your tiller for complete specifications and details regarding the engine.

Wheel And Tine Speeds

At 3000 RPM (revolutions per minute) engine speed, the wheel and tine speeds are as follows:

BELT POSITION	WHEEL SPEED LEVER POSITION	WHEEL SPEED	TINE SPEED
Low Range	Slow	.5 MPH	146 RPM
Low Range	Fast	1.2 MPH	146 RPM
High Range	Slow	.7 MPH	200 RPM
High Range	Fast	1.72 MPH	200 RPM

Index

- A**
 - Air Cleaner**
 - Foam Pre-Cleaner, 57
 - Paper Element, 57
 - Service Schedule, 44
 - Air Cooling System, Engine**
 - Check Air Cooling, 25
 - Service Schedule, 44
 - Air Pressure, Tires**, 16, 44, 56, 65
 - Assembly**
 - Carton Contents, 9
 - Electric Start System, 16-19
 - Engine Throttle Lever, 15
 - Forward Interlock Wire Harness, 12
 - Gear Oil Levels, 14-15
 - Handlebars, 11
 - Inspection on Delivery, 9
 - Motor Oil Adding, 15
 - Tire Air Pressure, 16
 - Wheels/Tines/PTO Drive Lever, 12-13
 - Attachments and Accessories**
 - Bar Tread Tires, 65
 - Custom Tilling Tines, 64
 - Dozer/Snow Blade, 64
 - Hiller/Furrower, 39, 64
 - Kickstand, 40
 - PTO Chipper/Shredder, 64
 - Row Marker, 64
 - Sweep Cultivator, 64
 - Tine Cradle, 40
 - Tire Chains, 64
 - Tow Hitch, 64
 - Wheel Weights, 64
 - Wrap-Around Bumper Guard, 64
 - Authorized Engine Service**, 4
- B**
 - Bar Tread Tires**, 65
 - Battery**
 - Activation, 17
 - Care in Service, 58
 - Care in Storage, 58-59
 - Charging, 17-18
 - Installation, 19
 - Removal/Replacement, 59
 - Service Schedule, 44
 - Troubleshooting, 61-63
 - Beds, Raised**, 39
 - Belt**
 - Adjusting Tension, 49-50
 - Changing Speed Ranges, 32-33
 - Inspection, 49
 - Replacement, 51
 - Bolo Tines** (see "Tines")
 - Bolts and Nuts**, 45
 - Break-In Operation**, 25
 - Bumper/Guard**, 64
- C**
 - Cable, Throttle** (see "Throttle Lever")
 - Chains, Tire**, 64
 - Chart, Maintenance**, 44
 - Choke Control**
 - Function, 23
 - Operation, 23, 27-28
 - Chipper/Shredder**, 64
 - Clutch Roller**, 13, 21, 49
 - Cold Weather Operation**, 28
 - Composting**, 35
 - Controls**
 - Engine, 23
 - Tiller/Power Unit, 20-22
 - Cornstalks**, 36
 - Cover Crops**, 34-35
 - Cradle, Tine**, 40
 - Crop Residues**, 35
 - Cultivating**, 35
 - Custom Tilling Tines**, 64
- D**
 - Decals**, 8
 - Depth Regulator Lever**
 - Function, 22
 - Operation, 22, 27
 - Tiller Depths, 22
 - Troubleshooting, 46, 62
 - Disc Reverse**
 - Inspection, 52
 - Replacement, 52
 - Dozer/Snow Blade**, 64
 - Drive Belt** (see "Belt")
- E**
 - Eccentric Lever**, 45, 62
 - Electric Start System**
 - Assembly, 16-19
 - Maintenance, 58-59
 - Operation, 23, 27
 - Starting with Recoil Rope, 28
 - Troubleshooting, 61-63
 - (Also see "Battery")
 - Engine**
 - Air Cleaner, 57
 - Air Cooling System, 25
 - Authorized Service, 4
 - Choke Control, 23
 - Cold Weather Operation, 28
 - Controls, 23
 - Fuel, 25
 - Fuel Valve, 23
 - Ignition System, 23, 57
 - Key Switch Starter, 23
 - Model Code Number, 3
 - Off-Season Storage, 60
 - Oil, 15, 25, 56
 - Operation, 23, 25, 27-28
 - Recoil Starter, 23
 - Spark Plug, 57
 - Specifications, 65
 - Starting and Stopping, 27-28
 - Throttle Cable, 15, 57
 - Throttle Lever, 15, 23, 57
 - Troubleshooting, 61-63
- F**
 - Factory Service**, 4
 - Footprints**, 35
 - Forward Interlock Levers**
 - Function, 26
 - Inspection, 26
 - Operation, 26
 - Test Procedure, 26
 - Forward Operation**, 20, 29-30
 - Free Wheel**, 21
 - Fuel**, 25
 - Fuel Valve**, 23
 - Furrower**, 39, 64
- G**
 - Gardening**
 - Cornstalks, 36
 - Cover Crops, 34-35
 - Crop Residues, 35
 - Cultivating, 35
 - Green Manures, 35
 - Leaves, 35
 - Power Composting, 35
 - Raised Beds, 39
 - Seedbeds, 34
 - Slopes/Terraces, 37-38
 - Wide Rows, 39
 - Gasoline**, 25
 - Gear Oil**
 - Adding, 48
 - Changing, 48-49
 - Checking for Leaks, 46
 - Checking the Level, 47
 - Type and Capacity, 48
 - Generator**, 64
 - Grease**, 46
 - Green Manures**, 34-35
- H**
 - Handlebar Height Adjustment**, 22
 - Height, Tiller**, 65
 - High Range Speed**, 33
 - Hiller/Furrower**, 39, 64
 - Hitch, Tow**, 64
 - Housing Cover, Tiller**, 45, 49
- I**
 - Ignition System**, 57
 - Introduction**, 2
 - Inspection After Delivery**, 9
- J**
 - Key Switch Starter**
 - Connecting Keyswitch, 18
 - Function, 23
 - Operation, 23, 27-28
 - Troubleshooting, 63
 - Kickstand**, 40
- L**
 - Leaks, Oil**, 46
 - Leaves**, 35
 - Length, Tiller**, 65
 - Levers**
 - Choke Control, 23, 27-28

TILLER WARRANTY TRANSFER CARD

If Tiller is sold or transferred, please have the new owner fill in this card and send it to us so we can transfer the FULL NO-TIME-LIMIT WARRANTY to him. Thank you!

PTO Horse Model TROY-BILT® Roto Tiller-Power Composter

Tiller Serial Number _____

Engine: 7 HP 8 HP Standard Start Electric Start

Date of Shipment: Month _____ Day _____ Year _____

New Owner

Former Owner

First Name _____ Middle Initial _____ Last Name _____

First Name _____ Middle Initial _____ Last Name _____

Street & Number (or R.R. & Box Number) _____

Street & Number (or R.R. & Box Number) _____

City _____ State _____

City _____ State _____

County _____ Zip _____

County _____ Zip _____

Area Code _____ Phone Number _____

Area Code _____ Phone Number _____

Save this card until needed

SHP-33(4/87)

BrentChalmers.com

© 1987 Garden Way Inc.



NO POSTAGE
NECESSARY
IF MAILED
IN THE
UNITED STATES

BUSINESS REPLY MAIL

FIRST CLASS

PERMIT NO. 6

TROY, N.Y.

POSTAGE WILL BE PAID BY ADDRESSEE

**Garden Way Incorporated
102nd Street and Ninth Avenue
Troy, New York 12179-0001**



BrentChalmers.com



- Depth Regulator, 22, 27, 46, 62
 Engine Throttle, 15, 23, 57
 Forward Interlock, 26
 Handlebar Height, 22
 Tines/PTO Clutch, 22, 27, 42, 46
 Wheels/Tines/PTO Drive, 20, 27, 29, 61
- Loading/Unloading**, 31
Low Range Speed, 32
Lubrication Points, 46
- M Maintenance**
 Air Cleaner, 57
 Air Cooling System, 25
 Battery, 58-59
 Bolo Tines, 54-55
 Bolts and Nuts, 45
 Chart, 44
 Drive Belt, 49-51
 Engine Oil, 56
 Forward Interlock System, 60
 Ignition System, 57
 Lubrication Points, 46
 Maintenance Schedule, 44
 Reverse Drive, 52-54
 Spark Plug, 57
 Storage, 8, 60
 Throttle Cable, 57
 Tine Shaft, 56
 Tines, 54-55
 Tires, 56
 Transmission Gear Oil, 46-49
- Manures, Green**, 34-35
Model Number, 3
Motor Oil (see "Oil, Engine")
- N Neutral** (see "Wheels/Tines/PTO Drive Lever")
Non-Powered Attachments, Use, 43
Nuts and Bolts, 10, 45
- O Oil, Engine**,
 Adding, 15
 Changing, 56
 Checking Level, 56
 Service Schedule, 44
 Type and Capacity, 15
- Oil, Transmission Gear**
 Adding, 48-49
 Changing, 48-49
 Checking for Leaks, 46
 Checking Level, 14-15, 47
 Type and Capacity, 48, 65
- Operating Instructions**,
 Power Unit, 42-43
 Tiller, 29-39
- Options/Attachments** (see "Attachments and Accessories")
- P Parts Ordering**, 4
Power Composting, 35
Preparation, Safety, 6
- PTO Power Unit**,
 Description, 2
 Operation, 40-43
- Pulley, Transmission**, 32-33
- Q**
- R Raised Beds**, 39
Recoil Starter, 23, 27-28
Reverse Drive Maintenance,
 Adjustments, 53-54
 Replacement, 52
 Reverse Disc, 52-54
- Reverse Operation** (see "Wheels/Tines/PTO Drive Lever")
- Row Marker**, 64
- S Safety Decals**, 8
Safety Instructions, 5-8
Seedbeds, 34
Serial Number, Tiller, 3
- Service**,
 Engine, 4
 Factory, 4
- Shredder/Chipper**, 64
Slope Gardening, 37
Solenoid, 63
Spark Plug, 57, 63
Specifications, 65
Speeds, 32-33, 65
- Stationary Attachments Operation**, 42-43
- Starting/Stopping**
 Engine, 23, 27-28
 PTO Power Unit, 29-30, 42-43
 Tiller, 28-29
- Storage**, 60
Sweep Cultivator, 64
Swing Bolts, 41-42, 45
- T Table of Contents**, 3
Terraces, 38
Throttle Cable, 15, 57
Throttle Lever, 15, 57
- Tiller**,
 Controls, 20-22
 Maintenance, 44-56, 58-63
 Operation, 29-30
 Safety, 5-8
 Specifications, 65
 Troubleshooting, 61-63
 Tilling, 34-39
- Tilling Depths**, 34
Tine Attachment, 40-42, 55
Tine Cradle, 40
Tine Holders, 55
Tine Shaft, 56
Tine Speeds, 33
Tines,
 Cleaning, 37
 Custom Tilling, 64
 Inspection, 54
 Single Tine Replacement, 55
- Tines/PTO Clutch Lever**
 Function, 22
 Operation, 27, 29-31
 Maintenance, 46
- Tires**
 Air Pressure, 56
 Bar Tread, 65
 Chains, 64
 Wheel Removal, 56
- Tow Hitch**, 64
Training, Safety, 5
Transmission Gear Oil (see "Oil, Transmission Gear")
Transporting Tiller, 31
Travel Setting, 22, 29
Troubleshooting, 61-63
Turning Around, 30
- U Unloading/Loading**, 31
Untangling Tines, 37
Uphill Tilling, 37
- V Vertical Tilling**, 37
Viscosity,
 Engine Oil, 15
 Gear Oil, 14, 48, 65
- W Warranty, Tiller and Engine**, Back Cover
Warranty Registration Card, 2
Warranty Transfer Card, 2
Weight, Tiller, 65
Wheel Speed Lever,
 Function, 21
 Operation, 27, 29
 Troubleshooting, 61-62
- Wheel/Tine Speeds**, 21, 32-33
Wheel Weights, 64
Wheels (see "Tires")
Wheels/Tines/PTO Drive Lever,
 Function, 20-21
 Forward Operation, 29
 Neutral, 30
 Reverse Operation, 30
 Troubleshooting, 61
- Wide Rows**, 39
Width, Tiller, 65
Wrench, PTO, 40-42
- X**
Y
Z

FULL NO-TIME-LIMIT WARRANTY

Your TROY-BILT® Roto Tiller - Power Composter is warranted by Garden Way Incorporated to be free from defects in materials and workmanship. This warranty will remain in effect for the life of the machine and will be transferred automatically to any and all subsequent owners.

We or your authorized dealer will repair or replace, at no cost to you, any part we find to be defective with the exception of the engine, which is warranted separately by the engine manufacturer. Garden Way Incorporated does, however, extend the length of the engine manufacturer's warranty, providing you with coverage for a total of three (3) years. (Call or write to us for a FREE copy of the engine warranty.)

This FULL NO-TIME-LIMIT WARRANTY also applies to all non-powered attachments. Powered attachments are warranted separately by their manufacturers.

If we determine them defective, even parts that wear in normal use, such as belts, bearings, blades, tires, and tines are covered under this warranty and will be replaced or repaired without charge. Failures or malfunctions caused by normal wear and tear, use of unauthorized accessories or attachments, misuse, or accident are not covered.

FULL ONE-YEAR COMMERCIAL USE WARRANTY: If used for commercial, institutional, industrial, rental, or demonstrator purposes, the warranty on this product is limited in duration to one (1) year from date of purchase. The engine warranty for commercial use is a LIMITED WARRANTY also in effect for one (1) year from date of purchase. Proof of purchase is required to obtain commercial warranty service.

How to Get Service: To obtain warranty service, contact Garden Way Incorporated at 102nd Street & 9th Avenue, Troy, NY 12180, or call us TOLL FREE at 1-800-520-5520, or consult your Yellow Pages for the name of the authorized TROY-BILT product dealer nearest you.

Your Rights Under State Law: This warranty gives you specific legal rights, and you may also have other rights which vary from state to state.

TROY-BILT FACTORY DIRECT 30-DAY TRIAL

TROY-BILT® Mfg. wants you to be completely satisfied with your product. If you are not totally satisfied with the condition or performance of your TROY-BILT product, you may exchange your product or receive a refund of the purchase price of your merchandise. To receive your refund, you must contact us within 30 days after you receive your order, and follow the return instructions.



For customer assistance, contact your nearest authorized dealer or:

In the United States: GARDEN WAY INCORPORATED • 102nd St. and 9th Ave. • Troy, New York 12180

For Technical Service: (800) 520-5520 • For Parts: (800) 648-6776

In Canada: GARDEN WAY INCORPORATED • 320 Van Sickle Rd., Unit 12 • Saint Catherines, Ontario L2R 6P7

For Technical Service or Parts: (800) 225-3585

BrentChalmers.com