

TROY-BILT

JUNIOR TOMAHAWK®

3 HP Chipper/Shredder



Preparation • Safety • Controls • Operation • Maintenance

WE'RE HERE TO SERVE YOU . . .

Dear Owner:

We've prepared this Owner/Operator Manual to guide you in the proper use of your new JUNIOR TOMAHAWK® Chipper/Shredder and we've included a special section on Safety Instruction which we urge you to read completely. Your safety, and the safety of other operators and those around you, make the Safety Instruction — and the entire Manual — "must reading" **before** you put this equipment to work. There's a section on Maintenance and Service too, so you'll be able to keep your Chipper/Shredder running at peak performance at all times.

Of course, if you have any questions or problems at all with operation or service, please contact our Technical Service Department right away (the phone number is on the next page). Don't hesitate to ask for assistance. We want to do all we possibly can to make the time you spend using this equipment as productive and as enjoyable as can be.



Thank you,

Dean Leith, Jr.

Dean Leith, Jr.
Sales Manager

IMPORTANT — WRITE THE SERIAL NUMBER OF YOUR JUNIOR TOMAHAWK® CHIPPER/SHREDDER IN THE SPACE PROVIDED BELOW . . .

To provide fast and efficient service should you contact us, we'll need to know the SERIAL NUMBER of your Chipper/Shredder. The photo at right shows you where to look to find this number. For ready reference, please record your Serial Number and delivery date below.

Serial Number _____

Delivery Date _____

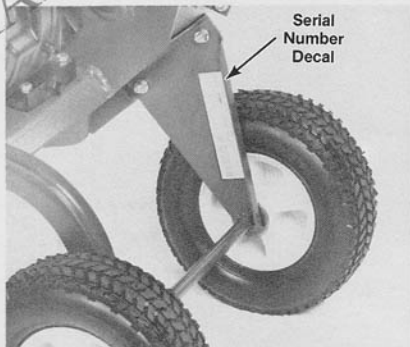

Your Serial Number is located here.

▲ WARNING TO CALIFORNIA OWNER/OPERATORS

Under California Law, you are not permitted to operate an internal combustion engine using hydrocarbon fuels on any forest covered, brush covered or grass covered land; or on land covered with grain, hay, or other flammable agricultural crop without an engine spark arrestor muffler in continuous effective working order. The engine on your Chipper/Shredder, like most garden equipment, is an internal combustion engine that burns gasoline (a hydrocarbon fuel); therefore, it must be equipped with a spark arrestor muffler in proper working order. The spark arrestor must be attached to the engine exhaust system in such a manner that flames or heat from the system will not ignite flammable material. Failure of the operator to comply with this regulation is a misdemeanor under California Law.

Chipper/Shredder Service:

You'll find helpful service and maintenance procedures in this Owner/Operator Manual, so be sure to look here first. . . all the help you need may be right in the Manual. Just look at the Table of Contents below for subject areas and page number references.

If you do not find the answers you need in this Manual, please contact us either by letter or phone, whichever you prefer. Remember, we'll need the Serial Number of your equipment to give you the most efficient service possible.

SEND SERVICE LETTERS TO:

Troy-Bilt Mfg. Company c/o Technical Service Dept. 102nd St. & 9th Ave., Troy, NY 12180	Garden Way Canada, Inc. 1515 Matheson Blvd., Unit B11 Mississauga, Ontario L4W2P5
--	--

OR TELEPHONE:

In the U.S.:
CALL TOLL-FREE 1-800-833-6990

In Canada:
Local only (416 Area Code), Call 624-8423
From Ontario & Quebec, Call Toll-Free 1-800-387-3351
From Western Canada and the Maritime Provinces,
Call Toll-Free 1-800-387-3316

When calling, ask for our *Technical Service Dept.* Our Technical Service Representatives are available from 8:00 A.M. to 7:00 P.M. (Eastern time) Monday through Friday, and from 9:00 A.M. to 4:00 P.M. on Saturdays, except on holidays.

Chipper/Shredder Parts:

For parts only, please write or telephone, using the address or telephone number given at left. Ask for the *Parts Dept.* Before writing or calling, refer to the Parts Listing you received to find out the Part Description and the Part Number of each item you'll be ordering. Be sure to include this information in your letter, or have it on hand if you're calling us.

Engine Service & Repairs:

Please contact your nearest authorized Tecumseh engine dealer if engine service or repair is needed. This listing is in the phone book "Yellow Pages" under "Engines, Gasoline" or "Gasoline Engines." The Service Outlet will need to know the Model and Serial Number of your engine. Section 5 in this Manual shows you how to locate these numbers.

Your local Tecumseh Dealer can handle all repairs, parts orders and warranty service concerning the engine alone. If you wish to contact us before seeing the local Engine Dealer, or if you have difficulty getting engine service or parts locally, be sure to let us know. See the enclosed Engine Manufacturer's literature for full terms of the Limited Warranty on the engine and other details about the engine.

TABLE OF CONTENTS

	Page No.
Section 1 — SAFETY INSTRUCTIONS	2 - 4
Section 2 — INITIAL PREPARATION	5 - 6
Section 3 — FEATURES & CONTROLS	
Chipper Shredder Features/Controls	7 - 9
Engine Features/Controls	10
Section 4 — OPERATING INSTRUCTIONS	
Materials for Chipping & Shredding	11
Pre-Starting Instructions	12
Starting & Stopping Instructions	13
Using the Chipper and Shredder	13 - 15
Section 5 — MAINTENANCE & SERVICE	16 - 21

SECTION 1: SAFETY INSTRUCTIONS — IMPORTANT!

⚠ DANGER

CONTACT WITH ROTATING CUTTING BLADES INSIDE DISCHARGE OPENING WILL CAUSE SERIOUS PERSONAL INJURY! CUTTING BLADES ARE ROTATING WHILE MACHINE IS RUNNING, AND CONTINUE TO ROTATE UNTIL ENGINE COMES TO A COMPLETE STOP.

KEEP HANDS, FEET, FACE, AND CLOTHING OUT OF SHREDDER HOPPER INLET AND CHIPPER CHUTE INLET AND AWAY FROM THE DISCHARGE AREA AND MOVING PARTS AT ALL TIMES TO AVOID SERIOUS INJURY. BEFORE DOING MAINTENANCE OR SERVICE, PUSH SHUT-OFF TAB (On Top Of Engine) AGAINST SPARK PLUG AND HOLD THERE UNTIL ALL MOVING PARTS HAVE COME TO A COMPLETE STOP. DISCONNECT THE SPARK PLUG WIRE.

Please read and follow all of the safety instructions in this Safety Section. **Failure to comply can result in serious personal injury or property damage.** If you have questions, or are not completely sure about any of the information found here or elsewhere in this Manual, please call us for assistance before you operate your equipment.

SAFETY BEFORE STARTING THE ENGINE

1. Become familiar with this Owner/Operator Manual before attempting to operate your equipment.
2. Know where the engine Shut-Off Tab is located and how to use it. This tab-shaped control is next to the spark plug on top of the engine. To stop machine, hold Tab against the spark plug until the engine has stopped completely.
3. The operation of any powered machine can result in foreign objects being thrown by high speed rotating parts. Always wear appropriate work gloves, sturdy footwear, and hearing protection while using your equipment. Always wear approved safety glasses or other eye protection when using the equipment. Do not wear loose-fitting clothing, jewelry, scarves, ties, etc. that can get caught in moving parts.
4. The engine must be OFF and allowed to cool for several minutes before filling the fuel tank with gasoline. Use only an approved gas storage container. Gasoline and its vapors are highly flammable and explosive. Keep matches, flame, and smokers' materials far away from fueling area. Fill fuel tank outdoors. Wipe up fuel spills right away.
5. Before starting the engine, make a visual check to see that all screws, nuts, bolts and other fasteners are properly secured. The Discharge Screen (or the Wet Material Baffle Attachment) must be in place and properly secured. Disconnect the spark plug



wire before performing this check. **This check is recommended before each usage.**

6. Before starting the engine, be sure that the chipper chute, shredder hopper and internal cutting chamber are empty and the service door is securely closed with a rod and hair pin. The engine must be off, all parts completely stopped, and the spark plug wire disconnected before you do this.

SAFETY DURING OPERATION

7. Keep hands, feet, face, and clothing out of shredder hopper inlet and chipper chute inlet and away from discharge area and moving parts to avoid serious injury.
8. Keep hands and feet out of discharge opening when machine is running. Rotating cutting blades inside opening will cause serious personal injury.
9. If unit jams or becomes clogged, push Shut-Off Tab (on top of engine) against spark plug and hold there until all moving parts have come to a complete stop. Disconnect the spark plug wire. Only then inspect the shredder hopper inlet, chipper chute inlet, internal cutting chamber, discharge screen (or wet material baffle attachment) and discharge area. Use only a wooden stick to clear away jammed material and discharged material.
10. Do not run the engine in an enclosed area. The exhaust fumes from the engine contain extremely dangerous carbon monoxide gas. It is colorless, odorless, tasteless and deadly poisonous.
11. Do not put material thicker than $\frac{1}{2}$ " in shredder hopper. Failure to comply may result in engine damage.
12. Do not operate the Chipper/Shredder on a paved, hard, or gravel surface. Discharged material may bounce from a hard surface and cause personal injury. Select a level, earthen surface.
13. Always stand clear of the Discharge Area when operating your equipment.



14. Do not put hands, feet, face, or any other parts of your body or clothing near the Chipper Chute, Shredder Hopper, or Discharge Area. Cutting blades will begin to rotate and build up speed once the engine is running. Personal injury will occur unless rotating cutting blades have completely stopped.



15. Do not allow children or untrained adults to operate the equipment.
16. When feeding appropriate material into the Chipper or Shredder, be extremely careful that pieces of metal, rocks, bottles, nails, cans and any other foreign objects are not included. Use organic materials only!
17. Shut off the engine immediately if the Chipper/Shredder strikes any foreign object or develops any unusual noises or vibrations. Push Engine Shut-Off Tab (on top of engine) against the spark plug and hold the Tab there until the engine is off and all moving parts have come to a complete stop. Then, disconnect the spark plug wire from the spark plug and take the following steps: a. Inspect for damage; b. If a foreign object is present, remove it; c. Check for loose parts or hardware, and tighten if loose; d. Replace or repair damaged parts before starting the engine.
18. Do not allow engine surfaces, especially around the cooling fins and muffler, to become clogged with leaves, grass, oil, grease, or any other combustible material. Keep these areas clean to avoid a potential fire hazard.
19. Do not allow chipped or shredded material to build up in, or clog, the Discharge Area. Clogging prevents proper discharge of materials and can result in kickback of material up through the Shredder Hopper or Chipper Chute. In order to remove material from the discharge area, use a long-handled shovel or long stick. **NEVER USE YOUR HANDS OR FEET!** Rotating blades cut $\frac{1}{2}$ " from Discharge Screen. Keep away! **Never put your hands or feet in the discharge opening.**
20. Keep all safety shields, guards, screens and deflectors securely in place, properly secured, and in good condition. **Do not operate the unit unless the Shredder Hopper is securely bolted in place and the service door is closed with a rod and hair pin.** Keep your face and body back away from the shredder and chipper feed inlet openings.
21. Do not overreach when feeding material into the Shredder Hopper or Chipper Chute. Always keep arms parallel to the ground while feeding material into Shredder Hopper. Keep proper footing and good balance at all times. Obey the safety and instruction decals on your equipment at all times.

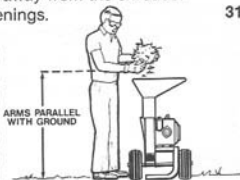

22. Do not transport or move your equipment while the engine is running.
23. Do not tamper with the governor setting on the engine. The governor controls the maximum safe, operating speed and protects the engine and other moving parts from damage that can be caused by overspeeding.
24. Rotating cutting blades do not stop until the engine is off.
25. Do not operate your equipment when bystanders or pets are nearby. Keep bystanders at least 25 feet away from this equipment.
26. Processed material exits at high speed from the Discharge Opening. Keep away from the Discharge Opening and the Discharge Area while operating unit. When shredding, stand on the side of your unit opposite the engine. This way, you will not be close to the hot exhaust muffler.
27. When shredding wet, heavy materials, always have the Wet Material Baffle Attachment securely in place (the Discharge Screen must be removed first, then the Wet Material Baffle Attachment is installed).



SAFETY INSTRUCTIONS FOR MAINTENANCE AND PROPER STORAGE

28. Before service, maintenance, cleaning, inspection, changing the shredder Discharge Screen or the Wet Material Baffle Attachment, or work of any other kind is to be done, be sure to push engine Shut-Off Tab (on top of engine) against the spark plug and hold the Tab there until the engine is off and all moving parts have come to a complete stop. Then, disconnect the spark plug wire from the spark plug. Allow a hot muffler to cool before working near it.
29. Store this equipment where children will not have access to it. Always disconnect the spark plug wire.
30. Be sure the Chipper/Shredder is stored in an area where any gasoline vapors (fumes) from the engine can not reach an open flame, sparks, or flame-producing equipment such as a hot water heater pilot light, a woodstove, or a furnace.
31. For seasonal storage, drain all gasoline from the fuel tank and dispose of it in a safe manner. Then run the engine until the small amount of gasoline left in the carburetor and fuel line has been used up. Disconnect the spark plug wire for storage. Let the engine cool before putting unit in storage.

MAKE SURE THE SAFETY DECALS ON YOUR EQUIPMENT ARE KEPT CLEAN AND IN GOOD CONDITION SO YOU CAN FOLLOW THE INSTRUCTIONS ON THEM!

Please contact us immediately for replacement decals should they become worn or unreadable.



- #1. This Decal (4641 8/88) appears once on the front of your equipment next to the discharge area.

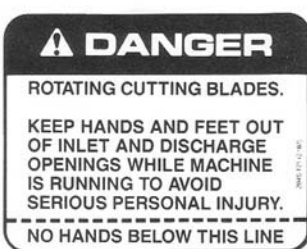

- #2. This Decal (W2045121 5/88) appears once on the top of your equipment inside the shredder hopper.



- #5. This Decal (4647 8/88) appears once on the side of your chipper/shredder right next to the discharge area.



- #4. This Decal (4648 8/88) is located in the neck of your equipment inside the mainframe. It's only visible when the shredder hopper is disconnected and removed for servicing or repair.



- #3. This Decal (4845 8/88) appears once on the side of your equipment next to the chipper chute.



- #6. This Decal (2591) appears once right next to the muffler area.

DANGER

THE ROTATING SHREDDER CUTTING BLADES INSIDE THE DISCHARGE OPENING CUT $\frac{1}{4}$ " FROM THE DISCHARGE SCREEN. CONTACT WITH ROTATING CUTTING BLADES WILL RESULT IN SERIOUS PERSONAL INJURY. KEEP HANDS AND FEET OUT OF DISCHARGE OPENING AND AWAY FROM DISCHARGE AREA WHEN MACHINE IS RUNNING.

IN ORDER TO REMOVE CHIPPED OR SHREDDED MATERIAL FROM THE DISCHARGE AREA, USE A LONG-HANDLED

SHOVEL OR LONG STICK — NEVER USE YOUR HANDS OR FEET! IF MATERIAL SHOULD EVER CLOG THE CHAMBER, DISCHARGE TUNNEL OR DISCHARGE OPENING, OR THE MACHINE SHOULD REQUIRE MAINTENANCE OR SERVICE, ALWAYS STOP UNIT BY PUSHING ENGINE SHUT-OFF TAB (On Top Of Engine) AGAINST SPARK PLUG AND HOLD THERE UNTIL ALL MOVING PARTS HAVE COME TO A COMPLETE STOP. DISCONNECT THE SPARK PLUG WIRE. USE A LONG STICK TO CLEAR THE CLOGGED MATERIAL.

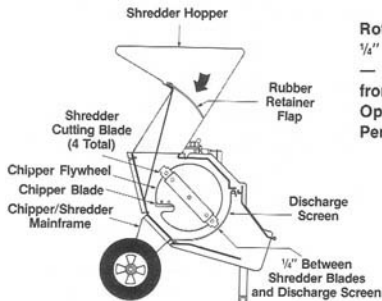

Rotating Shredder Cutting Blades cut $\frac{1}{4}$ " Away From The Discharge Screen — KEEP HANDS AND FEET AWAY from Discharge Area and Discharge Opening At All Times To Avoid Serious Personal Injury!

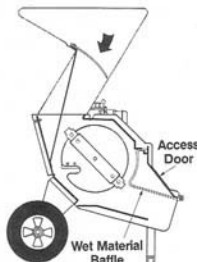

SECTION 2: INITIAL PREPARATION

Now that your TROY-BILT® JUNIOR TOMAHAWK® Chipper/Shredder has arrived, you'll find it's easy to get your equipment ready for use. Be sure to follow all directions in this Section!

IMPORTANT — Motor oil must be added to the engine before starting! This Section provides full instructions. Do not operate your equipment until you have read this Owner/Operator Manual completely.

STEP 1: Inspection After Delivery

Inspect your chipper/shredder right after it has been delivered. Make sure neither the carton nor the contents have been damaged. If you find or suspect damage, contact the trucking company (carrier) right away. Inform them of the specific damage and that you wish to file a claim. *Be sure to put this in writing to the carrier within 15 days after your unit arrived to protect your rights.* The carrier will let you know how to proceed. Of course, if you need assistance, let us know.

STEP 2: Checklist of Components Shipped To You

Your chipper/shredder was shipped to you completely assembled, but we've also included an important attachment for shredding wet material, plus a few other items for your convenience and safety. Please be sure you received them, as listed and shown below. Contact us if anything is missing.

Photo 2-1

Ref. No.	Item Description	Qty.
1	Safety Goggles (universal fit)	1
2	Hex Key Wrench — 1/8"	1 (for service procedures)
3	Oil Funnel	1
4	Wet Material Baffle Attachment	1
5	Hair Pin Clip (extra)	1
6	Leaf Tamper	1
7	Maintenance Roll Pin Kit (includes four spare roll pins and one tube of Loctite 242 sealant — to be used when worn shredder blades need replacement or rotation	1

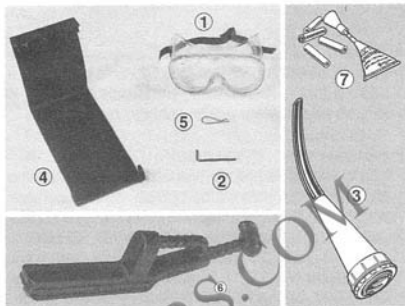

(Photo 2-1) Make sure you received everything shown.

STEP 3: Check Hardware For Tightness

Use an adjustable wrench to verify the tightness of all hardware (bolts and nuts) on your equipment. If you find anything loose or missing, do not use the equipment until the hardware is tightened or the missing item is replaced with a genuine TROY-BILT® replacement part. Work around all four sides of the chipper/shredder with your wrench. See Photo 2-2 below: the bolts and nuts securing the shredder hopper to the mainframe are indicated — they must be very secure.



(Photo 2-2) Double-check hardware tightness all around the equipment — especially the shredder hopper.

STEP 4: Add Motor Oil To Engine

Your engine was shipped “dry” to avoid any possible leakage problems during transit. To add the required amount and type of motor oil to the engine crankcase, please follow these instructions.

Note: the engine must be level for an accurate oil level reading. Please move your equipment off the shipping platform and to level ground. Refer to Section 4 in this Manual for transporting instructions if you're unsure about how to move the chipper/shredder.

Procedure:

As recommended by the engine manufacturer, the motor oil specifications for the 3 Horsepower Tecumseh engine are — Use Clean High Quality Detergent Motor Oil with Engine Service Classification “SF, SE, SD or SC.” In Summer (+32° F), use SAE30 weight motor oil; in Winter (below 32° F), use SAE5W20 weight motor oil or SAE5W30. Note: below 0° F ONLY SAE10W oil diluted with 10% kerosene is acceptable. **FILL CRANKCASE WITH 21 OUNCES OF MOTOR OIL.**

1. Unscrew and remove the Oil Fill Plug near the bottom of the engine on the left-hand side (side with the choke lever/carburetor). Turn it counterclockwise to take it off — refer to Photo 2-3.
2. Slowly pour in approximately 21 ounces of motor oil through the funnel provided to you into the Oil Fill Hole. Add oil until the level is right up to the top of the Oil Fill Tube (see Sketch 2-4). *NOTE: Insufficient oil can cause expensive engine damage!*
3. Replace the Oil Fill Plug securely. If any oil has spilled on the engine, wipe it off completely with a work cloth.



(Photo 2-3) Turn Oil Fill Plug counterclockwise to remove it from the Oil Fill Tube. If tight, use a screwdriver blade as a lever between the two posts.

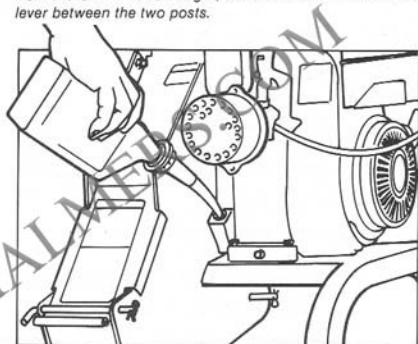

(Sketch 2-4) Insert funnel in fill hole and slowly add about 21 ounces of motor oil. Top off the oil so it's at the brim of the Oil Fill Tube. Replace the plug securely.

SECTION 3: FEATURES & CONTROLS

Before putting your new JUNIOR TOMAHAWK® Chipper/Shredder to work on the projects you've been planning, please read this Section completely to understand exactly how the equipment works and the location and function of all the features and controls. Basically, there are chipper/shredder features and there are engine features.

Chipper/Shredder Features & Controls

Please refer to Photo 3-1 to locate the following chipper/shredder features and controls:

1. Shredder Hopper (inlet)
2. Chipper Chute (inlet)
3. Chipper/Shredder Chamber
4. Discharge Area

(Includes Discharge Screen and Wet Material Baffle Attachment)

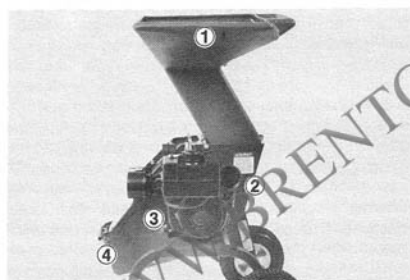

(Photo 3-1) Your equipment has the features/controls shown above.

1. Shredder Hopper (Inlet)

The Shredder Hopper (see Photo 3-2 for a closeup) is located at the top of the unit and is the opening into which all materials to be shredded should be fed. A rubber retainer flap is secured to the hopper. Loose, bulky material must be pushed past the retainer flap with your Leaf Tamper in order to enter the main chipper/shredder chamber where revolving steel cutting blades do the shredding (see "Danger" above). **The retainer flap is an important feature — it prevents kickback of materials! Do Not Use Your Equipment Unless The Rubber Retainer Flap is Securely Fastened.** Most organic materials can be shredded. Section 4 provides a list of materials. **IMPORTANT — Do Not Put Materials Thicker Than 1/2" In Shredder Hopper. Failure To Comply May Result In Engine Damage.**

⚠ DANGER

CONTACT WITH INTERNAL ROTATING CUTTING BLADES WILL CAUSE SERIOUS PERSONAL INJURY. DO NOT PUT HANDS, FACE, FEET, OR CLOTHING INTO THE SHREDDER HOPPER, CHIPPER CHUTE, DISCHARGE OPENING OR NEAR THE DISCHARGE AREA AT ANY TIME. BEFORE DOING MAINTENANCE OR SERVICE, PUSH SHUT-OFF TAB (On Top of Engine) AGAINST SPARK PLUG AND HOLD THERE UNTIL ALL MOVING PARTS HAVE COME TO A COMPLETE STOP. DISCONNECT THE SPARK PLUG WIRE, AFTER ALL MOVING PARTS HAVE STOPPED COMPLETELY, USE ONLY A WOODEN STICK TO CLEAR JAMMED MATERIAL, BLOCKAGES, OR DISCHARGED MATERIAL.



(Photo 3-2) The top-loading Shredder Hopper can be used to shred organic materials up to 1/2" in thickness.

⚠ DANGER

SHREDDED PARTICLES CAN KICKBACK UP THROUGH THE SHREDDER HOPPER INLET UNLESS THE RUBBER RETAINER FLAP IS IN PLACE AND SECURELY FASTENED. PERSONAL INJURY CAN RESULT FROM FLYING PARTICLES.

BEFORE USING YOUR EQUIPMENT, BE SURE THE RETAINER FLAP IS SECURELY ATTACHED AND THAT YOU ARE WEARING PROTECTIVE SAFETY GOGGLES OR GLASSES.

2. Chipper Chute (Inlet)

The Chipper Chute on the side of your equipment lets you process into "chips" larger materials that the Shredder can't handle. The Chipper Chute is shown in a close-up in Photo 3-3. Branches fed into the chute are turned into "chips" by a revolving blade mounted on a flywheel. We recommend that branches and vines from $\frac{1}{2}$ "-to-2" in diameter be fed into the Chipper Chute. Cut your materials into manageable lengths before processing them.

▲ DANGER

CONTACT WITH INTERNAL ROTATING CUTTING BLADES WILL CAUSE SERIOUS PERSONAL INJURY. DO NOT PUT HANDS, FACE, FEET, OR CLOTHING INTO THE SHREDDER HOPPER, CHIPPER CHUTE, DISCHARGE OPENING, OR NEAR THE DISCHARGE AREA AT ANY TIME. BEFORE DOING MAINTENANCE OR SERVICE, PUSH SHUT-OFF TAB (On Top Of Engine) AGAINST SPARK PLUG AND HOLD THERE UNTIL ALL MOVING PARTS HAVE COME TO A COMPLETE STOP. DISCONNECT THE SPARK PLUG WIRE. AFTER ALL MOVING PARTS HAVE STOPPED COMPLETELY, USE ONLY A WOODEN STICK TO CLEAR JAMMED MATERIAL.

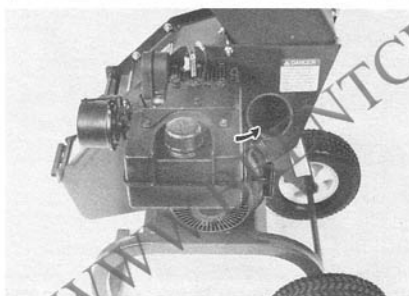

(Photo 3-3) The Chipper Chute is for processing larger, heavier branches ($\frac{1}{2}$ "-to-2" in diameter).

3. Chipper/Shredder Chamber

Inside the steel mainframe chamber of your equipment is a flywheel/cylinder-assembly that is bolted directly to the engine PTO shaft. The round flywheel has a chipper blade attached to it. The cylinder assembly also holds the shredder flail cutting blades that do all the shredding. When your engine is running, the chipper blade and the shredder cutting blades revolve at the same time — making either chipping or shredding available to you. See Photo 3-4 for a view inside the mainframe chamber showing the chipper blade and shredder cutting blades.

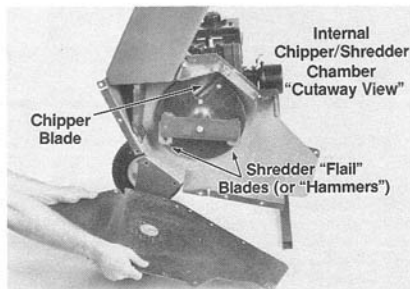

(Photo 3-4) Shown above is the combination chipper flywheel/shredder cylinder assembly. The flywheel holds the chipper blade — feed material into the chipper chute and the chipper blade will process it into chippings. Or feed other material into the shredder hopper and the rotating cutting blades will process it.

4. Discharge Area

The Discharge Area is located near the bottom of your equipment. This is where all chipped and shredded materials exit once they've been processed. See Photo 3-5 for a close-up view of the Discharge Area.

The holes in the Discharge Screen not only provide an exit for processed materials, but hole size determines how finely materials are shredded. Shreddings can't be discharged until they've been reduced to less than the hole size in the screen. The Discharge Screen supplied with your equipment is a general-purpose screen designed to handle many kinds of materials efficiently — it has $\frac{3}{4}$ " diameter holes which let all but wet and green materials exit quickly. Also supplied with your machine is a Wet Material Baffle Attachment that thoroughly processes wet, heavy material with minimal clogging. It must be used in place of the standard screen when processing wet leaves, half-rotted compost, gone-by vegetables, and similar wet materials.

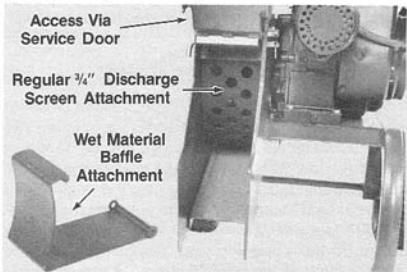

(Photo 3-5) Close-up of the general-purpose Discharge Screen. Chipped and shredded materials exit through the holes in the screen. A special Wet Material Baffle Attachment for processing wet, green materials is also provided. (Inset Photo 3-5.) The Wet Material Baffle Attachment is used in place of the Discharge Screen when you want to shred wet, heavy materials like wet leaves, and gone-by vegetables.

As Photo 3-6 shows, the Discharge Screen can be taken out to allow any blockages to be removed with a stick. First, push the Engine ShutOff Tab (on top of engine) against the spark plug and hold there until all moving parts have come to a complete stop, and disconnect the spark plug wire. To take out the screen, remove the hair pin clips from the screen rods; slide out the screen rods; lift the Service Door, and reach in and remove the screen carefully. Note: to remove the Wet Material Baffle Attachment, only one rod must be removed. After cleaning the holes in the screen or the chipper/shredder chamber with a stick, be sure you replace the Discharge Screen securely (or the Baffle Attachment) with the proper fasteners. **NEVER OPERATE YOUR EQUIPMENT UNLESS THE DISCHARGE SCREEN (OR WET MATERIAL BAFFLE ATTACHMENT) IS SECURELY AND PROPERLY ATTACHED OR PERSONAL INJURY COULD OCCUR. THE SERVICE DOOR MUST ALSO BE CLOSED AND PROPERLY SECURED.**

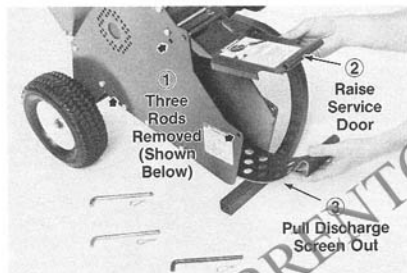

(Photo 3-6) To remove the Discharge Screen for cleaning, remove the two hair pin clips and rods securing the screen, and the single hair pin clip and rod securing the bottom of the Service Door. Lift up the Service Door and pull the screen out.

⚠ DANGER

CONTACT WITH INTERNAL ROTATING CUTTING BLADES WILL CAUSE SERIOUS PERSONAL INJURY. KEEP HANDS, FEET, FACE, AND CLOTHING OUT OF SHREDDER HOPPER INLET, CHIPPER CHUTE INLET, AND AWAY FROM DISCHARGE AREA AND MOVING PARTS AT ALL TIMES. ROTATING CUTTING BLADES ARE TURNING WHEN THE ENGINE IS RUNNING. TO CLEAR THE DISCHARGE SCREEN, OR ANY INTERNAL JAMS OR BLOCKAGES, PUSH SHUT-OFF TAB (On Top of Engine) AGAINST SPARK PLUG AND HOLD THERE UNTIL ALL MOVING PARTS HAVE COME TO A COMPLETE STOP. DISCONNECT THE SPARK PLUG WIRE. AFTER ALL PARTS HAVE STOPPED, USE A STICK OR SHOVEL TO CLEAR MATERIAL OR BLOCKAGES.

IMPORTANT — The Hair Pin Clips are specially designed for your equipment and should be the only style pin ever used on your machine. Failure to replace the Hair Pin Clips properly Could Result In A Condition That Creates The Risk Of Serious Personal Injury.

To Install the Wet Material Baffle Attachment:

First unlock the Service Door (remove the hair pin clip and rod securing it); remove the two hair pin clips and rods that attach the discharge screen; slide out the discharge screen through the opened Service Door; next, position the Wet Material Baffle Attachment as shown in Photo 3-7 — the “rod end” goes in first and hooks inside a retainer at the end of the Service Door; then swing the other end of the Baffle Attachment up around the tubular handle at the end of the Service Door; install one rod and hair pin to secure the Baffle to the door. Close the Service Door and secure it with a rod and hair pin clip. See Photo 3-8.

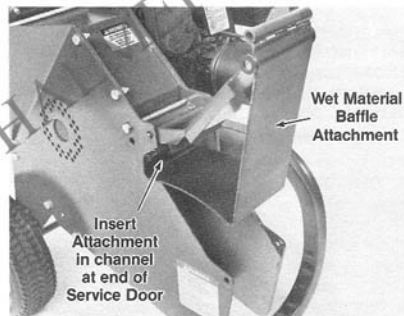

(Photo 3-7) After removing the Discharge Screen, install the Wet Material Baffle Attachment as shown — the “rod end” of the Baffle Attachment goes in first, and fits into the channel at the end of the Service Door.

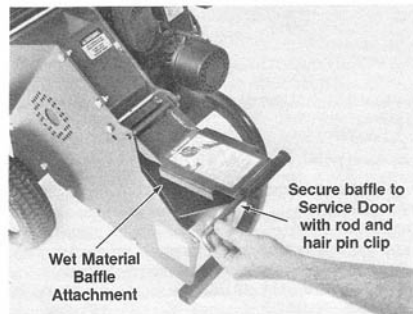

(Photo 3-8) Attach other end of Baffle Attachment to the Service Door using a rod and hair pin clip. Close the Service Door and secure it with a rod and hair pin clip.

Engine Features & Controls

1. Carburetor Choke Control
2. Engine Shut-Off Tab
3. Manual Recoil Start Rope
4. Fuel Tank

1. Carburetor Choke Control

The 3 HP Tecumseh engine has a Choke Control Lever located on the carburetor. See Photo 3-9. This lever lets you regulate the air-fuel mixture to make starting a cold engine easier. Use the FULL CHOKE position when starting a cold engine; switch to PARTIAL CHOKE (Half Choke) for a few seconds once the engine is started; use the NO CHOKE position when warming up the engine and during general operation. The lever has an "arrowhead" shape — the point of the arrow indicates the direction in which the lever must swing for the FULL CHOKE position.

IMPORTANT — If engine falters when the choke lever is in the NO CHOKE position, switch back to PARTIAL CHOKE temporarily. ALWAYS HAVE THE CHOKE LEVER IN THE NO CHOKE POSITION DURING GENERAL OPERATION. Harmful deposits will build up inside the engine if you don't do this.

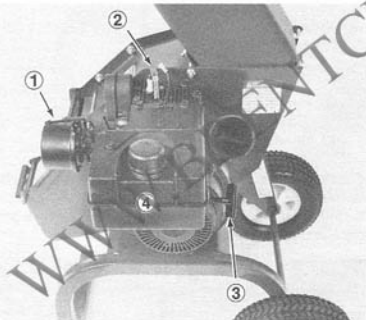

(Photo 3-9) Controls on the 3 HP Tecumseh engine: Choke Lever ("1"); Shut-Off Tab ("2"); Recoil Starter ("3"); Fuel Tank ("4").

2. Engine Shut-Off Tab

This Tab, located on the top of your engine next to the spark plug (see Photo 3-10), must be used to shut off the engine. To use it, simply hold the Tab against the spark plug until the engine stops completely. The ideal operating speed for your engine has been pre-set at the factory by the engine manufacturer, allowing your engine to always provide sufficient power to the Chipper/Shredder regardless of the type of job it's doing. **Please do not alter the pre-set engine speed in any way.** A higher speed could damage it.



(Photo 3-10) Engine Shut-Off Tab. Push against spark plug to stop the engine.

3. Manual Recoil Start Rope

Your Manual Start engine has a rope-pull recoil starter. To use this feature, grasp the starter rope handle (see Photo 3-11) and slowly pull the rope until you feel resistance. . . then pull the rope out rapidly to start the engine. Always let the starter rope back in slowly to prevent damage to the recoil assembly. You may have to pull the starter rope several times to start a cold engine.

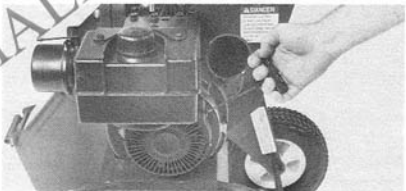

(Photo 3-11) To start the engine, pull out the starter rope. Let the starter rope back in slowly once the engine is running.

4. Engine — Fuel Tank

⚠ WARNING

WHEN FILLING FUEL TANK, ENGINE MUST BE OFF. GASOLINE AND ITS VAPORS ARE HIGHLY FLAMMABLE AND EXPLOSIVE. USE EXTREME CAUTION WITH GASOLINE TO PREVENT PERSONAL INJURY.

KEEP SPARKS, FLAME AND SMOKER'S MATERIALS AWAY FROM FUELING AREA. LEAVE ½" AIR SPACE AT TOP OF FUEL TANK FOR GASOLINE EXPANSION. WIPE UP ANY GASOLINE SPILLS BEFORE STARTING THE ENGINE.

Be sure to use gasoline that meets the specific requirements in the engine manufacturer literature. Recommended is Unleaded Regular automotive gasoline. Leaded Regular is an acceptable substitute. The fuel tank on your engine is located on the upper right hand side (see Photo 3-9).

SECTION 4: OPERATING INSTRUCTIONS

⚠ DANGER

CONTACT WITH ROTATING CUTTING BLADES INSIDE DISCHARGE OPENING WILL CAUSE SERIOUS PERSONAL INJURY!

READ THE COMPLETE OWNER/OPERATOR MANUAL, INCLUDING THESE OPERATING INSTRUCTIONS, BEFORE USING YOUR EQUIPMENT.

This Section provides you with detailed information on the use of your Chipper/Shredder, lots of helpful tips to make jobs go faster and smoother, and an important Checklist of Pre-Starting Steps and Engine Starting Steps that you should always use. **Please read all of the information in this Section before you start the engine.** **IMPORTANT — Do not allow processed material to build up beneath the machine or in the Discharge Area.** If material can not freely exit via the discharge opening, it will continue to circulate within the processing chamber leading to clogs and the possibility of having some of the material being “blown” back up through the feed hopper.

To remove discharged material or blockages, push Engine Shut-Off Tab (on top of engine) against spark plug and hold there until all moving parts have come to a complete stop. Disconnect the spark plug wire. Then, use a long-handled shovel or stick to move material from beneath and around discharge area. With machine still turned off, check that the holes in the screen are not clogged. To do this, just open the Service Door and inspect the screen as shown in Photo 3-6. Clean out any clogged holes with a small stick.

Use The Shredder For Most Materials; Use The Chipper For Big Tough Jobs

To get the greatest benefits from your equipment, it's important to know which materials are best fed into the Shredder hopper and which ones are best fed into the Chipper chute. **Under no circumstances should you feed metal, glass, bottles, plastic, cans, rocks or other such foreign objects into your equipment. Please see examples of appropriate materials for chipping and shredding listed below.**

IMPORTANT — Do not shred materials thicker than 1/2" in diameter — engine damage could result.

Materials Best Suited For Shredding:

Due to the wide variety of materials that can be shredded, and their very different physical characteristics, **we suggest that you feed limited quantities of any material to begin with.** Bulk and lengths can be increased if you find the material is being processed without any difficulty. Your judgement is important — *be sure not to overload the Shredder.* Overloading will

cause engine speed to decrease significantly. Always feed material slowly into the shredder.

- Twigs and branches — up to 1/2" in diameter in the Shredder hopper. Several small branches can be fed into the Shredder hopper at once providing their combined diameter is less than 1/2". Long branches (more than 2-to-3 feet) should be cut to make them more manageable. Green materials should be allowed to dry, or processed in small batches with dry materials, to avoid winding up and binding the cylinder.
- Leaves, grass clippings, and all other light, loose materials. These process most easily.
- Organic waste materials and organic garbage (be sure to first remove all metal bottles, cans, rocks, and plastic).
- Sections of vines less than 1/2" in diameter. Long vines should be cut to manageable lengths — 2-to-3 feet.
- Wood chips processed by the Chipper if even finer particles are required.
- All paper trash.
- Partially finished compost.
- Stalks and most brush material.
- A mixture of any of the materials listed above.

Materials Best Suited For Chipping:

- Thicker branches — from 1/2" to 2" in diameter, depending upon the hardness of wood. Extremely hard knots will not process very well. Short, thick branches (up to 2" in diameter) that are left over after an original longer branch was fed through the chipper may also be chipped — move these shorter stubs through the chipper with the next long branch you'll be chipping.
- Tough 1/2" to 2" diameter stalks and vines. Cut them to manageable lengths — no more than five or six feet long — before chipping them.

⚠ DANGER

CONTACT WITH ROTATING CUTTING BLADES INSIDE THE UNIT AND INSIDE THE DISCHARGE OPENING WILL CAUSE SERIOUS PERSONAL INJURY. THE CHIPPER AND SHREDDER BLADES ROTATE AT EXTREMELY HIGH SPEED.

NEVER PUT YOUR HANDS, FEET OR ANY OTHER PART OF YOUR BODY INTO THE CHIPPER CHUTE INLET OR SHREDDER HOPPER INLET. KEEP HANDS AND FEET OUT OF DISCHARGE OPENING WHEN MACHINE IS RUNNING. BEFORE SERVICING OR UNCLOGGING JAMMED MATERIAL, PUSH SHUT-OFF TAB (On Top Of Engine) AGAINST SPARK PLUG AND HOLD THERE UNTIL ALL MOVING PARTS HAVE COME TO A COMPLETE STOP. DISCONNECT THE SPARK PLUG WIRE.

Transporting The Chipper/Shredder

When you move your equipment, please follow the instructions below. Remember — the JUNIOR TOMA-HAWK® Chipper/Shredder weighs over 100 pounds. **This weight must be properly balanced over the wheel axle and carefully rolled in order to move the equipment safely and easily.** Here's how:

- First shut the engine OFF. Allow the engine and moving blades to come to a complete stop before proceeding. Then disconnect the spark plug wire.
- Place both hands evenly and firmly on the handle. A good grip is important.
- Place one foot on the wheel axle, halfway between the ends of the axle. Your other foot should be firmly planted.
- While steadying the equipment with the foot that's on the axle, pull the handlebar toward you (Photo 4-1).
- As the equipment tilts back toward you, stop pulling when you find the balance point and hold the equipment there. Take your foot off the axle.
- Slowly pull or push the Chipper/Shredder to the work area. Be sure the path is clear and you keep a firm grip on the handle. On smooth, level ground, it's easier to push the unit. Pulling is better over uneven ground.
- At your destination, make a complete stop. Then put your foot back on the axle to steady the wheels and tip the machine forward slowly until the front stand touches the ground. Remember — your equipment should only be used on an earthen, level surface... not on hard driveways, patios or gravel where discharged materials can bounce back up.



(Photo 4-1) To move your Chipper/Shredder, plant one foot on the axle, tilt equipment back with both hands until "balance point" is reached, then push or pull your equipment to a work area. Engine must be OFF.

Pre-Starting Steps

1. Engine must be OFF. Disconnect the spark plug wire temporarily. Move your equipment to an earthen, level surface... never a hard surface.
2. Check the engine for correct oil level.
3. Add gasoline to the fuel tank, if needed. Follow safety requirements in Section 1.
4. Be sure all bystanders are at least 25 feet away from the area of operation.
5. Put on your safety goggles, sturdy work gloves and hearing protectors.
6. Visually check the Chipper Chute and the Shredder Hopper to see that they're empty.
7. Check the Discharge Screen (or Wet Material Baffle Attachment) to be sure it's securely attached. The screen holes must not be clogged. If clogged, clean them with a stick. Be sure all hardware is securely fastened. Check that all shields and guards are in place and secure, including the Service Door.
8. Reconnect the spark plug wire. You are now ready to start the engine.

⚠ DANGER

ROTATING SHREDDER CUTTING BLADES CUT WITHIN 1/4" FROM THE DISCHARGE SCREEN. NEVER PUT YOUR HANDS OR FEET NEAR THE DISCHARGE OPENING OR AREA WHILE THE MACHINE IS OPERATING. CONTACT WITH BLADES WILL CAUSE SERIOUS INJURY.

IF SHREDDED MATERIAL BUILDS UP BENEATH THE MACHINE DURING OPERATION, USE A LONG STICK OR LONG-HANDLED SHOVEL TO MOVE THE MATERIAL OUT OF THE WAY — NEVER USE YOUR HANDS OR FEET.

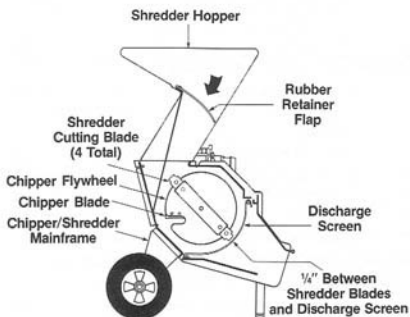

Shredder blades pass within 1/4" of discharge screen — KEEP HANDS AND FEET AWAY from the Discharge opening and keep the Service Door closed and secured with the rod and hairpin.

Engine Starting & Stopping Steps

▲ DANGER

ROTATING CUTTING BLADES INSIDE THE CHIPPER/SHREDDER CHAMBER ARE IN OPERATION ONCE THE ENGINE IS STARTED. CONTACT WITH CUTTING BLADES WILL CAUSE SEVERE INJURY.

KEEP HANDS, FEET, FACE AND CLOTHING OUT OF SHREDDER INLET AND CHIPPER INLET, AND AWAY FROM DISCHARGE AREA AT ALL TIMES.

How To Start:

1. Move the Carburetor Choke Control Lever to FULL CHOKE Position (see Photo 3-9) if the engine is being started "cold."
2. Grip the Starter rope handle securely (Photo 3-11). Pull the rope out slowly until you feel resistance. Then quickly pull the starter rope firmly all the way out to start the engine. Several attempts may be needed.
3. Once the engine starts, let it warm for a few seconds with the Choke Lever in "Full" position. Then move the choke to "Partial" position for a few seconds — finally move the choke to "No Choke." As soon as the engine starts, the cylinder assembly holding the shredder flail cutter blades and the chipper disc holding the chipper blade start to revolve. In a few seconds the blades will be at full speed — 3600 RPM!

How To Stop:

4. **STOP** — Move the Shut-Off Tab up against the spark plug and hold it there until the engine has stopped completely. **LISTEN** — Remove hearing protection. Be certain that all moving parts have stopped completely.

How To Use The Chipper

After the engine is started, the chipper blade will rotate at 3600 revolutions per minute. Be sure to wear approved safety goggles, gloves and hearing protection.

Position yourself directly in front of and a couple of feet away from the Chipper Feed Chute (see Photo 4-2). The chipper will process branches from 1/2" to 2" in diameter. To reduce branches to small chips, simply grip one end of a branch firmly with both hands and feed the other end of the branch into the chipper chute. **Keep the branch away from your body to avoid any bounceback, and don't overreach.** Hold the branch firmly so you can control the rate of feed at all times (see Photos 4-3 and 4-4).

All branches should be *evenly rotated* when fed into the chipper. This will help to prevent the bark from turning into long strips or strings that can get tangled

around the internal drive shaft. Removing tangles is time-consuming as the machine must be shut off, so please rotate branches.



(Photo 4-2) Feed material into chipper at proper angle, and rotate branches. Do not overload the chipper.



(Photo 4-3) Hold branches firmly; feed in smoothly.

▲ DANGER

CONTACT WITH ROTATING CUTTING BLADES INSIDE THE UNIT WILL CAUSE SERIOUS PERSONAL INJURY. BLADES ROTATE WHEN ENGINE IS ON, AND STOP AFTER ENGINE IS SHUT OFF.

KEEP HANDS, FEET, FACE AND CLOTHING OUT OF THE CHIPPER CHUTE INLET AND SHREDDER HOPPER INLET, AND AWAY FROM THE DISCHARGE OPENING WHEN MACHINE IS RUNNING.

Feed the branch into the chipper chute until just a few inches stick out from the chute. **NEVER put your hands into the chipper chute. Short stubs of branches may be pushed through the chipper with the next**

branch. Pay close attention to engine speed. If the engine slows down, reduce feed pressure and let the engine build up to full speed again before continuing. Avoid overloading the chipper.



(Photo 4-4) If engine speed starts to slow, reduce feed pressure and let engine speed build up.

How To Use The Shredder

Once the engine on your equipment has been started, the flail cutting blades inside the cutting chamber revolve at a high rate of speed and the Shredder is ready to use. Of course, you must wear safety goggles, work gloves, and hearing protection.

Stand 1-to-2 feet from the Shredder Feed Hopper — don't stand where the hot engine muffler is located. See Photo 4-5 for correct position. You'll see the safety decal, the operating instructions decal, and rubber retaining flap in the feed hopper. Have your Leaf Tamper handy if you're going to process loose materials.



(Photo 4-5) When using the Shredder, stand 1-to-2 feet away from the top-loading hopper and release materials into it.

⚠ DANGER

CONTACT WITH ROTATING CUTTING BLADES INSIDE THE UNIT WILL CAUSE SERIOUS PERSONAL INJURY.

KEEP HANDS, FEET, FACE AND CLOTHING OUT OF THE CHIPPER CHUTE INLET AND THE SHREDDER HOPPER INLET, AND AWAY FROM THE DISCHARGE OPENING WHEN MACHINE IS RUNNING.

A steady flow of materials into the Shredder Feed Hopper provides the most effective results. See Photo 4-5. The feed rate for branches, vines and brush can be controlled by lightly pushing and guiding the far end of material until it extends above the top of the hopper. At this point, **LET GO OF THE MATERIAL**. It's best to cut long branches and vines into more manageable 2-to-3 foot lengths.

IMPORTANT — The shredder blades can tug suddenly at material being fed into the Shredder Feed Hopper, so don't hold on tightly to branches and vines, and don't feed material straight down into the hopper with your arm pointing downward toward the opening. Instead, keep your arm parallel to the ground and several inches above the top edge of the hopper.

Also: don't put any part of your body or clothing inside the hopper or near the discharge area; stand clear of the discharge area; and keep face and body out of the Shredder inlet, out of the discharge opening, and away from the discharge area.



(Photo 4-6) Feed materials in steadily and slowly, but don't overload the shredder. Your Leaf Tamper can hang conveniently on the shredder handle, ready for use.

Under certain conditions, it may become necessary to push bulky material into the Shredder Feed Hopper. **DO NOT USE YOUR HANDS** — Instead, use your Leaf Tamper, or a small diameter stick of a size that will be shredded if it contacts the rotating cutting blades.

When you have loose materials to process, such as leaves or grass clippings, just drop them into the hopper opening. Use a stick or tamper to push this material past the rubber retaining flap. See Photo 4-6 and Photo 4-7. Do not allow combustible materials to contact the engine.

IMPORTANT — If the engine slows down while feeding material, stop right away and give the engine time to come up to full speed.

Feed the shredder slowly. Materials and conditions vary considerably. After a learning period, you will know how to process different materials best.



(Photo 4-7) Use your Leaf Tamper to push loose materials into the shredder-chamber. Position the Tamper so the "stop" faces UP as shown in the photo. The "stop" prevents the Tamper from going too far in.

⚠ DANGER

THE DISCHARGE AREA AND DISCHARGE OPENING ARE DANGEROUS. SEE SECTION 1 FOR SAFETY INSTRUCTIONS TO AVOID INJURY.

All shredded materials will be discharged through the opening which is at the side of your equipment, near the bottom. See Photo 4-8. Always keep clear of the discharge opening since the materials exit with considerable velocity. The standard discharge screen that came with your Chipper/Shredder is a perforated screen with $\frac{3}{4}$ " holes. This screen is generally best for making compost.

NOTE: Wet, green, gummy material should not be used in the Shredder with the standard $\frac{3}{4}$ " Discharge Screen — it will very quickly become clogged. We strongly recommend that you use the Wet Material Baffle Attachment in place of the standard screen for material like this.



(Photo 4-8) Finely shredded material ready to use.

Shredding Wet, Soggy, or Green Materials

Wet or green materials (such as wet, matted leaves, gone-by vegetables, green vegetation like squash vines, etc.) will clog the $\frac{3}{4}$ " holes of the standard discharge screen.

Before shredding these types of materials, shut engine off, let all moving parts come to a complete stop, and disconnect spark plug wire; then remove the discharge screen from the machine, install the Wet Material Baffle as explained on page 9, and secure the service door with its rod and hairpin clip. You can now shred wet or green materials.

These types of materials will be shredded to a fine consistency when you follow this procedure. If you

prefer an even finer consistency, you may wish to process the material a second time. **NOTE:** green cornstalks will be shredded into 3-4" chunks; reprocessing is recommended if you desire a finer material.

DO NOT use the optional Collection Bag when shredding wet or green material — doing so will cause clogging.

⚠ DANGER

WITH DISCHARGE SCREEN REMOVED, DO NOT SHRED BRUSH, BRANCHES, OR OTHER DRY MATERIALS — THEY WILL EXIT THE DISCHARGE OPENING AT HIGH SPEED.

SECTION 5: MAINTENANCE & SERVICE

Engine Maintenance/Service

Your TROY-BILT® SUPER TOMAHAWK Chipper/Shredder is equipped with a 3 HP Tecumseh engine. It is four-cycle, air-cooled, and gasoline powered. **DO NOT MIX OIL WITH YOUR GASOLINE.** Read and follow all of the service and maintenance information given here and in the accompanying engine manufacturer literature to keep the engine running at peak performance. If you need engine repairs or parts, contact your local authorized Tecumseh dealer for assistance. The dealer will need to know the engine identification numbers to help you. The Tecumseh engine has MODEL and SERIAL NUMBERS. They are located on top of the engine blower housing, near the spark plug, per Photo 5-1.



(Photo 5-1) Location of Tecumseh engine I.D. numbers.

⚠ WARNING

MOVING PARTS ON YOUR EQUIPMENT CAN CAUSE SERIOUS PERSONAL INJURY.

BEFORE MAINTENANCE OR SERVICE PROCEDURES ARE PERFORMED, PUSH SHUT-OFF TAB (On Top Of Engine) AGAINST SPARK PLUG AND HOLD THERE UNTIL ALL MOVING PARTS HAVE COME TO A COMPLETE STOP. DISCONNECT THE SPARK PLUG WIRE.

Change Engine Oil As Recommended

Remember to *check* the engine oil level prior to each usage and at least every two hours during continuous operation. The oil level must always be up to the top of the oil fill tube on the 3 HP Tecumseh engine.

Oil Change Schedule For Your Engine

Initial Oil Change — After First 2 Hours of Operation
Schedule Thereafter — Every 10 Hours of Operation

To Change The Engine Oil:

1. Run the engine a few minutes to warm the oil. Then stop the engine and disconnect the spark plug wire.
2. The Tecumseh engine has two oil drain plugs on opposite sides of the engine near the engine base. Either drain plug may be used. See Photo 5-2.

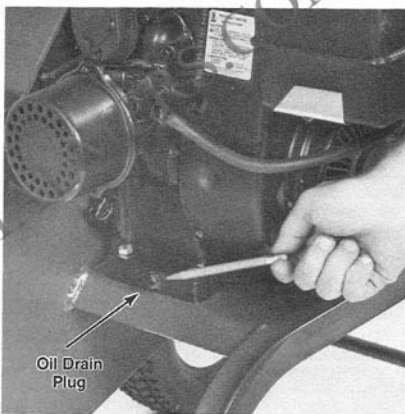

(Photo 5-2) Left-side oil drain plug on Tecumseh engine.

3. Clean thoroughly around the Oil Fill Cap, then remove the fill cap to vent crankcase for fast drainage. Also — prop up the footstand with a wood 2" x 4" to aid in draining the oil.
4. Place an oil collection pan beneath the Oil Drain Plug. Now remove the drain plug and allow all the dirty oil and sludge to drain out completely. Replace the drain plug — put gasket sealant on the threads.
5. You're now ready to add fresh oil. Add motor oil until the level is right up to the top of the Oil Fill Tube (about 21 ounces — see Sketch 2-4). Replace the oil fill cap.
6. Start the engine outdoors and let it warm up. Check the level again after shutting the engine off, and be sure there is no leakage around the drain plug. If leaking, tighten it.

Air Cleaner Service

The air cleaner prevents dirt and dust from entering the engine through the carburetor. It is very important that the air cleaner filter be replaced if dirty, and properly installed at all times. This will prevent premature wear or damage to the engine. A clean filter also avoids starting and overheating problems.

3 HP Tecumseh Air Filter Service Schedule & Replacement Procedure:

Service Schedule — Inspect filter every 10 operating hours, sooner if needed. See engine literature for full instructions. Replace the filter annually, or more often with extremely dusty or dirty conditions.

To Replace Air Filter — 1) Loosen both outer screws holding air cleaner cover in place; 2) Twist cover to the left, then remove cover with the air filter inside it (see Photo 5-3); 3) Check tightness of mounting screws on back mounting plate (Photo 5-4); 4) Clean the back plate and the outer cover, then install the new air filter and reassemble the components.

Areas To Be Kept Clean

Your equipment has an air-cooled engine, so it is important that air be able to circulate freely to keep the engine cool while running. Always remove dirt, grass and debris from the following areas: the cooling fins; engine covers; the air intake screen just behind the starter rope. Use a brush for thorough cleaning regularly. See Photo 5-5 for reference. Also keep the air holes in the center of the front cover of your machine clean. Always shut off the engine, make sure all parts have stopped completely, and disconnect the spark plug wire before cleaning these air holes. Use a small wire or piece of coat hanger to unclog the air holes.

Spark Plug And Ignition System Information

3 HP Tecumseh Specifications — Use a Champion J-8 or the equivalent. Proper electrode gap is .030". (Note: Canadian owners must use a Champion RJ-17LM Resistor Plug to comply with government standards). Do not blast clean the spark plug. If spark plug is damaged or badly worn, please install a new plug. Your engine has a dependable, maintenance-free solid-state ignition, eliminating the need for points and condenser.

For further information on spark plugs and ignition systems, see separate engine manufacturer literature.



(Photo 5-3) Air cleaner outer cover and air filter.



(Photo 5-4) Tecumseh air cleaner back mounting plate. Check to see both screws are secure.

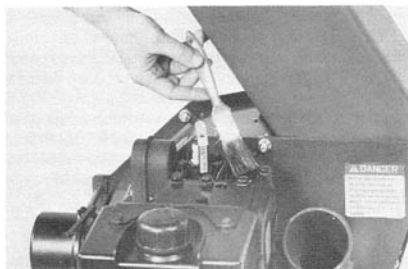

(Photo 5-5) Keep the engine cooling fins clean.

Carburetor Adjustment, Engine Storage & Other Engine Maintenance/Service

Please refer to the engine manufacturer brochure which was included in your literature package for further details and coverage on topics such as carburetor adjustment, etc. Remember: your closest authorized engine dealer is fully equipped to handle all repairs, parts orders and engine warranty service.

Chipper/Shredder Maintenance And Service

⚠ WARNING

MOVING PARTS ON YOUR EQUIPMENT CAN CAUSE SERIOUS PERSONAL INJURY.

BEFORE MAINTENANCE OR SERVICE PROCEDURES ARE PERFORMED, PUSH ENGINE SHUT-OFF TAB (On Top of Engine) AGAINST SPARK PLUG AND HOLD THERE UNTIL ALL MOVING PARTS HAVE COME TO A COMPLETE STOP. DISCONNECT THE SPARK PLUG WIRE.

Lubrication Recommendations

An all-purpose spray-type lubricant should be used a couple of times a year to keep moving parts in good condition and operating smoothly. Apply lubricant to these areas: 1) the Service Door; 2) the wheel hubs. *NOTE: A good quality grease containing a metal lubricant may be substituted for the spray-type lubricant.*

The Shredder Flail Cutting Blades — Rotation of Cutting Edges & Blade Replacement;

The Chipper Blade — Sharpening Or Replacement

The four free-swinging shredder cutting blades inside the housing do all the shredding. Because of the constant grinding action they provide, they're subject to wear. To lengthen their lifespan, these blades have been designed with four cutting surfaces (one at each corner) — only one cutting surface on each blade is working at any given time. When that edge gets dull, just rotate the blade so one of the three other fresh edges gets used (see Illustration 5-6). When all four edges become dull, it's time to replace the shredder flail blade. Directions on how to inspect, then rotate or replace, the blades follow.

The chipper blade may also be removed for sharpening, or replaced if it is damaged. Instructions follow.

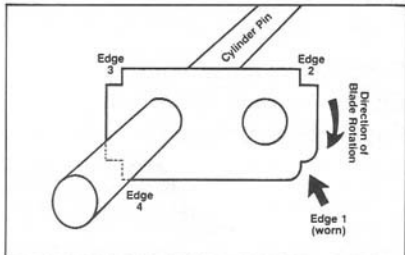

(Illustration 5-6) There are four cutting edges on each of the four shredder flail cutting blades. When one edge gets dull, the blade can be rotated.

To inspect and rotate cutting edges on the shredder blades (or to replace the blades), follow these instructions:

1. Push engine Shut-Off Tab (On Top of Engine) against spark plug and hold there until all moving parts have stopped completely. Disconnect the plug wire.

Tools Required: Pliers; Two 1/2" Wrenches; 5/16" Wrench; 1/4" Hex Key Wrench; Drift Pin; Mallet; Loctite 242 Thread Lock Sealant; Work Gloves.

2. Remove the hair pin clip from the lower rod securing the service door. Then slide the rod out, which allows you to lift the service door. Put the rod and hair pin clip aside for now. See Photo 5-7.

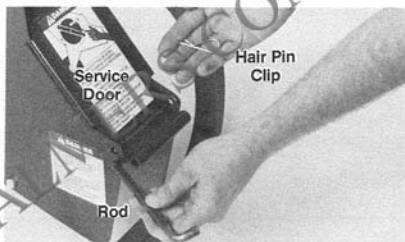

(Photo 5-7) To open the service door, remove the hair pin clip and slide out the rod securing the bottom of the door. Put hardware aside for now.

3. Remove the internal Discharge Screen (or the Wet Material Baffle if it's installed in place of the Discharge Screen). Simply pull out the two hair pin clips and slide out the two rods that secure the front and back of the discharge screen. (Or remove the one rod and hair pin clip securing the baffle). Lift the service door and carefully slide the discharge screen out toward you (notice the difference between the two screen ends — the end that's bent back on itself the most goes in first during the reassembly) and put it aside. See Photo 5-8.



(Photo 5-8) Remove the Discharge Screen. First, pull out the two hair pin clips and slide out the two rods securing the discharge screen. While holding up the service door slide the screen out and put it aside with its hardware. Note how the screen ends are different — during reassembly, the end that's bent back the most goes in first.

4. Before removing any further parts, inspect the condition of the flail cutting blades. Use a flashlight to examine them by looking into the service door opening or the discharge area opening. You'll see two free-swinging blades, separated by a spacer, on each of two cylinder pins.

⚠ DANGER

BEFORE PERFORMING THE FOLLOWING PROCEDURE, BE SURE TO DISCONNECT THE SPARK PLUG WIRE.

If any of the four blades is difficult to see, simply pull out the starter rope a little to cause the rotor/blade assembly to turn — watch your fingers because the shredder flail blades and the chipper blade are extremely sharp! While you're looking inside, inspect the chipper blade for nicks and cracks. If the cutting edges seem to be in good condition, your inspection is complete. Refer to Photo 5-9. If one or more shredder blades is worn or any spacers are damaged, or the chipper blade must be removed, continue on with Step 5.

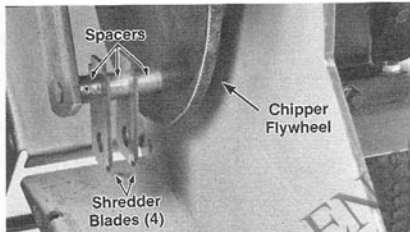

(Photo 5-9) Inspect the flail cutter blades and the spacers between them. Also look at the chipper blade while you're at it. The chipper blade is secured to the rotor flywheel with two bolts.

5. If shredder flails are to be replaced or rotated, or the chipper blade is to be sharpened or replaced, you must now remove the cover plate from your equipment. This plate is secured with twelve (12) bolts and nuts. Remove all hardware as shown in Photo 5-10. Use two $\frac{1}{2}$ " wrenches. Once the hardware is off, remove the cover plate and set it aside.

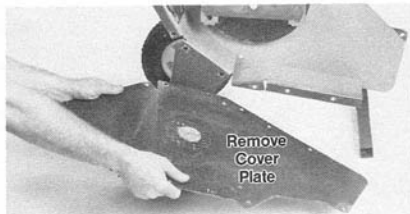

(Photo 5-10) Remove 12 bolts securing cover plate to the main housing. Take cover plate off.

6. Also remove the service door. Now that the cover plate is off, the service door is no longer secured with hardware — just take it off and put it aside.

7. The rotor assembly that holds the shredder blades and chipper blade is secured to the engine's power shaft. To remove the rotor assembly, first insert a block of wood to prevent rotor movement, then use a $\frac{9}{16}$ " wrench to loosen the $\frac{3}{8}$ " bolt and lockwasher shown in Photo 5-11 and use the hex key wrench provided to loosen the two set screws in the rotor hub (see Photo 5-11). You can now slide off the rotor. Don't lose the loose spacer and shim(s) located inside the hub, or the key. They'll be needed later.

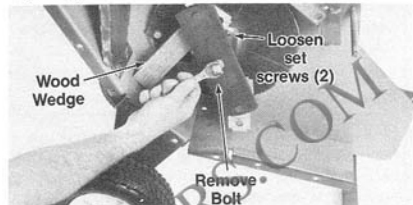

(Photo 5-11) Take off the rotor assembly to work on the shredder flail cutting blades or the chipper blade. Remove the bolt and lockwasher at the end of the rotor and loosen the two set screws in the rotor hub. Slide the rotor assembly off the engine shaft. Don't lose the loose spacer, shim(s) or the shaft key.

8. To rotate or replace any of the shredder flails, go to the flail you wish to replace, then use your mallet and drift tool to drive out the small roll pin that holds the blades and spacers on the cylinder pin. After the roll pin is out (don't reuse it... throw it away), the cylinder pin can slide and the flails and spacers will come off. Refer to Photo 5-12.

IMPORTANT — Be sure to note the exact placement of the blades (and spacers between them) before sliding the cylinder pin out. The blades and spacers must be reassembled the same way!

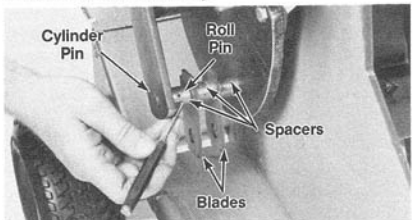

(Photo 5-12) Use a mallet and drift pin to knock out the roll pin that secures the blade(s) and spacers you want to remove or rotate. Throw away the old roll pin. With the roll pin out, you can slide the cylinder pin out so the blades and spacers will come off one at a time. Rotate the dull blade or replace it if all 4 edges are dull. Reassemble the same way. Always use new roll pins. Apply two beads of Loctite 242 sealant on opposite sides of the roll pin and drive the roll pin back in securely. Let the sealant set for 24 hours before using your shredder.

Any blade that is worn on one corner can now be turned end-to-end or just flipped over so a new cutting edge is in position. Or replace the blade with a new one if all the cutting edges are dulled. Carefully reassemble the flails and spacers on the cylinder pin. Apply Loctite 242 sealant to a new roll pin, then drive the roll pin back in securely. Repeat this procedure if any of the blades on the other cylinder pin need to be rotated or replaced. Let the Loctite sealant cure for 24 hours before using the shredder.



CAUTION

CHIPPER BLADE IS EXTREMELY SHARP AND CAN CAUSE PERSONAL INJURY.

AVOID CONTACT WITH THE BLADE EDGE. HANDLE THE BLADE CAREFULLY.

9. Now is the time to take off the chipper blade if it needs sharpening or it's to be replaced with a new blade. Be very careful not to cut yourself on this sharp blade. Use a $\frac{1}{2}$ " wrench to take out the two $\frac{9}{16}$ " - 18 x $\frac{5}{8}$ " long Grade-8 bolts that secure it to the flywheel. The hardened blade should be **professionally** sharpened at a 45-degree angle. Install a new blade if the old one is cracked or badly nicked. Tighten the hardware to 16-to-18 foot-pounds of torque when installing the blade on the flywheel.

10. Slide the spacer and then the shim(s) into the rotor assembly hub and put the rotor assembly back on the engine shaft (don't forget the key goes in the shaft keyway!). Move the rotor assembly on the engine shaft as far as it will go — use a feeler gauge to see that the chipper blade is between $\frac{1}{16}$ "-to- $\frac{3}{32}$ " away from the anvil next to it. See Photo 5-13. Add or subtract shims in the rotor hub to obtain this required clearance.

11. Apply Loctite 242 to the threads of the bolt that goes

on the end of the engine shaft. Install the bolt and lockwasher which secure the rotor assembly to the shaft. Tighten to 32 foot-pounds (± 5 lbs.) of torque. Block the rotor to prevent it from moving while you tighten the bolt.

12. Apply Loctite 242 to the threads of both set screws that go through the rotor hub. Use your hex key wrench to securely tighten these screws.

13. Mount the service door back in position (refer back to Photo 5-8). **Never operate your equipment unless the service door is installed and secured!**

14. Install the cover plate on the housing, using the twelve bolts and nuts you took out previously. Be sure this hardware is securely tightened.

15. Put the discharge screen back in the housing. The more tightly crimped end goes in first. You'll need two rods and two hair pin clips to secure the screen; one rod and hair pin clip for the baffle. Refer back to Photo 5-8 for assistance. It's extremely important the screen (or baffle attachment) be installed properly.

16. Insert a rod to secure the bottom of the service door. Be sure to lock the rod with the hair pin clip. See Photo 5-7.

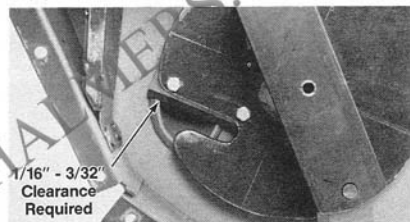

(Photo 5-13) Chipper blade must be from $\frac{1}{16}$ "-to- $\frac{3}{32}$ " (.050"-to-.090") away from the anvil next to it. Use a feeler gauge to check the distance. Add or subtract shims inside the rotor hub to create this clearance.

SPECIFICATIONS

JUNIOR TOMAHAWK® CHIPPER/SHREDDER

Chipper/Shredder Specs

Chipping/Shredding Capability:	Up to ½" diameter material in shredder hopper. ½"-to-2" diameter material in chipper chute.
Frame Construction:	Heavy-gauge steel.
Shredder Flail Cutter Blades:	Four hardened steel blades, each with four cutting edges.
Chipper Blade:	Hardened steel blade (revolves at 3600 RPM).
Overall Measurements:	Length — 25" Width — 23" Height — 40¼"
Weight:	115 lbs.
Wheels:	10½" x 3½", plastic (gray or beige)

Tecumseh Engine Specs

Manufacturer & General Info:	Tecumseh, Model H-35 manual recoil-start, four-cycle, single-cylinder, air-cooled engine. Horizontal crankshaft. Manual choke.
Horsepower rating:	3 HP
Motor Oil Requirements:	Summer — SAE 30 (SAE 10W30 may be substituted). Winter — SAE 5W20 or SAE 5W30. Use Service Classification SF or SE.
Motor Oil Capacity:	21 ounces. Add in Oil Fill Hole at base of engine on Carburetor side.
Fuel Tank Capacity:	2 quarts.
Fuel Recommendations:	Use Unleaded Regular automotive gasoline. Leaded Regular is an acceptable substitute.
Spark Plug:	Champion J-8 or its equivalent. Set gap at .030". Canadian owners use Champion RJ-17LM or equivalent.
Ignition System:	Maintenance-free solid state system. (No need for points or condenser.)
Speed Setting:	3600 RPM (±150 RPM).

FULL NO-TIME-LIMIT WARRANTY

What is Covered:

Your TROY-BILT® TOMAHAWK® Chipper/Shredder is carefully inspected and tested at the factory. We or your Dealer, will repair or replace at no cost to you any part which we find to be defective in materials or workmanship except the engine, which is warranted separately by the engine manufacturer. (Call or write us for a free copy of the engine warranty.)

This FULL NO-TIME-LIMIT WARRANTY also applies to all attachments for the TOMAHAWK® Chipper/Shredder. Note: Warranty for commercial use is limited to one year from the date of purchase.

How to Get Service:

To obtain warranty service, write to: Troy-Bilt Manufacturing Company, 102nd Street & 9th Avenue, Troy, NY 12180 or call (toll free) 1-800-833-6990, or consult your Yellow Pages for the name of your closest Troy-Bilt Dealer.

Your Rights Under State Law:

This warranty gives you specific legal rights, and you may also have other rights which vary from state to state.

Troy-Bilt Manufacturing Company 102nd Street & 9th Avenue, Troy, NY 12180
Call Toll-Free 1-800-833-6990

Garden Way Canada, Inc. 1515 Matheson Blvd., Unit B11, Mississauga, Ontario L4W 2P5
From Ontario and Quebec, call 1-800-387-3351
From Western Canada and Maritime Provinces, call 1-800-387-3316
Local Only (416 Area), call 624-8423